



SM55G Series 3.3 V CMOS Clock Oscillators

April 2010

Lead Free 

- Pletronics' SM55 Series is a quartz crystal controlled precision square wave generator with a CMOS output.
- The package is designed for high density surface mount designs.
- This is a low cost mass produced oscillator.
- Tape and Reel or cut tape packaging is available.
- 0.8 to 160 MHz
- 3.2 x 5 mm LCC Ceramic Package
- Enable/Disable Function
- Disable function includes low standby power mode
- Low Jitter
- Optimized for larger load applications

**Pletronics Inc. certifies this device is in accordance with the
RoHS 6/6 (2002/95/EC) and WEEE (2002/96/EC) directives.**

Pletronics Inc. guarantees the device does not contain the following:
Cadmium, Hexavalent Chromium, Lead, Mercury, PBB's, PBDE's
Weight of the Device: 0.064 grams
Moisture Sensitivity Level: 1 As defined in J-STD-020C
Second Level Interconnect code: e4

Absolute Maximum Ratings:

Parameter	Unit
V _{CC} Supply Voltage	-0.5V to +7.0V
V _i Input Voltage	-0.5V to V _{CC} + 0.5V
V _o Output Voltage	-0.5V to V _{CC} + 0.5V
I _o Output Current	+25 mA to -25 mA

Thermal Characteristics

The maximum die or junction temperature is 155°C
The thermal resistance junction to board is 30 to 50°C/Watt depending on the solder pads, ground plane and construction of the PCB.

Part Number:

SM55 45 G E V - 75.0M -XX

Part Marking:

Packaging code or blank T250 = 250 per Tape and Reel T500 = 500 per Tape and Reel T1K = 1000 per Tape and Reel
Frequency in MHz
Supply Voltage V_{CC} V = 3.3V ± 10%
Optional Enhanced OTR Blank = Temp. range -10 to +70°C C = Temp. range -20 to +70°C E = Temp. range -40 to +85°C
Series Model
Frequency Stability 45 = ± 50 ppm 44 = ± 25 ppm 20 = ± 20 ppm
Series Model

PFF.FFF M•
YMDxx
or
PFF.FFF M
• YYWWxx
or
PLE SM55
FF.FFF M
• YMDxx
or
P5xYWWx
• FF.FF Mxxx
or
5xYWWxx
FF.FFF M
• PLE xxx

Marking Legend:

PLE = Pletronics
 FF.FFF M = Frequency in MHz
 YYWW or YWW or YMD = Date of Manufacture (year and week, or year-month-day)
 All other marking is internal factory codes

Specifications such as frequency stability, supply voltage and operating temperature range, etc. are not identified from the marking. External packaging labels and packing list will correctly identify the ordered Pletronics part number.

Codes for Date Code YMD

Code	10	1	2	3	4	Code	A	B	C	D	E	F	G	H	J	K	L	M
Year	2010	2011	2012	2013	2014	Month	JAN	FEB	MAR	APR	MAY	JUN	JUL	AUG	SEP	OCT	NOV	DEC

Code	1	2	3	4	5	6	7	8	9	A	B	C	D	E	F	G
Day	1	2	3	4	5	6	7	8	9	10	11	12	13	14	15	16
Code	H	J	K	L	M	N	P	R	T	U	V	W	X	Y	Z	
Day	17	18	19	20	21	22	23	24	25	26	27	28	29	30	31	

Electrical Specification for 3.30V $\pm 10\%$ over the specified temperature range

Item	Min	Max	Unit	Condition
Frequency Range	0.8	160	MHz	
Frequency Accuracy "45"	-50	+50	ppm	For all supply voltages, load changes, aging for 1 year, shock, vibration and temperatures
"44"	-25	+25		
"20"	-20	+20		
Output Waveform	CMOS			
Output High Level	90	-	%	of V_{CC} (See load circuit)
Output Low Level	-	10	%	
Output Symmetry	45	55	%	at 50% point of V_{CC}
Jitter	-	0.6	pS RMS	12 KHz to 20 MHz from the output frequency
	-	2.5	pS RMS	10 Hz to 1 MHz from the output frequency
Enable/Disable Internal Pull-up	50	-	Kohm	to V_{CC}
V disable	-	30	%	of V_{CC} applied to pad 1
V enable	70	-	%	
Output leakage $V_{OUT} = V_{CC}$	-10	+10	uA	Pad 1 low, device disabled
$V_{OUT} = 0V$	-10	+10	uA	
Standby Current I_{CC}	-	3	uA	
Enable time	-	100	nS	Time for output to reach a logic state
Disable time	-	100	nS	Time for output to reach a high Z state
Start up time	-	3	mS	Time for output to reach specified frequency
Operating Temperature Range	-10	+70	°C	Standard Temperature Range
	-20	+70	°C	Extended Temperature Range "C" Option
	-40	+85	°C	Extended Temperature Range "E" Option
Storage Temperature Range	-55	+125	°C	

Typical phase noise plot for 5 oscillators at different output frequencies.

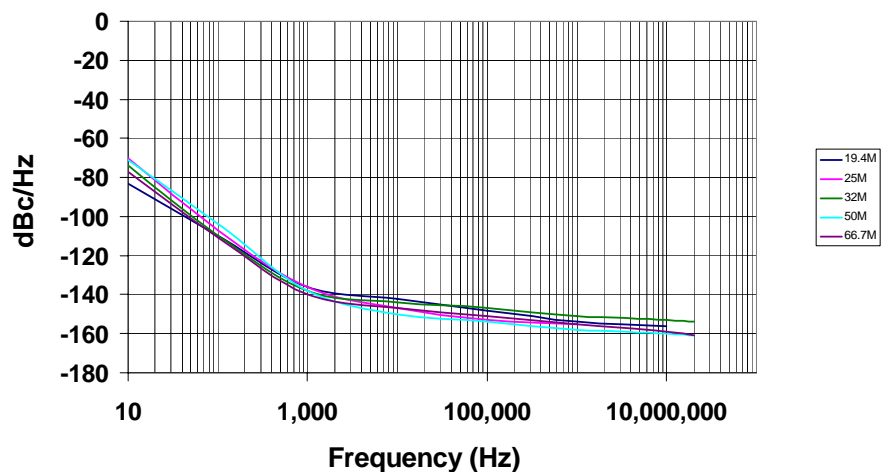

Electrical Specification for 3.30V $\pm 10\%$ over the specified temperature range

Item	Typ	Max	Unit	Condition		
Output T_{RISE} and T_{FALL}	1.5	2.5	nS	< 35 MHz	$C_{LOAD} = 15$ pF 10% to 90% of V_{CC} See Load Circuit	
	1.8	4.0	nS	≥ 35 MHz and < 70 MHz		
	1.2	2.5	nS	≥ 70 MHz and < 110 MHz		
	1	2	nS	≥ 110 MHz		
		3.0	5.0	nS	< 35 MHz	$C_{LOAD} = 30$ pF 10% to 90% of V_{CC} See Load Circuit
		2.5	5.0	nS	≥ 35 MHz and < 70 MHz	
		1.4	3.0	nS	≥ 70 MHz and < 110 MHz	
		1.2	2.0	nS	≥ 110 MHz	
		5.0	8.0	nS	< 35 MHz	$C_{LOAD} = 50$ pF 10% to 90% of V_{CC} See Load Circuit
		4.0	8.0	nS	≥ 35 MHz and < 70 MHz	
		2.1	4.5	nS	≥ 70 MHz and < 110 MHz	
		2.1	3.5	nS	≥ 110 MHz	
V_{CC} Supply Current (I_{CC})	4.5	8	mA	< 8 MHz	$C_{LOAD} = 15$ pF	
	5	9	mA	≥ 8 MHz and < 16 MHz		
	5.5	10	mA	≥ 16 MHz and < 35 MHz		
	13	26	mA	≥ 35 MHz and < 70 MHz		
	20	50	mA	≥ 70 MHz and < 110 MHz		
	30	70	mA	≥ 110 MHz		
		5	9	mA	< 8 MHz	$C_{LOAD} = 30$ pF
		6	10	mA	≥ 8 MHz and < 16 MHz	
		8	13	mA	≥ 16 MHz and < 35 MHz	
		14	28	mA	≥ 35 MHz and < 70 MHz	
		26	57	mA	≥ 70 MHz and < 110 MHz	
		40	90	mA	≥ 110 MHz	
		6	10	mA	< 8 MHz	$C_{LOAD} = 50$ pF
		7	12	mA	≥ 8 MHz and < 16 MHz	
		10	15	mA	≥ 16 MHz and < 35 MHz	
		18	31	mA	≥ 35 MHz and < 70 MHz	
		34	65	mA	≥ 70 MHz and < 110 MHz	
		44	80	mA	≥ 110 MHz	

Specifications with Pad 1 E/D open circuit

Load Circuit and Test Waveform

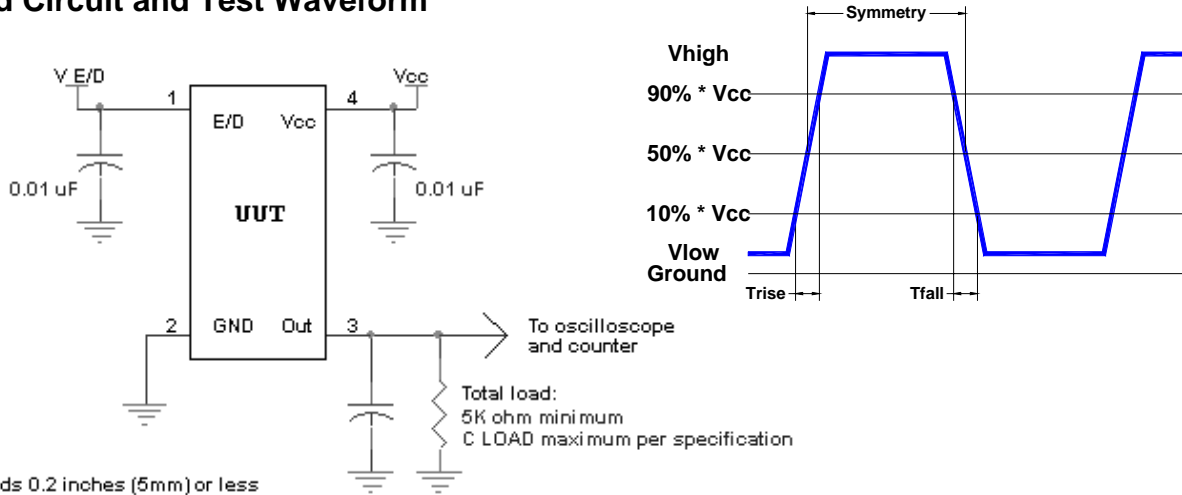

Reliability: Environmental Compliance

Parameter	Condition
Mechanical Shock	MIL-STD-883 Method 2002, Condition B
Vibration	MIL-STD-883 Method 2007, Condition A
Solderability	MIL-STD-883 Method 2003
Thermal Shock	MIL-STD-883 Method 1011, Condition A





ESD Rating

Model	Minimum Voltage	Conditions
Human Body Model	1500	MIL-STD-883 Method 3115
Charged Device Model	1000	JESD 22-C101

Package Labeling

Label is 1" x 2.6" (25.4mm x 66.7mm)
Font is Courier New
Bar code is 39-Full ASCII

Label is 1" x 2.6" (25.4mm x 66.7mm)
Font is Arial

P/N:		
	SM5545GV-25.0M	
Customer P/N:		
	12345678	
Qty:		D/C 
	1000	0632-MMO

RoHS Compliant
2nd Lvl Interconnect
Category=e4
Max Safe Temp=260C for 10s 2X Max

Mechanical:

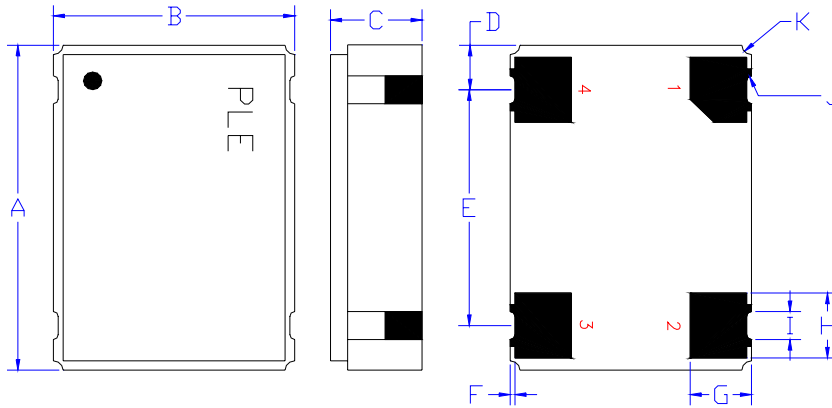

	Inches	mm
A	0.197 ±0.006	5.00 ±0.15
B	0.126 ±0.006	3.20 ±0.15
C	0.045 ±0.004	1.15 ±0.10
D ¹	0.048	1.23
E ¹	0.100	2.54
F ¹	0.004	0.10
G ¹	0.050	1.27
H ¹	0.055	1.40
I ¹	0.024	0.60
J ¹	0.004	0.10R
K ¹	0.008	0.020R

Not to Scale

¹ Typical dimensions

Contacts :

Gold 11.8 to 39.4 μinches (0.3 to 1.0 μm) over Nickel 50 to 350 μinches (1.27 to 8.89 μm)

Pad	Function	Note
1	Output Enable/Disable	When this pad is not connected the oscillator shall operate. When this pad is logic low the output will be inhibited (high impedance state.) Recommend connecting this pad to V _{CC} if the oscillator is to be always on.
2	Ground (GND)	
3	Output	
4	Supply Voltage (V _{CC})	Recommend connecting appropriate power supply bypass capacitors as close as possible.



Layout and application information

For Optimum Jitter Performance, Pletronics recommends:

- a ground plane under the device
- no large transient signals (both current and voltage) should be routed under the device
- do not layout near a large magnetic field such as a high frequency switching power supply
- do not place near piezoelectric buzzers or mechanical fans.

Reflow Cycle (typical for lead free processing)

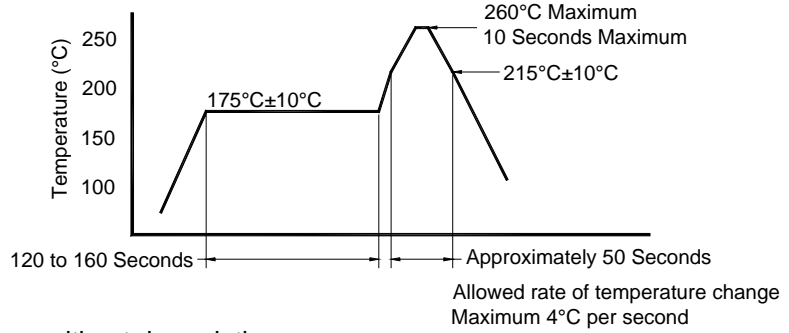

The part may be reflowed 3 times without degradation.

Tape and Reel: available for quantities of 250 to 1000 per reel, cut tape for < 250

Constant Dimensions Table 1								
Tape Size	D0	D1 Min	E1	P0	P2	S1 Min	T Max	T1 Max
8mm	1.5	1.0	1.75	4.0	2.0 ± 0.05	0.6	0.6	0.1
12mm		1.5			2.0 ± 0.1			
16mm		+0.1 -0.0			± 0.1			
24mm		1.5			± 0.1			

Variable Dimensions Table 2							
Tape Size	B1 Max	E2 Min	F	P1	T2 Max	W Max	Ao, Bo & Ko
16 mm	12.1	14.25	7.5 ± 0.1	8.0 ± 0.1	8.0	16.3	Note 1

Note 1: Embossed cavity to conform to EIA-481-B Dimensions in mm Not to scale

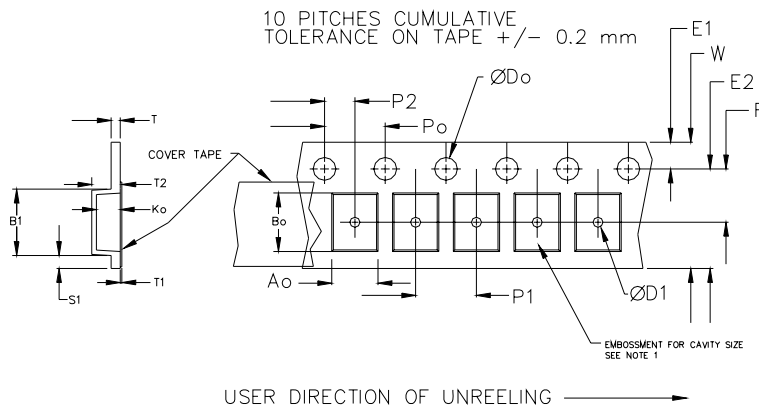
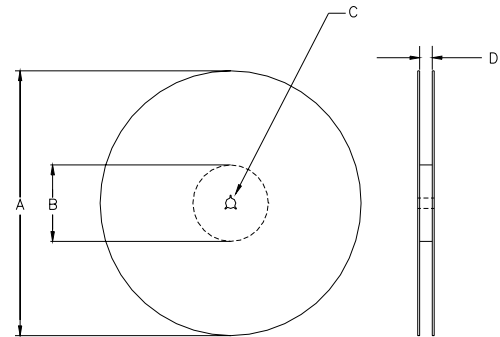

REEL DIMENSIONS					
A	inches	7.0	10.0	13.0	Tape Width
	mm	177.8	254.0	330.2	
B	inches	2.50	4.00	3.75	Tape Width
	mm	63.5	101.6	95.3	
C	mm	13.0 +0.5 / -0.2			Tape Width
D	mm	16.4 +2.0 -0.0	16.4 +2.0 -0.0	16.4 +2.0 -0.0	

Reel dimensions may vary from the above



SM55G Series 3.3 V CMOS Clock Oscillators

April 2010

IMPORTANT NOTICE

Pletronics Incorporated (PLE) reserves the right to make corrections, improvements, modifications and other changes to this product at anytime. PLE reserves the right to discontinue any product or service without notice. Customers are responsible for obtaining the latest relevant information before placing orders and should verify that such information is current and complete. All products are sold subject to PLE's terms and conditions of sale supplied at the time of order acknowledgment.

PLE warrants performance of this product to the specifications applicable at the time of sale in accordance with PLE's limited warranty. Testing and other quality control techniques are used to the extent PLE deems necessary to support this warranty. Except where mandated by specific contractual documents, testing of all parameters of each product is not necessarily performed.

PLE assumes no liability for application assistance or customer product design. Customers are responsible for their products and applications using PLE components. To minimize the risks associated with the customer products and applications, customers should provide adequate design and operating safeguards.

PLE products are not designed, intended, authorized or warranted to be suitable for use in life support applications, devices or systems or other critical applications that may involve potential risks of death, personal injury or severe property or environmental damage. Inclusion of PLE products in such applications is understood to be fully at the risk of the customer. Use of PLE products in such applications requires the written approval of an appropriate PLE officer. Questions concerning potential risk applications should be directed to PLE.

PLE does not warrant or represent that any license, either express or implied, is granted under any PLE patent right, copyright, artwork or other intellectual property right relating to any combination, machine or process which PLE product or services are used. Information published by PLE regarding third-party products or services does not constitute a license from PLE to use such products or services or a warranty or endorsement thereof. Use of such information may require a license from a third party under the patents or other intellectual property of the third party, or a license from PLE under the patents or other intellectual property of PLE.

Reproduction of information in PLE data sheets or web site is permissible only if the reproduction is without alteration and is accompanied by associated warranties, conditions, limitations and notices. Reproduction of this information with alteration is an unfair and deceptive business practice. PLE is not responsible or liable for such altered documents.

Resale of PLE products or services with statements different from or beyond the parameters stated by PLE for that product or service voids all express and implied warranties for the associated PLE product or service and is an unfair or deceptive business practice. PLE is not responsible for any such statements.

Contacting Pletronics Inc.

Pletronics Inc.
19013 36th Ave. West
Lynnwood, WA 98036-5761 USA

Tel: 425-776-1880
Fax: 425-776-2760
E-mail: ple-sales@pletronics.com
URL: www.pletronics.com

Copyright © 2007, 2010 Pletronics Inc.