

CRYSTAL OSCILLATOR PROGRAMMABLE

SG-8002DC / DB series

- Frequency range : 1 MHz to 125 MHz
- Supply voltage : 3.3 V or 5.0 V
- Function : Output enable(OE) or Standby(\overline{ST})
Pin compatible with full size and half size.
- Short mass production lead time by PLL technology.
- SG-Writer available to purchase.
Please contact EPSON TOYOCOM or local sales representative.

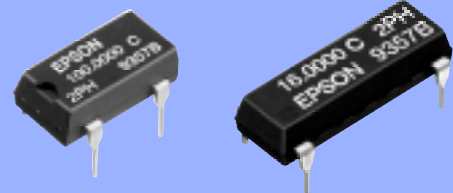

Actual size

SG-8002DC



SG-8002DB



Specifications (characteristics)

Item	Symbol	Specifications *2			Remarks	
		PT / ST	PH / SH	PC / SC		
Output frequency range	f_o	1 MHz to 125 MHz		—	Vcc=4.5 V to 5.5 V	
		—		1 MHz to 125 MHz	Vcc=3.0 V to 3.6 V	
		—		1 MHz to 66.7 MHz	Vcc=2.7 V to 3.6 V	
Supply voltage	Vcc	4.5 V to 5.5 V		2.7 V to 3.6 V		
Temperature range	Storage temperature	T_stg			-55 °C to +125 °C	Store as bare product after unpacking
	Operating temperature	T_use				
Frequency tolerance	$f_{tol}(osc)$	B: $\pm 50 \times 10^{-6}$, C: $\pm 100 \times 10^{-6}$			-20 °C to +70 °C	
		M: $\pm 100 \times 10^{-6}$			-40 °C to +85 °C *3	
Current consumption	I _{cc}	45 mA Max.		28 mA Max.	No load condition, Max. frequency	
Output disable current	I _{dis}	30 mA Max.		16 mA Max.	OE=GND(PT,PH,PC)	
Stand-by current	I _{std}	50 μ A Max.			\overline{ST} =GND(ST,SH,SC)	
Symmetry *1	SYM	—		40 % to 60 %	CMOS load:50%Vcc level, Max. load condition TTL load: 1.4V level, Max. load condition	
		40 % to 60 %		—		
High output voltage	V _{OH}	Vcc-0.4 V Min.			I _{OH} =-16 mA(PT,ST,PH,SH), -8 mA(PC,SC)	
Low output voltage	V _{OL}	0.4 V Max.			I _{OL} =16 mA(PT,ST,PH,SH), 8 mA(PC,SC)	
Output load condition (TTL) *1	L_TTL	5 TTL Max.		—	Max. frequency and Max. supply voltage	
Output load condition (CMOS) *1	L_CMOS	15 pF Max.		25 pF Max.	15 pF Max.	
Output enable / disable input voltage	V _{IH}	2.0 V Min.		70 % Vcc Min.	\overline{ST} , OE terminal	
	V _{IL}	0.8 V Max.		20 % Vcc Max.		
Output rise and fall time *1	t_r / t_f	—			3 ns Max.	CMOS load: 20 % Vcc to 80 % Vcc level
		4 ns Max.		—		TTL load: 0.4 V to 2.4 V level
Oscillation start up time	t _{osc}	10 ms Max.			Time at minimum supply voltage to be 0 s	
Frequency aging	f _{aging}	$\pm 5 \times 10^{-6}$ / year Max.			+25 °C, Vcc=5.0 V / 3.3 V (PC/SC) First year	

*1 Operating temperature (-40 °C to +85 °C), the available frequency, symmetry and output load conditions, please refer to "Outline specifications" page.

*2 PLL-PLL connection & Jitter specification, please refer to "Jitter specifications and characteristics chart" page.

*3 PT / ST and PH / SH for "M" tolerance will be available up to 55 MHz.

Checking possible by the Frequency Checking Program.

External dimensions

(Unit:mm)

● SG-8002DC

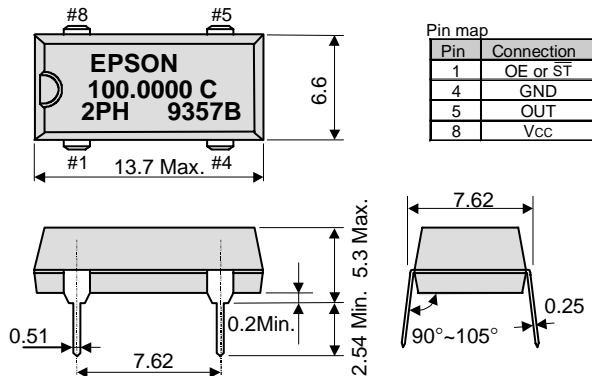

● SG-8002DB

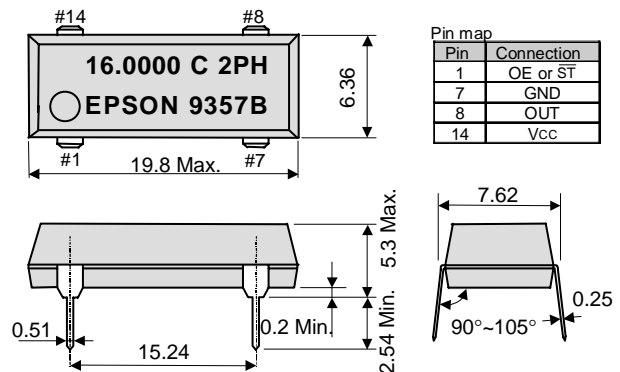

Note.

OE Pin (PT, PH, PC)

OE pin = "H" or "open" : Specified frequency output.

OE pin = "L" : Output is high impedance.

\overline{ST} pin (ST, SH, SC)

ST pin = "H" or "open" : Specified frequency output.

ST pin = "L" : Output is low level (weak pull - down), oscillation stops.



SG-8002 Series Outline of specifications

Item	Model	Current Consumption	Supply Voltage	Output load condition	Output rise time Output fall time	Symmetry	Function						
								PH	SH	PC	SC		
SG-8002LB (SOJ 4-pin)	PH	30 mA Max.	4.5 V to 5.5 V	15 pF	3.0 ns Max. (20 % V _{CC} to 80 % V _{CC} , L _{CMOS} =Max.)	40 % to 60 % (50 % V _{CC} , L _{CMOS} =15 pF, f ₀ ≤80 MHz/-40 °C to +85 °C)	OE						
							ST						
	PC	28 mA Max.	3.0 V to 3.6 V (2.7 V to 3.6 V)	15 pF	3.0 ns Max. (20 % V _{CC} to 80 % V _{CC} , L _{CMOS} =Max.)	45 % to 55 % (50 % V _{CC} , L _{CMOS} =15 pF, V _{CC} =3.0 V to 3.6 V, f ₀ ≤40 MHz) 40 % to 60 % (50 % V _{CC} , L _{CMOS} =15 pF, V _{CC} =3.0 V to 3.6 V, f ₀ ≤125 MHz) ↑ (50 % V _{CC} , L _{CMOS} =15 pF, V _{CC} =2.7 V to 3.6 V, f ₀ ≤66.7 MHz)	OE						
							ST						
SG-8002CA (SON)	PT	45 mA Max.	4.5 V to 5.5 V	5 TTL+15 pF (f ₀ ≤125 MHz/-20 °C to +70 °C) 25 pF (f ₀ ≤66.7 MHz/-20 °C to +70 °C) 5 TTL+15 pF (f ₀ ≤40 MHz/-40 °C to +85 °C) 15 pF (f ₀ ≤55 MHz/-40 °C to +85 °C)	2.0 ns Max. (0.8 V to 2.0 V, L _{CMOS} or L _{TTL} =Max.) 4.0 ns Max. (0.4 V to 2.4 V, L _{CMOS} or L _{TTL} =Max.)	45 % to 55 % (1.4 V, L _{TTL} =5 TTL+15 pF, f ₀ ≤66.7 MHz/-20 °C to +70 °C) ↑ (1.4 V, L _{TTL} =5 TTL+15 pF, f ₀ ≤40.0 MHz/-40 °C to +85 °C) 40 % to 60 % (1.4 V, L _{TTL} =5 TTL+15 pF, f ₀ ≤125 MHz/-20 °C to +70 °C) ↑ (1.4 V, L _{CMOS} =25 pF, f ₀ ≤66.7 MHz/-20 °C to +70 °C) ↑ (1.4 V, L _{CMOS} =15 pF, f ₀ ≤55.0 MHz/-40 °C to +85 °C)	OE						
							ST						
	PH	25 pF (f ₀ ≤125 MHz/-20 °C to +70 °C) 50 pF (f ₀ ≤66.7 MHz/-20 °C to +70 °C)	3.0 ns Max. (20 % V _{CC} to 80 % V _{CC} , L _{CMOS} ≤25) 4.0 ns Max. (20 % V _{CC} to 80 % V _{CC} , L _{CMOS} =Max.)	45 % to 55 % (50 % V _{CC} , L _{CMOS} =25 pF, f ₀ ≤40.0 MHz/-40 °C to +85 °C) ↑ (50 % V _{CC} , L _{CMOS} =25 pF, f ₀ ≤40.0 MHz/-40 °C to +85 °C) 40 % to 60 % (50 % V _{CC} , L _{CMOS} =50 pF, f ₀ ≤66.7 MHz/-20 °C to +70 °C) ↑ (50 % V _{CC} , L _{CMOS} =15 pF, f ₀ ≤55.0 MHz/-40 °C to +85 °C)	OE								
					SH								
SG-8002DB (DIP 14-pin)	PC	28 mA Max.	3.0 V to 3.6 V (2.7 V to 3.6 V)	15 pF (f ₀ ≤66.7 MHz/2.7 to 3.6 V) 15 pF (f ₀ ≤125 MHz/3.0 to 3.6 V) 30 pF (f ₀ ≤40 MHz/3.0 to 3.6 V)	3.0 ns Max. (20 % V _{CC} to 80 % V _{CC} , L _{CMOS} ≤15) 4.0 ns Max. (20 % V _{CC} to 80 % V _{CC} , L _{CMOS} =Max.)	45 % to 55 % (50 % V _{CC} , L _{CMOS} =30 pF, V _{CC} =3.0 V to 3.6 V, f ₀ ≤40 MHz) 40 % to 60 % (50 % V _{CC} , L _{CMOS} =15 pF, V _{CC} =3.0 V to 3.6 V, f ₀ ≤125 MHz) ↑ (50 % V _{CC} , L _{CMOS} =15 pF, V _{CC} =2.7 V to 3.6 V, f ₀ ≤66.7 MHz)	OE						
							SC						
SG-8002JC (SOJ 4-pin)	PT	45 mA Max.	4.5 V to 5.5 V	5TTL + 15 pF (f ₀ ≤90 MHz/-20 °C to +70 °C) 15 pF (f ₀ ≤125 MHz/-20 °C to +70 °C) 25 pF (f ₀ ≤66.7 MHz/-20 °C to +70 °C)	2.0 ns Max. (0.8 V to 2.0 V, L _{CMOS} or L _{TTL} =Max.) 4.0 ns Max. (0.4 V to 2.4 V, L _{CMOS} or L _{TTL} =Max.)	45 % to 55 % (1.4 V, L _{TTL} =5 TTL+15 pF, f ₀ ≤66.7 MHz/-20 °C to +70 °C) 40 % to 60 % (1.4 V, L _{TTL} =5 TTL+15 pF, f ₀ ≤90.0 MHz/-20 °C to +70 °C) ↑ (1.4 V, L _{CMOS} =25 pF, f ₀ ≤66.7 MHz/-20 °C to +70 °C) ↑ (1.4 V, L _{CMOS} =15 pF, f ₀ ≤125 MHz/-20 °C to +70 °C)	OE						
							ST						
							PH						
							SH						
	PC	28 mA Max.	3.0 V to 3.6 V (2.7 V to 3.6 V)	15 pF (f ₀ ≤66.7 MHz/2.7 to 3.6 V) 15 pF (f ₀ ≤125 MHz/3.0 to 3.6 V) 30 pF (f ₀ ≤40 MHz/3.0 to 3.6 V)	3.0 ns Max. (20 % V _{CC} to 80 % V _{CC} , L _{CMOS} ≤15) 4.0 ns Max. (20 % V _{CC} to 80 % V _{CC} , L _{CMOS} =Max.)	45 % to 55 % (50 % V _{CC} , L _{CMOS} =30 pF, V _{CC} =3.0 V to 3.6 V, f ₀ ≤40 MHz) 40 % to 60 % (50 % V _{CC} , L _{CMOS} =15 pF, V _{CC} =3.0 V to 3.6 V, f ₀ ≤125 MHz) ↑ (50 % V _{CC} , L _{CMOS} =15 pF, V _{CC} =2.7 V to 3.6 V, f ₀ ≤66.7 MHz)	OE						
							SC						
							SG-8002JF (SOJ 4-pin)	45 mA Max.	4.5 V to 5.5 V	15 pF (f ₀ ≤125 MHz/-20 °C to +70 °C) 25 pF (f ₀ ≤66.7 MHz/-20 °C to +70 °C) 5TTL + 15 pF (f ₀ ≤90 MHz/-20 °C to +70 °C) 15 pF (f ₀ ≤40 MHz/-40 °C to +85 °C)	2.0 ns Max. (0.8 V to 2.0 V, L _{CMOS} ≤25) 4.0 ns Max. (0.4 V to 2.4 V, L _{CMOS} or L _{TTL} =Max.)	45 % to 55 % (1.4 V, L _{TTL} =5 TTL+15 pF, f ₀ ≤66.7 MHz/-20 °C to +70 °C) 40 % to 60 % (1.4 V, L _{TTL} =5 TTL+15 pF, f ₀ ≤90 MHz/-20 °C to +70 °C) ↑ (1.4 V, L _{CMOS} =25 pF, f ₀ ≤66.7 MHz/-20 °C to +70 °C) ↑ (1.4 V, L _{CMOS} =15 pF, f ₀ ≤125 MHz/-20 °C to +70 °C) ↑ (1.4 V, L _{CMOS} =15 pF, f ₀ ≤40 MHz/-40 °C to +85 °C)	OE
													ST
PH													
SH													
PC	28 mA Max.	3.0 V to 3.6 V (2.7 V to 3.6 V)	15 pF (f ₀ ≤66.7 MHz/2.7 to 3.6 V) 15 pF (f ₀ ≤125 MHz/3.0 to 3.6 V) 30 pF (f ₀ ≤40 MHz/3.0 to 3.6 V)	3.0 ns Max. (20 % V _{CC} to 80 % V _{CC} , L _{CMOS} ≤15) 4.0 ns Max. (20 % V _{CC} to 80 % V _{CC} , L _{CMOS} =Max.)	45 % to 55 % (50 % V _{CC} , CL=30 pF, V _{CC} =3.0 V to 3.6 V, f ₀ ≤40 MHz) 40 % to 60 % (50 % V _{CC} , CL=15 pF, V _{CC} =3.0 V to 3.6 V, f ₀ ≤125 MHz) ↑ (50 % V _{CC} , CL=15 pF, V _{CC} =2.7 V to 3.6 V, f ₀ ≤66.7 MHz)	OE							
						SC							
SG-8002CE (SON)	PT	40 mA Max.	4.5 V to 5.5 V	5 TTL+15 pF (f ₀ ≤125 MHz/-20 °C to +70 °C) 5 TTL+15 pF (f ₀ ≤27 MHz/-40 °C to +85 °C)	2.0 ns Max. (0.8 V to 2.0 V, L _{TTL} =Max.) 4.0 ns Max. (0.4 V to 2.4 V, L _{TTL} =Max.)	45 % to 55 % (1.4 V, L _{TTL} =5 TTL+15 pF, f ₀ ≤66.7 MHz/-20 °C to +70 °C) ↑ (1.4 V, L _{TTL} =5 TTL+15 pF, f ₀ ≤27.0 MHz/-40 °C to +85 °C) 40 % to 60 % (1.4 V, L _{TTL} =5 TTL+15 pF, f ₀ ≤125 MHz/-20 °C to +70 °C)	OE						
							ST						
							PH						
							SH						
	PC	28 mA Max.	3.0 V to 3.6 V (2.7 V to 3.6 V)	15 pF (f ₀ ≤66.7 MHz/2.7 to 3.6 V) 15 pF (f ₀ ≤125 MHz/3.0 to 3.6 V)	3.0 ns Max. (20 % V _{CC} to 80 % V _{CC} , L _{CMOS} =Max.)	45 % to 55 % (50 % V _{CC} , L _{CMOS} =25 pF, f ₀ ≤66.7 MHz/-20 °C to +70 °C) ↑ (50 % V _{CC} , L _{CMOS} =25 pF, f ₀ ≤27.0 MHz/-40 °C to +85 °C) 40 % to 60 % (50 % V _{CC} , L _{CMOS} =15 pF, f ₀ ≤125 MHz/-20 °C to +70 °C)	OE						
							SC						

▶ TABLE OF FREQUENCY RANGE

Model		Supply voltage	Frequency tolerance Operating Temperature	Frequency			
				1 MHz	50 MHz	100 MHz	125 MHz
SG-8002CE	PT/ ST PH/ SH	4.5 V to 5.5 V	B, C	1.0 MHz	████████████████████	████████████████████	125 MHz
	PC/ SC	3.0 V to 3.6 V (2.7 V to 3.6 V)	M	1.0 MHz	████████████████████	27 MHz	████████████████████
			B, C, M	1.0 MHz	████████████████████	████████████████████	125 MHz
				*2.7 V to 3.6 V : 1.0 MHz to 66.7 MHz			
SG-8002LB	PH/ SH	5.0 V±0.5 V	B, C	1.0 MHz	████████████████████	████████████████████	80 MHz
			M, L	1.0 MHz	████████████████████	27 MHz	████████████████████
	PC/ SC	3.3 V±0.3 V	B, C, M, L	1.0 MHz	████████████████████	████████████████████	125 MHz
				*2.7 V to 3.6 V : 1.0 MHz to 66.7 MHz			
SG-8002JF	PT/ ST PH/ SH	4.5 V to 5.5 V	B, C	1.0 MHz	████████████████████	████████████████████	125 MHz
			M	1.0 MHz	████████████████████	40 MHz	████████████████████
	PC SC	3.0 V to 3.6 V (2.7 V to 3.6 V)	B, C, M	1.0 MHz	████████████████████	████████████████████	125 MHz
				*2.7 V to 3.6 V : 1.0 MHz to 66.7 MHz			
SG-8002CA SG-8002JA SG-8002DB SG-8002DC	PT/ ST PH/ SH	4.5 V to 5.5 V	B, C	1.0 MHz	████████████████████	████████████████████	125 MHz
			M	1.0 MHz	████████████████████	55 MHz	████████████████████
	PC/ SC	3.0 V to 3.6 V (2.7 V to 3.6 V)	B, C, M	1.0 MHz	████████████████████	████████████████████	125 MHz
				*2.7 V to 3.6 V : 1.0 MHz to 66.7 MHz			
SG-8002JC	PT/ ST PH/ SH	4.5 V to 5.5 V	B	1.0 MHz	████████████████████	████████████████████	125 MHz
			C	1.0 MHz	████████████████████	████████████████████	125 MHz
	PC/ SC	3.0 V to 3.6 V (2.7 V to 3.6 V)	B C	1.0 MHz	████████████████████	████████████████████	125 MHz
				*2.7 V to 3.6 V : 1.0 MHz to 66.7 MHz			

Frequency tolerance : B:±50×10⁻⁶(-20 °C to +70 °C), C:±100×10⁻⁶(-20 °C to +70 °C), M:±100×10⁻⁶(-40 °C to +85 °C), L:±50×10⁻⁶(-40 °C to +85 °C)



SG / HG-8002 series_ Jitter specifications and characteristics chart

■ PLL-PLL connection

Because we use a PLL technology, there are a few cases that the jitter value will increase when SG-8002 is connected to another PLL-oscillator.

In our experience, we are unable to recommend these products for the applications such as telecom carrier use or analog video clock use. Please be careful checking in advance for these application (Jitter specification is Max.250 ps/CL=15 pF)

■ Remarks on noise management for power supply line

We do not recommend inserting filters or other devices in the power supply line as the counter measure of EMI noise reduction.

This device insertion might cause high-frequency impedance high in the power supply line and it affects oscillator stable drive.

When this measure is required, please evaluate circuitry and device behavior in the circuit and verify that it will not affect oscillation.

Start up time (0 % Vcc to 90 % Vcc) of power source should be more than 150 μs.

■ Jitter Specifications

Model	Supply Voltage	Jitter Item	Specifications	Remarks
PT / PH ST / SH	5.0 V ±0.5 V	Cycle to cycle	150 ps Max.	33 MHz ≤ f ₀ ≤ 125 MHz, L_CMOS=15 pF
			200 ps Max.	1.0 MHz ≤ f ₀ < 33 MHz, L_CMOS=15 pF
		Peak to peak	200 ps Max.	33 MHz ≤ f ₀ ≤ 125 MHz, L_CMOS=15 pF
			250 ps Max.	1.0 MHz ≤ f ₀ < 33 MHz, L_CMOS=15 pF
SC / PC	3.3 V ±0.3 V	Cycle to cycle	200 ps Max.	1.0 MHz ≤ f ₀ ≤ 125 MHz, L_CMOS=15 pF
		Peak to peak	250 ps Max.	1.0 MHz ≤ f ₀ ≤ 125 MHz, L_CMOS=15 pF

■ SG-8002 series Characteristics chart

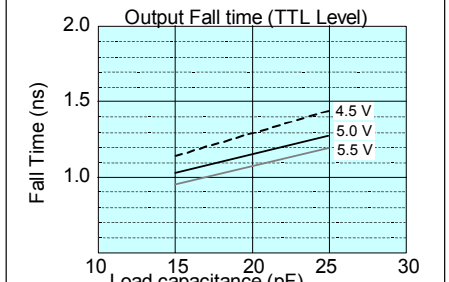
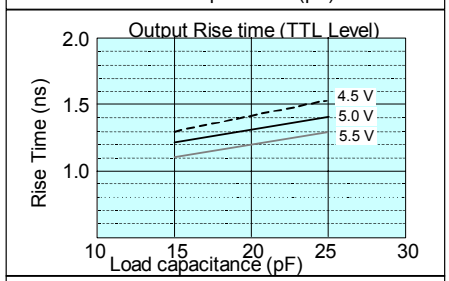
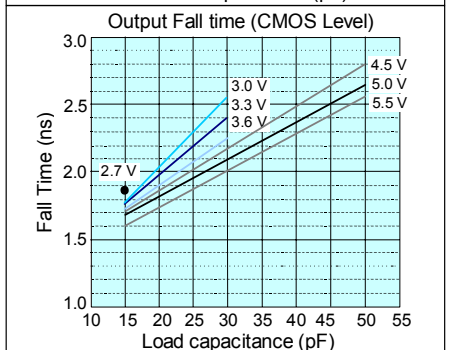
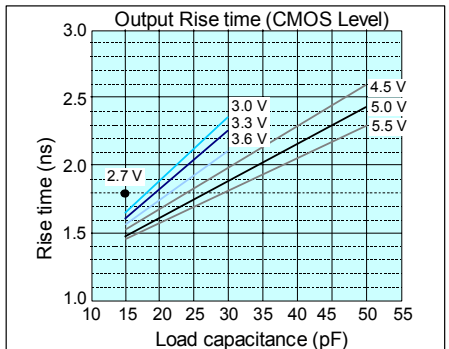
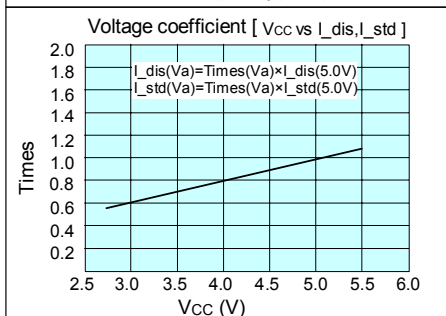
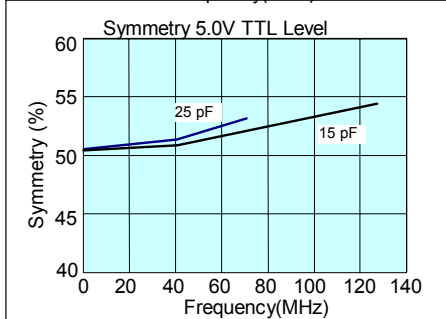
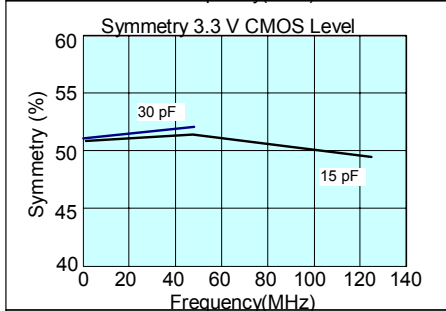
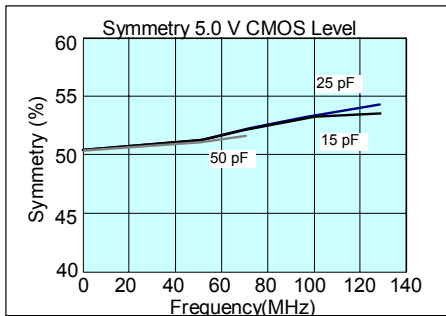
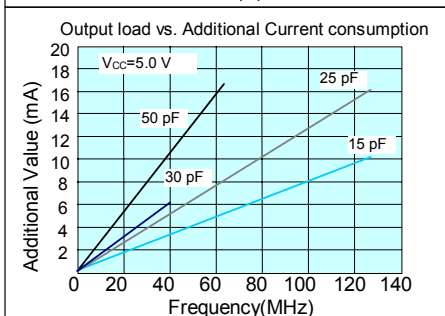
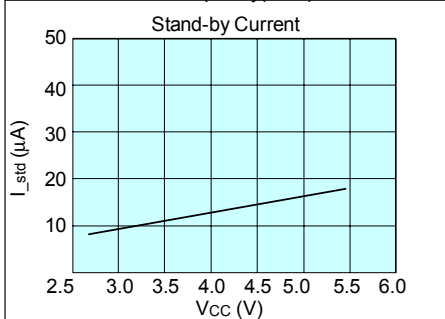
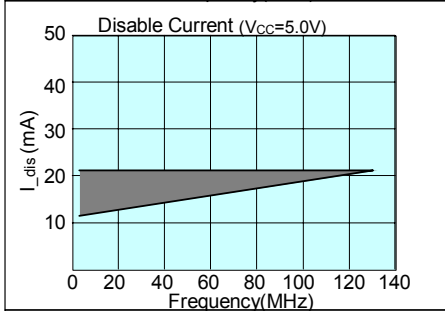
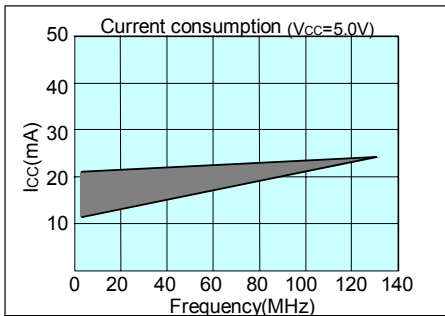

“Quartz + MEMS” EPSON TOYOCOM

In order to meet customer needs in a rapidly advancing digital, broadband and ubiquitous society, we are committed to offering products that are one step ahead of the market and a rank above the rest in quality. To achieve our goals, we follow a “3D (three device) strategy” designed to drive both horizontal and vertical growth. We will to grow our three device categories of “Timing Devices”, “Sensing Devices” and “Optical Devices”, and expand vertical growth through a combination of products from these categories.

A Quartz MEMS is any high added value quartz device that exploits the characteristics of quartz crystal material but that is produced using MEMS (micro-electro-mechanical system) processing technology.

Market needs are advancing faster than previously imagined toward smaller, more stable crystal products, but we will stay ahead of the curve by rolling out products that exceed market speed and quality requirements. We want to further accelerate the 3D strategy by QMEMS.

Quartz devices have become crucial in the network environment where products are increasingly intended for broadband, ubiquitous applications and where various types of terminals can transfer information almost immediately via LAN and WAN on a global scale. Epson Toyocom Corporation addresses every single aspect within a network environment. The new corporation offers “Digital Convergence” solutions to problems arising with products for consumer use, such as, core network systems and automotive systems.

PROMOTION OF ENVIRONMENTAL MANAGEMENT SYSTEM CONFORMING TO INTERNATIONAL STANDARDS

At Epson Toyocom, all environmental initiatives operate under the Plan-Do-Check-Action(PDCA) cycle designed to achieve continuous improvements. The environmental management system (EMS) operates under the ISO 14001 environmental management standard.

All of our major manufacturing and non-manufacturing sites, in Japan and overseas, completed the acquisition of ISO 14001 certification. In the future, new group companies will be expected to acquire the certification around the third year of operations.

ISO 14000 is an international standard for environmental management that was established by the International Standards Organization in 1996 against the background of growing concern regarding global warming, destruction of the ozone layer, and global deforestation.

WORKING FOR HIGH QUALITY

In order provide high quality and reliable products and services than meet customer needs, Epson Toyocom made early efforts towards obtaining ISO9000 series certification and has acquired ISO9001 for all business establishments in Japan and abroad. We have also acquired ISO/TS 16949 certification that is requested strongly by major automotive manufacturers as standard.

QS-9000 is an enhanced standard for quality assurance systems formulated by leading U.S.automobile manufacturers based on the international ISO 9000 series.

ISO/TS 16949 is a global standard based on QS-9000, a severe standard corresponding to the requirements from the automobile industry.

Notice

- This material is subject to change without notice.
- Any part of this material may not be reproduced or duplicated in any form or any means without the written permission of Epson Toyocom.
- The information, applied circuitry, programming, usage, etc., written in this material is intended for reference only. Epson Toyocom does not assume any liability for the occurrence of infringing on any patent or copyright of a third party. This material does not authorize the licensing on for any patent or intellectual copyrights.
- Any product described in this material may contain technology or the subject relating to strategic products under the control of the Foreign Exchange and Foreign Trade Law of Japan and may require an export license from the Ministry of International Trade and Industry or other approval from another government agency.
- You are requested not to use the products (and any technical information furnished, if any) for the development and/or manufacture of weapon of mass destruction or for other military purposes. You are also requested that you would not make the products available to any third party who may use the products for such prohibited purposes.
- These products are intended for general use in electronic equipment. When using them in specific applications that require extremely high reliability, such as the applications stated below, you must obtain permission from Epson Toyocom in advance.
/ Space equipment (artificial satellites, rockets, etc.) / Transportation vehicles and related (automobiles, aircraft, trains, vessels, etc.)
/ Medical instruments to sustain life / Submarine transmitters / Power stations and related / Fire work equipment and security equipment
/ traffic control equipment / and others requiring equivalent reliability.
- In this new crystal master for Epson Toyocom, product codes and markings will remain as previously identified prior to the merger.
Due to the on-going strategy of gradual unification of part numbers, please review product codes and markings, as they will change during the course of the coming months.
We apologize for the inconvenience, but we will eventually have a unified part numbering system for Epson Toyocom that will be user friendly.