

# SPECIFICATION

Customer : QUARTZ-1

受 控

Applied To :



Product Name : Ultra Sonic Transducer

Model Name : PCT-4000-9018

Drawing No. : OEM9018

Signature of Approval

Signature of KEPO

Approved by	Checked by	Issued by	Date
			

宁波凯普电子有限公司



Ningbo Kepo Electronics Co.,Ltd.

宁波东钱湖镇东钱湖工业区宝源路 25 号

TEL:+86-574-88370330 FAX:+86-574-88370329

No.25 Baoyuan road Dongqian Lake, Industry Area, Dongqian town,Ningbo City,  
China(Post Code:315121)

[Sales@chinaacoustic.com](mailto:Sales@chinaacoustic.com)

[www.chinaacoustic.com](http://www.chinaacoustic.com)

Specification for Ultra Sonic Transducer	Page	2/9
	Revision No.	1.0
	Drawing No.	OEM9018
Model No. : PCT-4000-9018		

## CONTENTS

1. Scope  
范围
2. General  
概要
3. Maximum Rating  
额定极限条件
4. Electrical Characteristics  
电性能
5. Measuring Method  
测试方法
6. Physical Characteristics  
机械性能
7. Environmental Characteristics  
环境性能
8. Dimensions  
尺寸
9. Packaging Standard  
包装标准
10. Cautions  
警告
11. Cautions for Use  
注意事项
12. Revision  
履历表

Specification for Ultra Sonic Transducer	Page	3/9
	Revision No.	1.0
	Drawing No.	OEM9018

Model No. : PCT-4000-9018

## 1. 范围 Scope

This product specification is applied to the piezoelectric sounder in alarm systems. Please contact us when using this product for any other applications than described in the above.

本规格书适用于压电式蜂鸣器，通常它用在系统中做报警或提示的蜂鸣器用，如果将该产品用于其它领域，请与我们联系。

## 2. 概要 General

2.1 Out-Diameter : Ø41mm

外径: Ø41 mm

2.2 Height : 12mm

高度: 12 mm

2.3 Weight : 6 gr.

重量: 6 克

2.4 Case Material/Color : PC/Black

壳体材质/颜色: PC/黑

## 3. 额定极限条件 Maximum Rating

	项目 Item	规格 Specification
3.1	最高输入电压 Maximum input Voltage	30Vp-p Square Wave /max.
3.2	工作温度范围 Operating Temperature Range	-20 ~ +60°C
3.3	储存温度范围 Storage Temperature Range	-30 ~ +70°C

## 4. 电性能 Electrical Characteristics

	项目 Item	规格 Specification
4.1	声压 Sound Pressure Level	90dB/2.83Vrms/3.7-7KHz/50cm 90dB/2.83Vrms/20-25KHz/50cm
4.2	容量 Capacitance at 100Hz	130000pF ± 30%

测试条件参见下项

Refer to next item for measuring method.

Specification for Ultra Sonic Transducer Model No. : PCT-4000-9018	Page	4/9
	Revision No.	1.0
	Drawing No.	OEM9018

## 5. 测试方法 Measuring Method

### 5.1 声压测试线路 S.P.L. Measuring Circuit

输入信号:2.83Vrms,2.5-60KHz, 正弦波  
Input Signal:2.83Vrms,2.5-60KHz,Sine wave

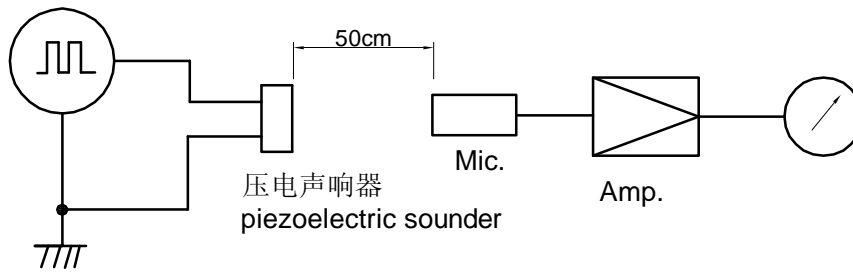

MIC : ND10 普通声级计或等同品  
MIC : ND10 Sound Meter or equivalent

S.G. : DF1212 BL 音频扫频信号发生器或等同品  
S.G. : DF1212 BL Oscillater or equivalent

### 5.2 测试环境 Measuring Condition

温度 $+25\pm 3^{\circ}\text{C}$ , 湿度 $60\pm 10\%\text{R.H.}$ .标准测试状态,在没有疑问的场合,可以在温度 $+5\sim +35^{\circ}\text{C}$ ,湿度 $45\sim 85\%\text{R.H.}$ 的范围内测试.

Part shall be measured under a condition (Temperature : $+5$  to  $+35^{\circ}\text{C}$ , Humidity :45 to 85%R.H.)unless the standard condition (Temperature : $+25 \pm 3^{\circ}\text{C}$ , Humidity : $60 \pm 10\%$ R.H.) is regulated measure.

### 5.3 曲线图

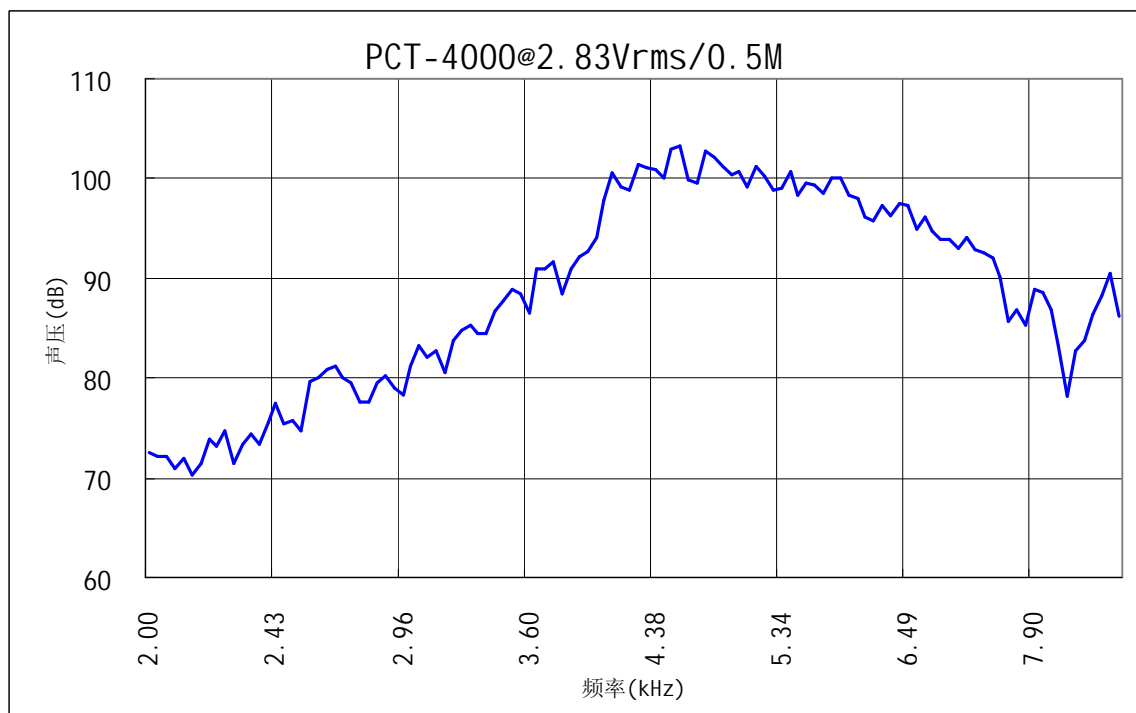

Specification for Ultra Sonic Transducer	Page	5/9
	Revision No.	1.0
	Drawing No.	OEM9018
Model No. : PCT-4000-9018		

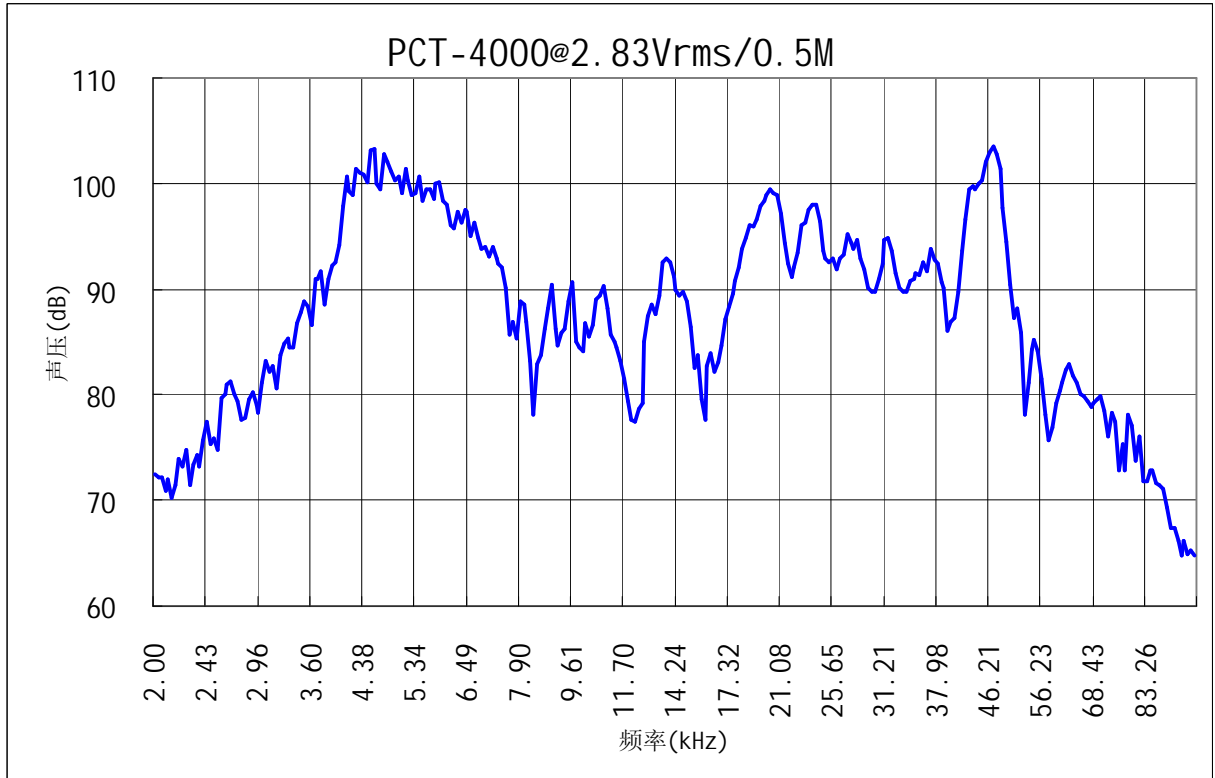

## 6. 机械性能 Physical Characteristics

	实验项目 Item	实验条件 Test Condition	实验后规格 Specification
6.1	耐冲击性 Shock	<p>峰值加速度 <math>490\text{m/s}^2</math>, 半正弦波, XYZ 三个方向各3次冲击实验后, 测试扬声器.</p> <p>Sounder shall be measured after being applied shock(<math>490\text{m/s}^2</math>) for each three mutually perpendicular directions to each of 3 times by half sine wave.</p>	符合表1的要求  The measured value shall meet Table 1.
6.2	耐振动性 Vibration Resistant	<p>振动频率 10~55 Hz, 1.5mm 全振幅, XYZ 三个方向各2小时试验后, 测试扬声器.</p> <p>Sounder shall be measured after being applied vibration of amplitude of 1.5mm with 10 to 55Hz band of vibration frequency to each of 3 perpendicular directions for 2 hours.</p>	

Specification for Ultra Sonic Transducer	Page	6/9
	Revision No.	1.0
	Drawing No.	OEM9018

Model No. : PCT-4000-9018

## 7. 环境性能 Environmental Characteristics

	实验项目 Item	实验条件 Test Condition	
7.1	高温放置 Dry Heat Test (Storage)	<p>放置于温度<math>+70 \pm 2^\circ\text{C}</math>的烘箱内96小时, 然后取出, 在常温下放置4小时后, 测试声响器。</p> <p>After being placed in a chamber with <math>+70 \pm 2^\circ\text{C}</math> for 96 hours and then being placed in natural condition for 4 hours, sounder shall be measured.</p>	符合表1的要求  The measured value shall meet Table 1.
7.2	低温放置 Cold Test (Storage)	<p>放置于温度<math>-30 \pm 2^\circ\text{C}</math>的制冷箱内96小时, 然后取出, 在常温下放置4小时后, 测试声响器。</p> <p>After being placed in a chamber with <math>-30 \pm 2^\circ\text{C}</math> for 96 hours and then being placed in natural condition for 4 hours, sounder shall be measured.</p>	
7.3	耐湿性 Humidity	<p>放置于 90%~95% R.H., 温度<math>+40 \pm 2^\circ\text{C}</math>的环境试验箱内96小时, 然后取出, 在常温下放置4小时后, 测试声响器。</p> <p>After being placed in a chamber with 90 to 95%R.H. at <math>+40 \pm 2^\circ\text{C}</math> for 96 hours and then being placed in natural condition for 4 hours, sounder shall be measured.</p>	
7.4	温度循环 Temperature Cycle	<p>先放置于温度<math>-30 \pm 2^\circ\text{C}</math>的制冷箱内30分钟, 然后放置于室温(<math>+20^\circ\text{C}</math>)15分钟后, 放置于<math>+70 \pm 2^\circ\text{C}</math>的烘箱内30分钟, 再放置于室温(<math>+20^\circ\text{C}</math>)15分钟。</p> <p>经过以上循环5次, 在常温下放置4小时后, 测试声响器。</p> <p>After being placed in a chamber at <math>-30 \pm 2^\circ\text{C}</math> for 30 minutes, sounder shall be placed at room temperature(<math>+20^\circ\text{C}</math>). After 15 minutes at this temperature, sounder shall be placed in a chamber at <math>+70 \pm 2^\circ\text{C}</math>. After 30 minutes at this temperature, sounder shall be returned to room temperature (<math>+20^\circ\text{C}</math>) for 15 minutes.</p> <p>After 5 above cycles, sounder shall be measured after being placed in natural condition for 4 hours.</p>	

表 1 Table 1

项 目 Item	试验后变化量 Specification after test
声压级 Sound Pressure Level	初始值 $\pm 10\text{dB}$ Initial Value $\pm 10\text{dB}$

Specification for Ultra Sonic Transducer	Page	7/9
	Revision No.	1.0
Model No. : PCT-4000-9018	Drawing No.	OEM9018

### 8. Dimensions

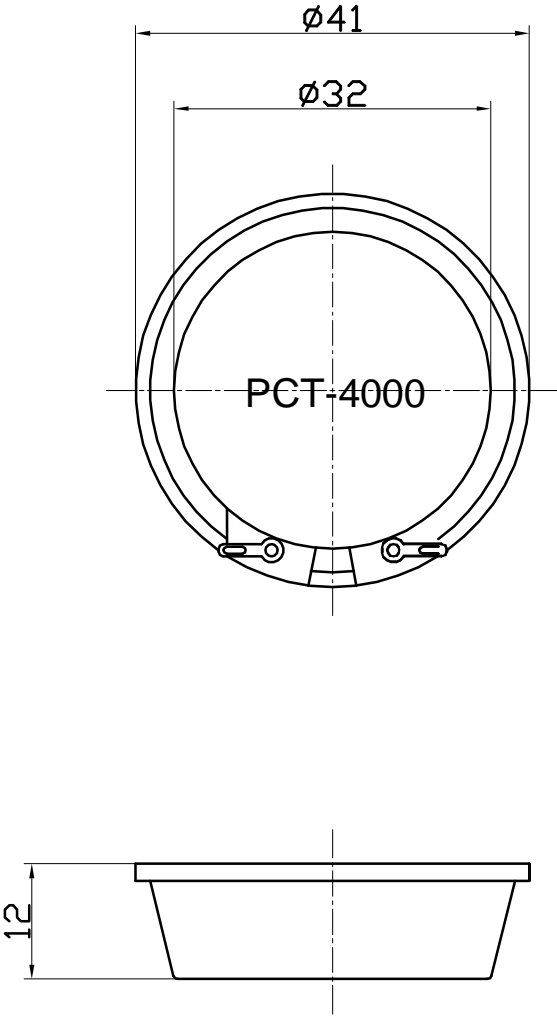

FIRST ANGLE PROJECTION

UNIT : mm  
Tolerance :  $\pm 0.5$

Specification for Ultra Sonic Transducer	Page	8/9
	Revision No.	1.0
	Drawing No.	OEM9018
Model No. :	PCT-4000-9018	

## 9. 包装标准 Packaging Standard

产品的外包装是纸箱, 它应该清楚的标明型号, 数量, 出厂检验批号.  
在运输及储存的过程中, 产品必须不会受到机械损伤.

Each minimum package unit of products shall be in a carton box and it shall be clearly marked with Part Number, quantity and outgoing inspection number.

There shall be no mechanical damage on products during transportation and/or in storage.

## 10. 警告 Cautions

如果产品使用于下列高可靠性的装置时, 请与我们联系, 以免对人的生命, 财产和身体造成损害.

Please contact us before using our products for the undermentioned applications requiring especially high reliability in order to prevent defects which might directly cause damage to other party's life, body or property (listed below).

- (1) Aircraft equipment 飞行设备
- (2) Aerospace equipment 航天设备
- (3) Undersea equipment 潜水设备
- (4) Medical equipment 医疗设备
- (5) Transportation equipment (automobiles, trains, ships) 交通设施
- (6) Traffic signal equipment 交通信号设备
- (7) Disaster prevention/crime prevention equipment 防灾害/防犯罪设备
- (8) Data-processing equipment 数据处理设备
- (9) Applications of similar complexity or reliability requirements comparable to the applications listed in the above 以及与上述相类似或可靠性要求更高的设备

## 11. 注意事项 Cautions for Use

11.1 如果产品所承受的机械应力超过规定的值, 元件可能被破坏.

The component may be damaged if mechanical stress over this specification is applied.

11.2 请注意保护工作电路不会因失误, 跌落和温度变化而产生浪涌电压.

Please pay attention to protect operating circuit from surge voltage provided by something of force such as failing, shock and temperature changing.

11.3 请注意永远不要给压电声响器施加直流电压.

Please pay attention never to be applied DC voltage to piezo sounder.

11.4 该声响器不适合洗涤, 因为它不密封.

Washing of the component is not acceptable. Because it is not sealed.

11.5 在使用烙铁的情况下, 应注意烙铁头的温度应该保持在 +350℃ 以下, 并且焊接时间控制在 3 秒内.

In case of using solder iron for soldering, the top of soldering iron's temperature should be kept less than +350 °C. Moreover the soldering time should be also kept with in 3seconds.



Specification for Ultra Sonic Transducer		Page	9/9
Model No. : PCT-4000-9018		Revision No.	1.0
		Drawing No.	OEM9018

## 12. Revision

Rev. No.	DATE	PAGE	DESCRIPTION	SIGN
1.0	2012.07.02	/	primary	