

MTW16-X Series

FEATURES

Sealed with **built-in**
oscillating circuit for
wave soldering and washing

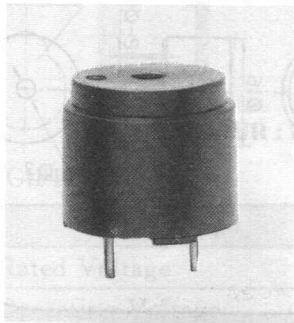

COLOUR : BLACK

WASHABLE

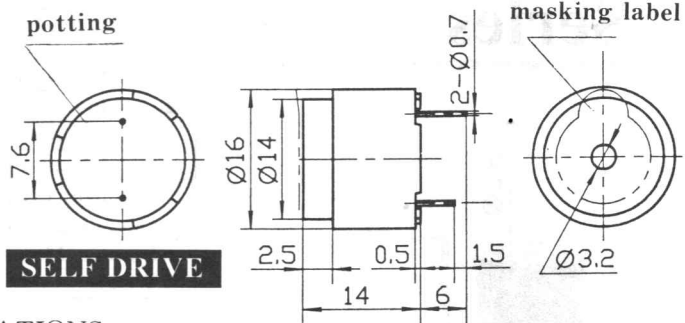

SPECIFICATIONS

Type	MTW1601X	MTW1606X	MTW1612X
Rated Voltage (V)	1.5	6	12
Operating Voltage (V)	1.3~2	4~8	8~15
△Rated Current (mA)	≤20	≤30	
△Sound Output at 10cm (dB)	≥75	≥85	
△Resonant Frequency (Hz)	2300±400	2300±300	
▲Response Time (ms)	≤50		
Operating Temperature (°C)	-10~+50	-25~+80	
Storage Temperature (°C)	-15~+60	-30~+80	
Weight (g)	7		

△ Value applying rated voltage (DC)

▲ Value applying (Min. operational DC voltage)

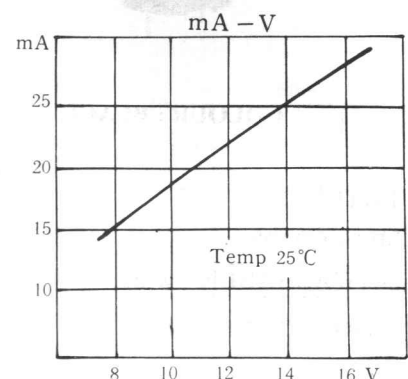
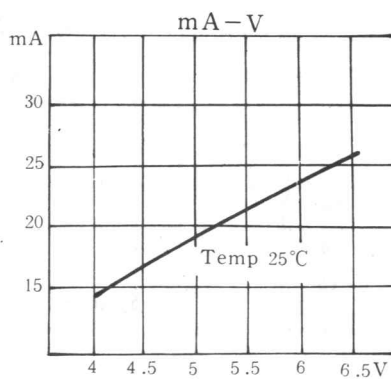
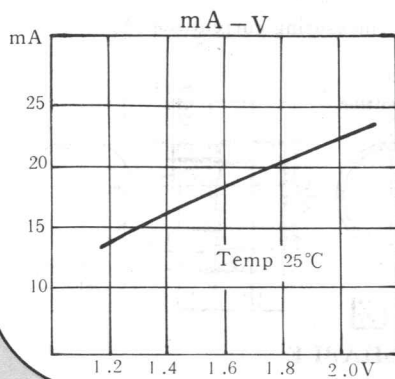
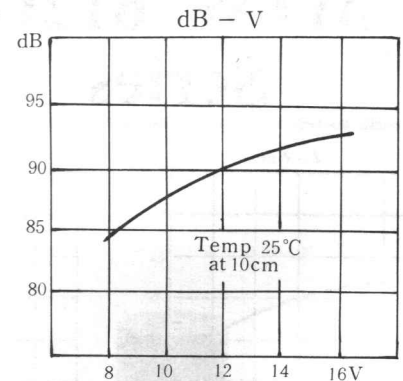
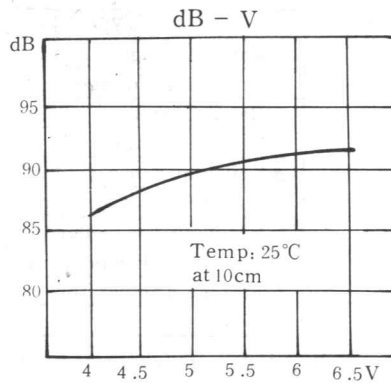
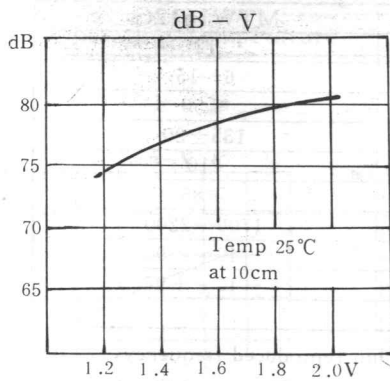

MT : MAGNETIC TRANSDUCER

W : WAVE SOLDERING / WASHABLE