

Ultrasonic Transducer Specification

超 声 波 换 能 片

1.品名(Name): 压电陶瓷圆片(Piezo electric Disc)

2.产品型号 (PN): JYY-φ10×1.0-P4

3.材料 (Ceramic Material): PZT-41

4.性能参数(Electrical specification):

项目 Item	单位 Unit	标 准 Standard	测试条件(Test condition): T=22°C 极化后 10 天测试
径向谐振频率 (Fs) Radial resonant frequency (Fs)	KHz	230±20	压电阻抗分析仪 impedance analyzer
厚向谐振频率 (Ft) Thickness resonant frequency (Ft)	Mhz	2.0±0.2	压电阻抗分析仪 impedance analyzer
静电容量 (C0) Static capacitance (C0)	pF	770±15%	数字电桥 At 1000Hz/1V Digital Electric Bridge At 1000Hz/1V
介质损耗 (tgδ) dielectrin loss (tgδ)	%	≤0.3	数字电桥 At 1000Hz/1V Digital Electric Bridge At 1000Hz/1V
机电耦合系数(Kp) Electrical-mechanical coupling coefficient (Kp)		≥0.52	压电阻抗分析仪 impedance analyzer

5.外观尺寸(Appearance and dimensions):

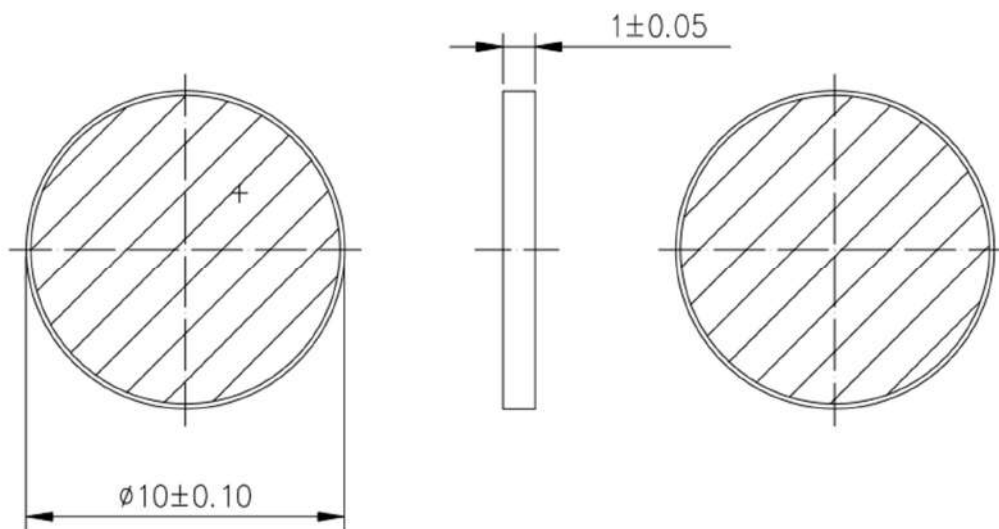

Remark: This specification is subject to change without prior notice.

6.包装(Package):

Qty/Carton	Carton Size (cm)	G.W.(Kg)	N.W.(Kg)
18000pcs	28*22*30cm	11.20	10.00