

Ultrasonic Transducer Specification

超声波压电换能片规格书

1. 产品型号 (Product Model): JRP4-Ø35XØ15X5
2. 尺寸 (Appearance Size): Ø35XØ15X5mm
3. 电性能参数 (Electrical specification):

序号 No.	项目 Item	标准值 Standard Value
1	谐振频率(Fr) Resonant frequency(Khz)	43±2.0
2	静态电容 CT Static Capacitance (pF)	1800±10%
3	压电常数 d33 Piezoelectric charge Constant(pc/N)	240±15%
4	介电损耗 tgv (%) Dielectric Loss tgv (%)	≤0.3%
5	机械品质因素(Qm) Mechanical quality factors	1000
6	压电片外径 D1 (mm) Piezoelectric External Diameter D1(mm)	35±0.10
7	压电片内径 D2 (mm) Piezoelectric internal Diameter D2(mm)	15±0.10
8	压电片厚度 T (mm) Piezoelectric Disc Thickness T(mm)	5±0.05

4. 尺寸和外观 (Dimension and Appearance) , Unit(mm)

1) 外观尺寸(Dimensions)

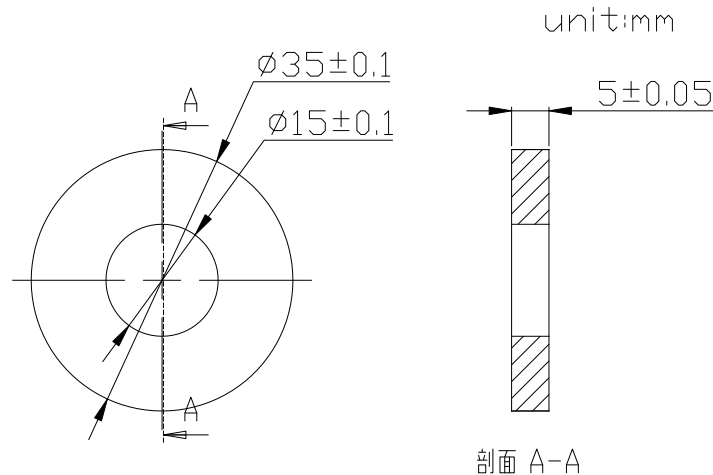

2) 外观要求 (Appearance Requirements)

- ① 电极面上无明显显露、磨损和划伤

There is no obvious ceramic revealed, abrasion or scratches on the electrode surface.

- ② 无缺瓷、崩边和裂纹等损伤

The ceramic disc looks complete without crack

5. 标准包装 (Package)

Qty/Carton	Carton Size	G.W.	N.W.
400pcs	30X29X21CM	13.4kg	11.28kg