

SMD QUARTZ CRYSTAL RESONATOR
石英晶体谐振器

4 Pad Version 3.2x2.5 mm

- ± 10 ppm type available
- Excellent Reliability Performance
- EMI shielding possible by grounded lid
- Reflow soldering temperature: 260 max
- Ceramic Seam Weld package

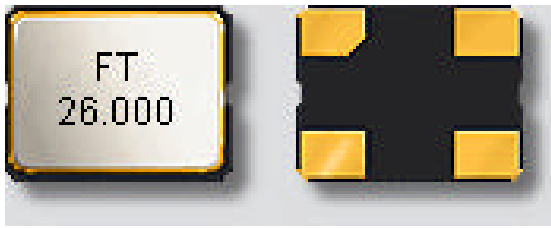

RoHS compliant

PARAMETERS
技术参数

PARAMETERS	参数	SPECIFICATION 规格
Frequency Range	频率范围	12 ~ 50MHz
Operation Mode	振动模式	Fundamental
Loading Capacitance	负载电容	9pF Std. 8 to 32pF Series available
Drive Level	激励电平	10 μ W (300 μ W Max)
Frequency Tolerance	频率偏差	± 10ppm ~ ±30ppm (at 25)
Equivalent Resistance	谐振电阻	100 Max
Frequency Stability	频率稳定性	±5ppm ~ ±50ppm
Operating Temp. Range:	工作温度范围	-10 ~ +60 to -40 ~ +85
Storage Temp. Range:	储存温度范围	-40 ~ +85

All specification subject change without notice. 规格变化，恕不另行通知。

FREQUENCY STABILITY VS. TEMPERATURE 频率温度特性
ESR (SERIES RESISTANCE RS)

Operation Temperature Range	Frequency Stability					
	±5ppm	±10ppm	±15ppm	±20ppm	±30ppm	±50ppm
-10 ~ +60						
-20 ~ +70						
-40 ~ +85						

Frequency	Vib. Mode	ESR
12-15.999MHz	AT CUT/FUND.	1000(MAX)
16-18.999MHz	AT CUT/FUND.	800(MAX)
19-26.999MHz	AT CUT/FUND.	600(MAX)
27-50.000MHz	AT CUT/FUND.	400(MAX)

standard available

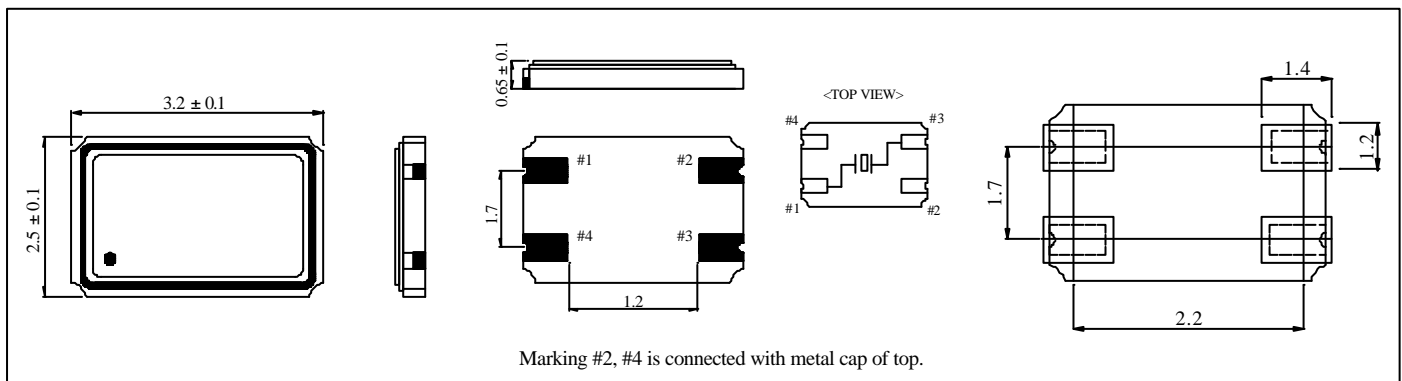
DIMENSIONS & LAND PATTERN LAYOUT (Unit: mm) 外形尺寸

PART NUMBER GUIDE 部件号示例

e.g. FTX26.000M9SM3S (*SM3S=3.2 x 2.5 SMD S-SEAM TYPE)

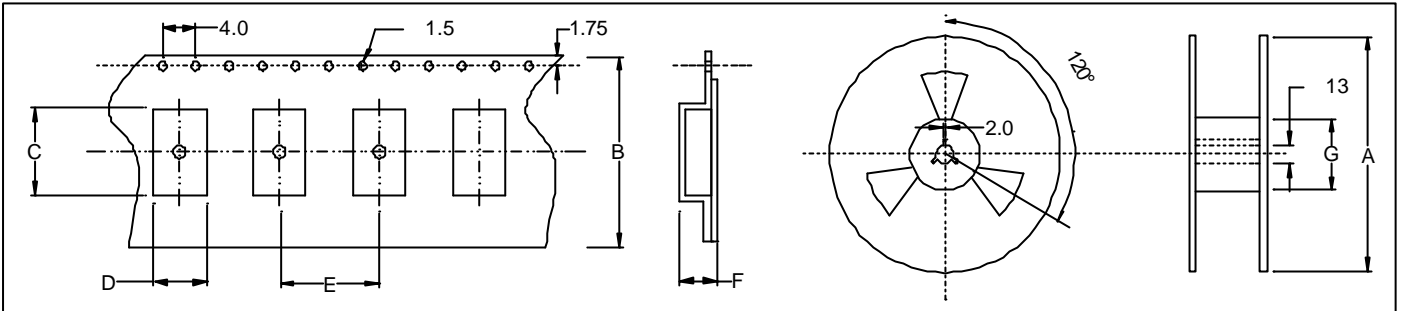
FT	Quartz Crystal Resonator 石英晶体谐振器	Frequency 频率	Load Capacitance 负载电容	Package 盒型
	X	26.000MHz	9	SM3S

TAPING SPECIFICATION (Unit: mm) 编带规格

	A	B	C	D	E	F	G
SMD3225	178 ± 2.0	12.0 ± 0.3	3.55 ± 0.10	2.80 ± 0.10	4.0 ± 0.1	0.85 ± 0.10	60.5 ± 1.0
3000 pcs per reel							

REFLOW SOLDERING PROFILE 回流焊特性
