

MODEL: CN2845-68LB P8



ELECTRICAL SPECIFICATION:

Item	Unit	Standard
Resonant Frequency	KHz	28 ± 0.5
Resonant Impedance	Ω	25 ↓
Capacitance	PF	5500 ± 10%
Diameter	MM	68
Total height	MM	68
Insulation Impedance	MΩ	10000 ↑
Rated Power	W	100

"P4" - Black piezoelectric ceramic, which transmits better
 "P8" - Yellow piezoelectric ceramic, which has better heat stability

Backnail: welded to substrate by Argon Arc Welding Technology.

Sticker: welded to substrate by Energy Storage Type Studs Gun Welding Technology.

Please tell us what kind of ceramic and screw you need.

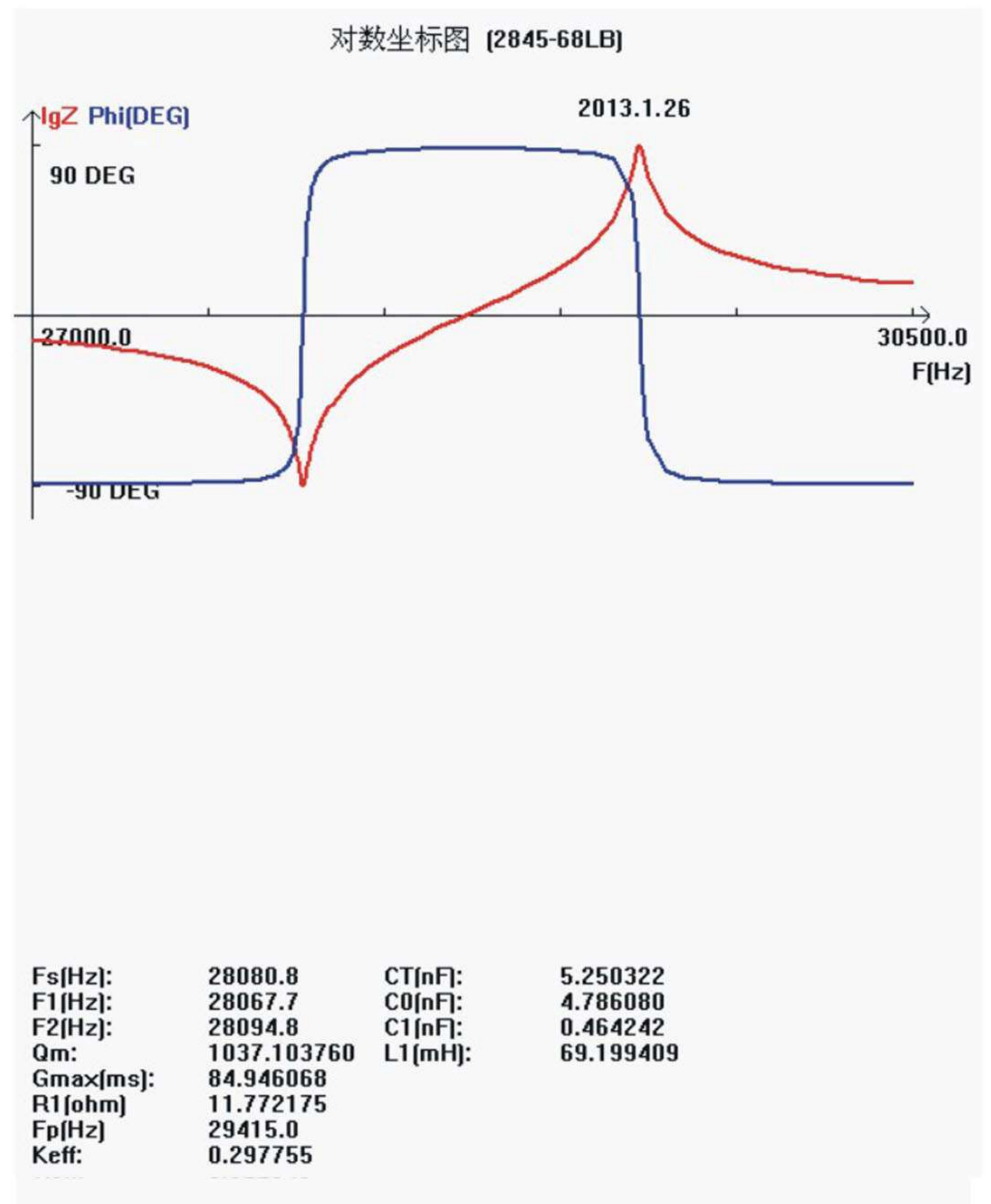
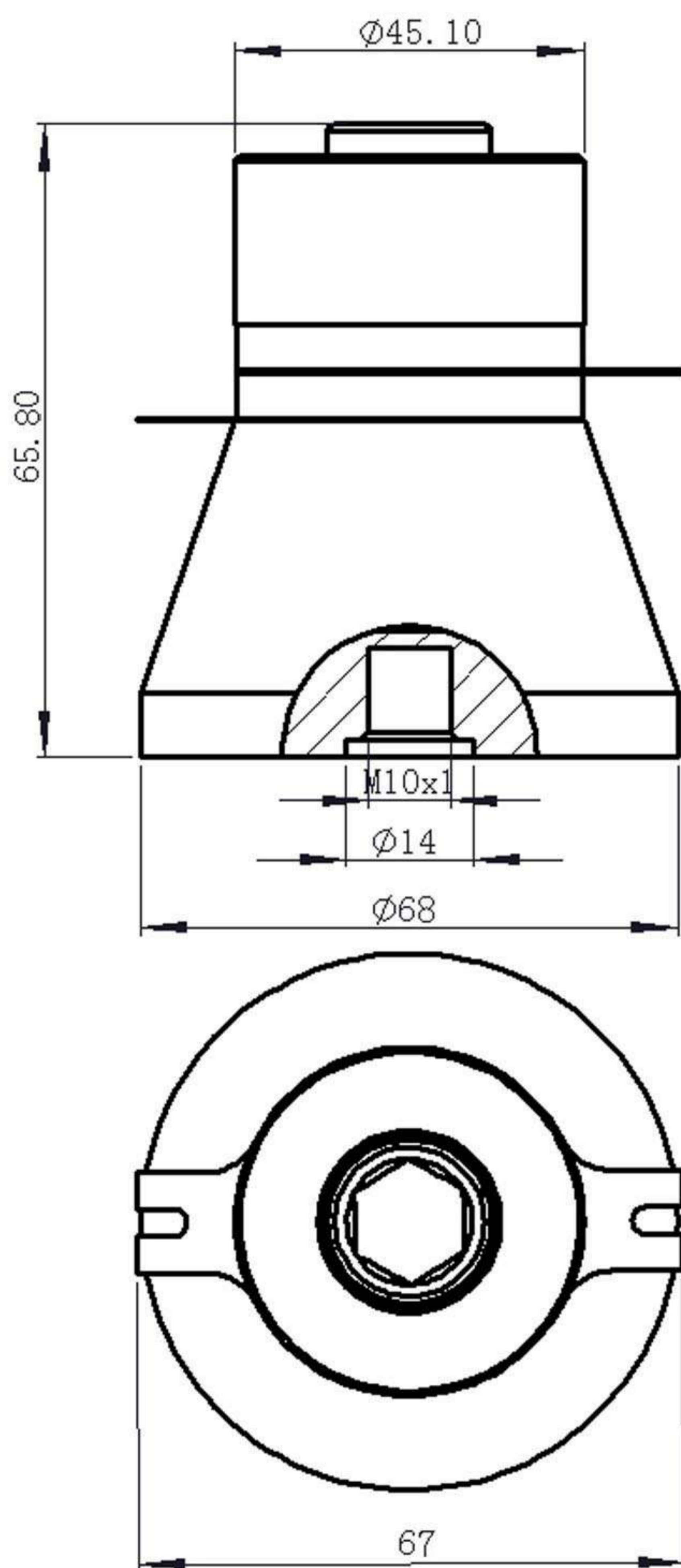
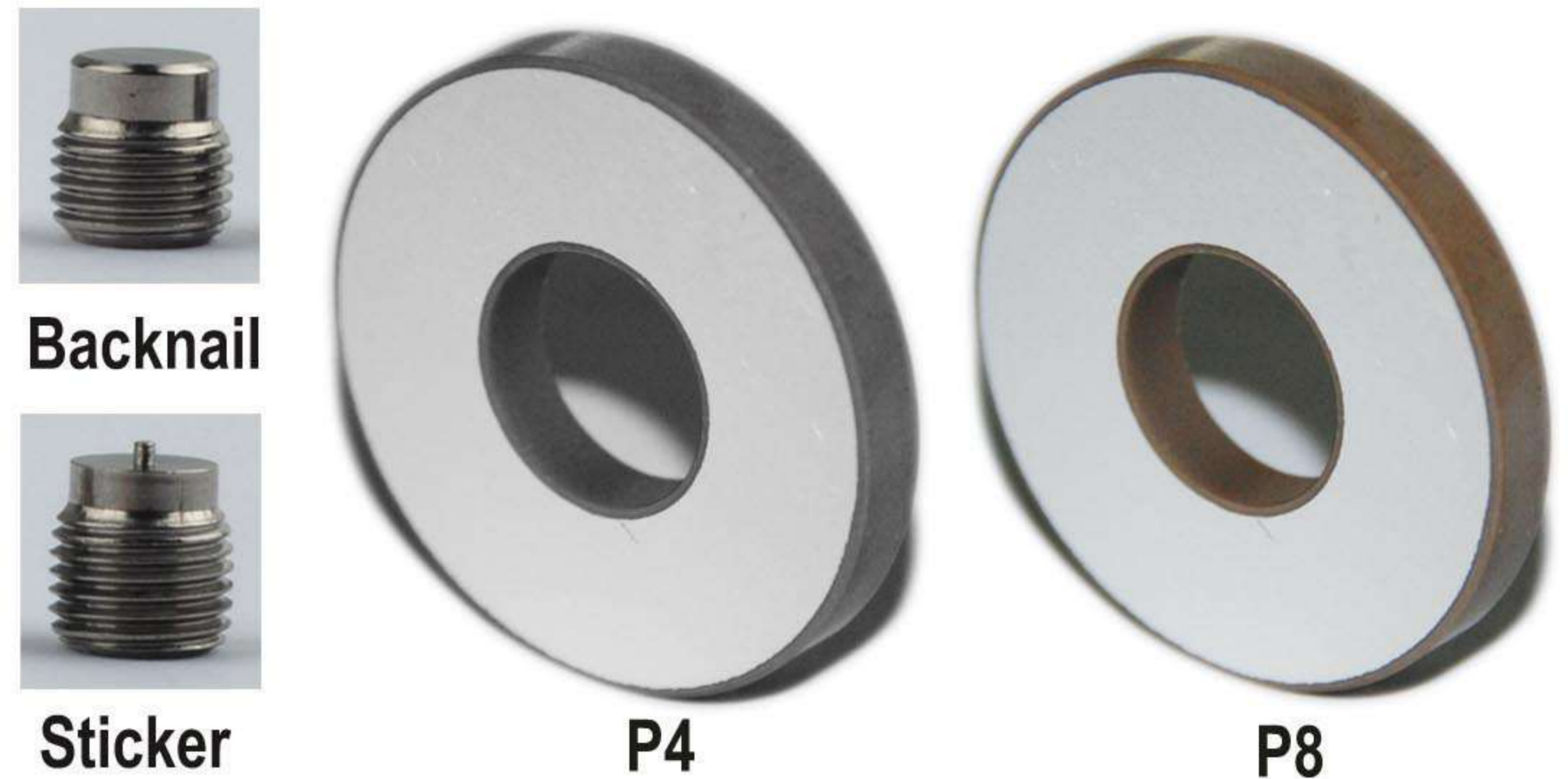

Tel:086-576-87276622 Email:info@clangsonic.com

Website:www.clangsonic.com