

SAW Bandpass Filter 204167B



1. Features

- IF Bandpass Filter
- Low-Loss Filter
- Single-Ended Operation
- Ceramic Surface Mount Device (SMD) Package
- Maximum Storage Temperature Range : -40 °C ~ 85 °C
- Electrostatics Sensitive Device (ESD)

2. Package Dimensions

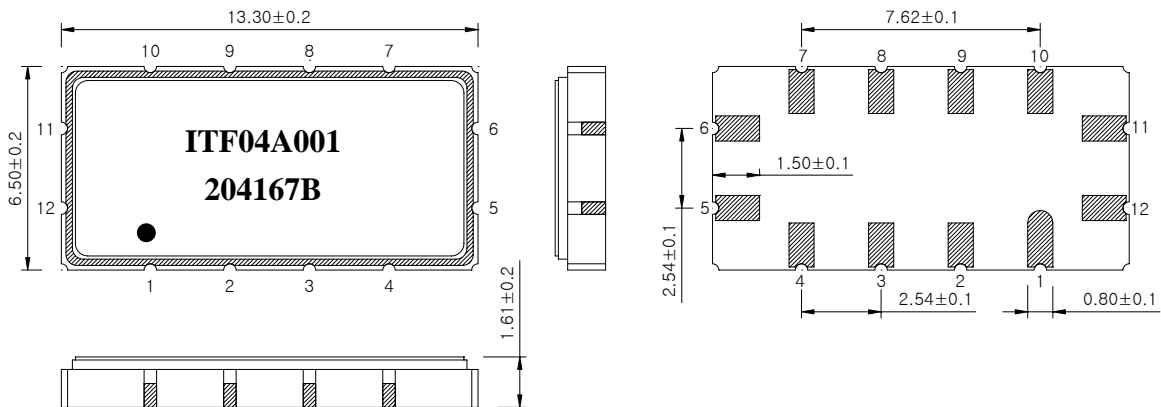

Package : S1365

Dimensions shown are nominal in millimeters

Body : Al₂O₃ Ceramic

Lid : Kovar, Ni Plated

Terminations : Au plating 0.3 ~ 1.0 um, Over a 1.27 ~ 8.89 um Ni Plating

Pad Configuration	
11	Input
5	Output
6, 12	Ground
Other	Case ground



ITF Co., Ltd.
 102-901, Bucheon Technopark 364,
 Samjeong-Dong, Ojeong-Gu, Bucheon-City,
 Gyeonggi-Do, Korea 421-809

Part No.	204167B	
Rev. Date	2004-04-02	
Rev.	NW3006-CS03	1/5

SAW Bandpass Filter 204167B



3. Specifications

Fo = 70.0 MHz

Terminating source impedance : 50Ω and matching network

Terminating load impedance : 50Ω and matching network

		Minimum	Typical	Maximum
Center Frequency	MHz	69.95	70.0	70.05
Insertion Loss	dB	-	11.0	12.5
1dB Bandwidth	MHz	-	1.1	-
3dB Bandwidth	MHz	1.5	1.6	-
40dB Bandwidth	MHz	-	3.15	3.3
Amplitude Ripple (Fo +/- 0.3 MHz)	dB	-	0.5	0.8
Group Delay Variation (Fo +/- 0.3 MHz)	nsec	-	180	250
Absolute Delay	usec	-	1.67	-
Ultimate Rejection	dB	40	45	-
Temperature Coefficient of Frequency	ppm/°C	-	-23	-

Notes :

- 1) All specifications are based on the matching schematic shown below
- 2) All specifications are measured by Agilent Network analyzer and full 2 port calibration at room temperature
- 3) All attenuation measurements are measured relative to insertion loss

 Integrated Technology Future	ITF Co., Ltd. 102-901, Bucheon Technopark 364, Samjeong-Dong, Ojeong-Gu, Bucheon-City, Gyeonggi-Do, Korea 421-809	Part No.	204167B	
		Rev. Date	2004-04-02	
		Rev.	NW3006-CS03	2/5

SAW Bandpass Filter 204167B



4. Matching Schematic

(Actual matching values may vary due to PCB layout and parasitics)

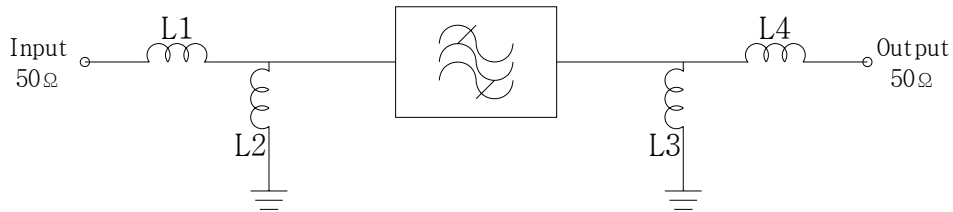

L1 = 150 nH, L4 = 150 nH
 L2 = 220 nH L3 = 220 nH

5. Marking Configuration

ITF¹⁾ 04A001²⁾

204167B³⁾

● 4)

- 1) Manufacturer name
- 2) Lot Number
- 3) Part Number
- 4) Pad Number 1 Index

	ITF Co., Ltd. 102-901, Bucheon Technopark 364, Samjeong-Dong, Ojeong-Gu, Bucheon-City, Gyeonggi-Do, Korea 421-809	Part No.	204167B	
		Rev. Date	2004-04-02	
		Rev.	NW3006-CS03	3/5

SAW Bandpass Filter 204167B



6. Typical Performance (at +25°C)

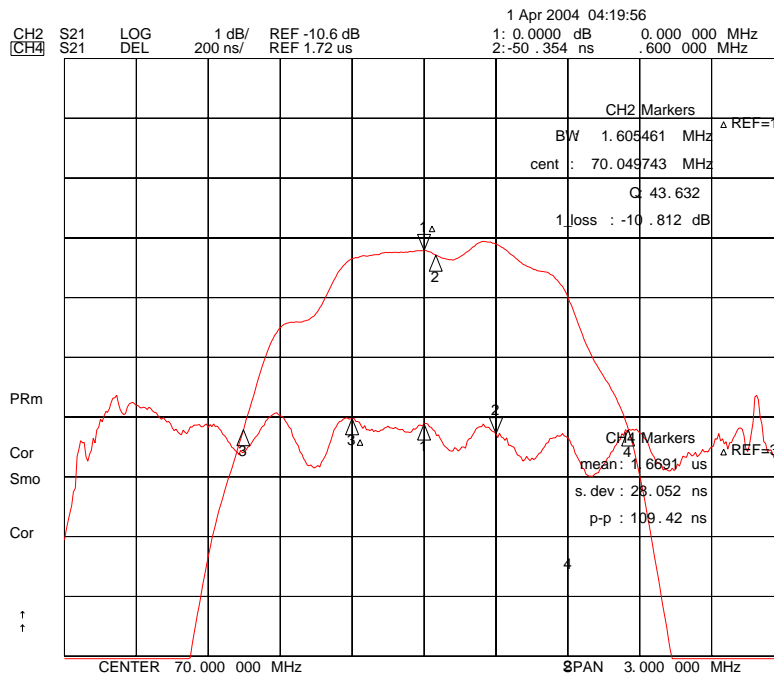
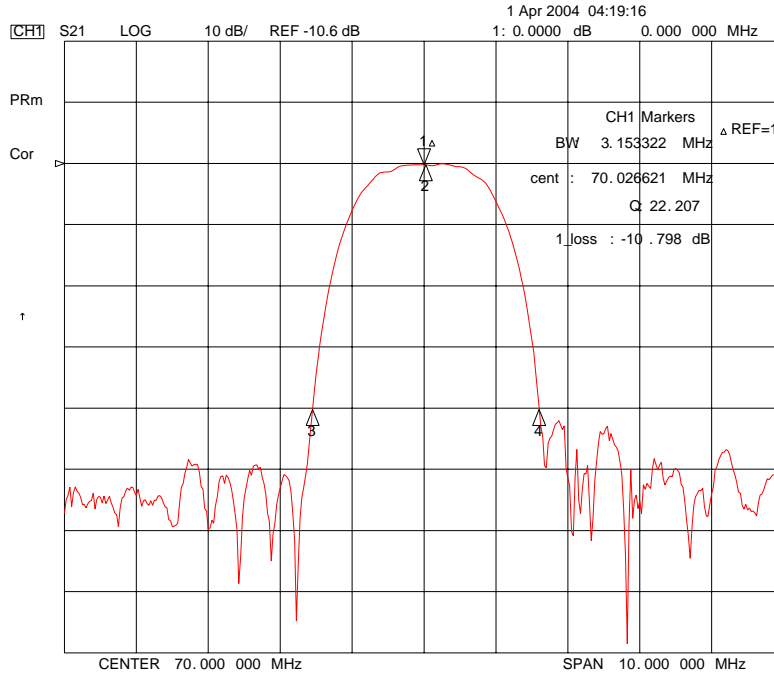

ITF Co., Ltd.
 102-901, Bucheon Technopark 364,
 Samjeong-Dong, Ojeong-Gu, Bucheon-City,
 Gyeonggi-Do, Korea 421-809

Part No.	204167B	
Rev. Date	2004-04-02	
Rev.	NW3006-CS03	4/5

SAW Bandpass Filter 204167B

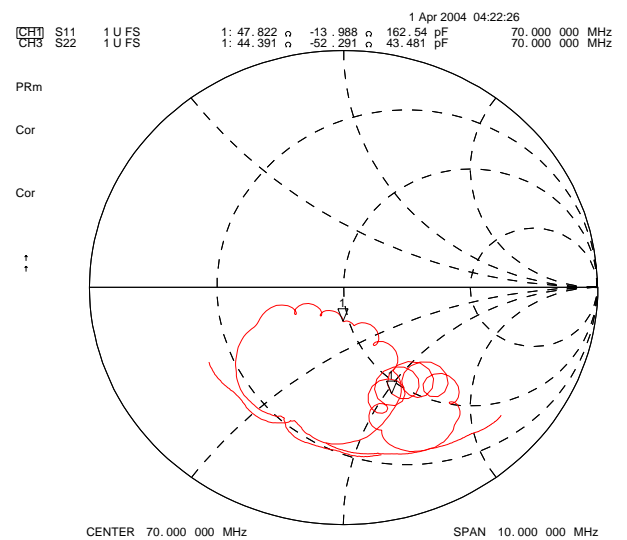
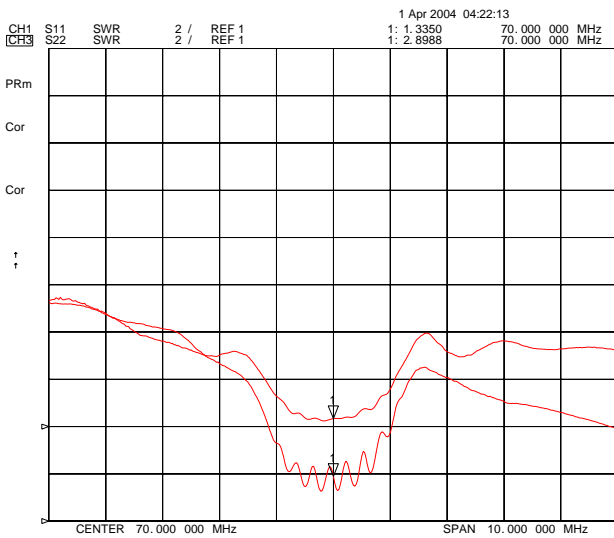
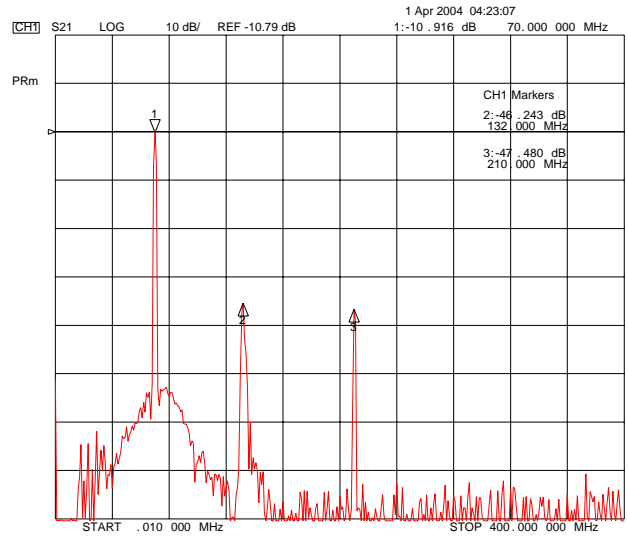
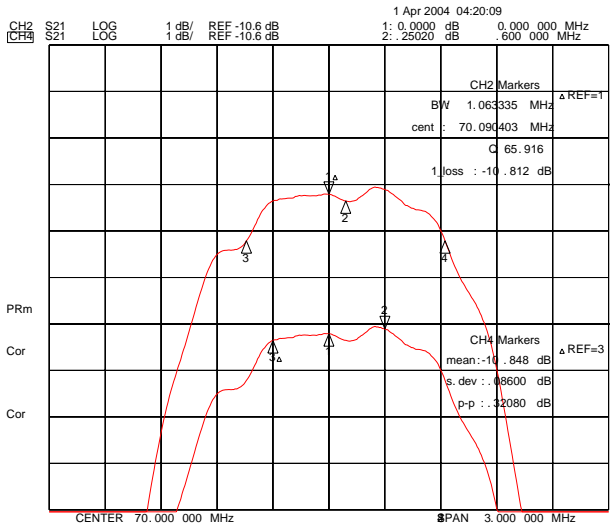

ITF Co., Ltd.
 102-901, Bucheon Technopark 364,
 Samjeong-Dong, Ojeong-Gu, Bucheon-City,
 Gyeonggi-Do, Korea 421-809

Part No. 204167B

Rev. Date 2004-04-02

Rev. NW3006-CS03 5/5