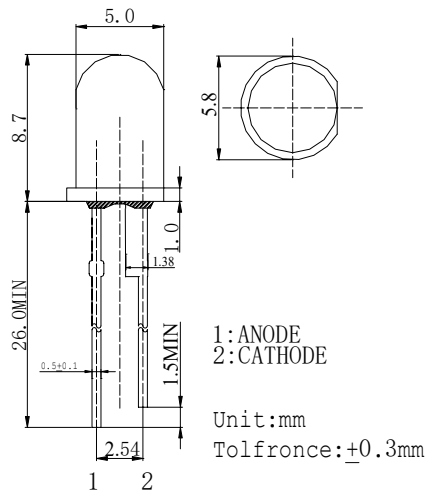

■Features

- High Power LEDs
- 5ø Standard Directivity
- Superior Weather-resistance
- UV Resistant Epoxy
- Water Clear Type

■Applications

- Automotive Dashboard Lighting
- Back Lighting

■Outline Dimension

■Absolute Maximum Rating (Ta=25°C)

Item	Symbol	Value	Unit
DC Forward Current	I_F	100	mA
Pulse Forward Current*	I_{FP}	150	mA
Reverse Voltage	V_R	5	V
Power Dissipation	P_D	500	mW
Operating Temperature	T_{opr}	-30 ~ +80	°C
Storage Temperature	T_{stg}	-30 ~ +100	°C
Lead Soldering Temperature	T_{sol}	260°C/3sec	-

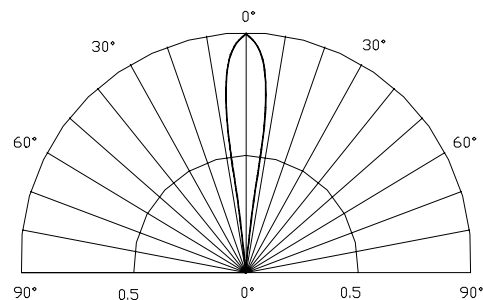
*Pulse width Max.10ms Duty ratio max 1/10

■Directivity

■Electrical -Optical Characteristics (Ta=25°C)

Item	Symbol	Condition	Min.	Typ.	Max.	Unit
DC Forward Voltage	V_F	$I_F=75mA$	1.8	2.2	2.6	V
DC Reverse Current	I_R	$V_R=5V$	-	-	10	μA
Domi. Wavelength	λ_D	$I_F=75mA$	585	590	595	nm
Luminous Intensity	I_v	$I_F=75mA$	30000	50000	70000	mcd
50% Power Angle	$2\theta_{1/2}$	$I_F=75mA$	-	15	-	deg