

## NIS-7 lenses for Nichia 083/183 LEDs



NIS-7-M



NIS-7-MD



NIS-7-W



NIS-7-WW

- Lens material optical grade PMMA with high UV and temperature resistance (105°C/220°F)
- High optical efficiency, >85%
- No lens holder. Attaching of the lens to customer's heat sink by gluing. For detailed mounting information, please look at the drawing
- Diameter 38 mm (MR11)

## LENS TYPES

NAME	ORDERING CODE	FWHM Angle
NIS-7 Medium	C10373_NIS-7-M	±10°
NIS-7 MD	C10633_NIS-7-MD	±13°
NIS-7 Wide	C10585_NIS-7-W	±19°
NIS-7 WW	C10586_NIS-7-WW	±27°

© Ledil Oy - PRELIMINARY - Subject to change without prior notice

## C10373\_NIS-7-M

Relative Intensity of C10373\_NIS-7-M

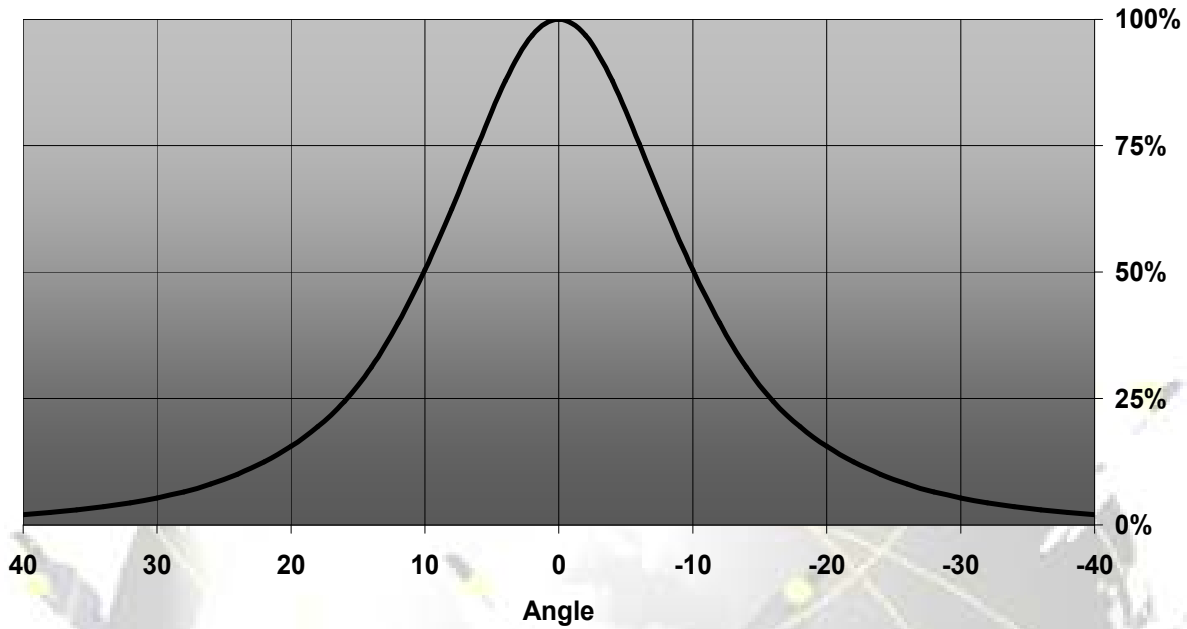

## C10633\_NIS-7-MD

Relative Intensity of C10633\_NIS-7-MD

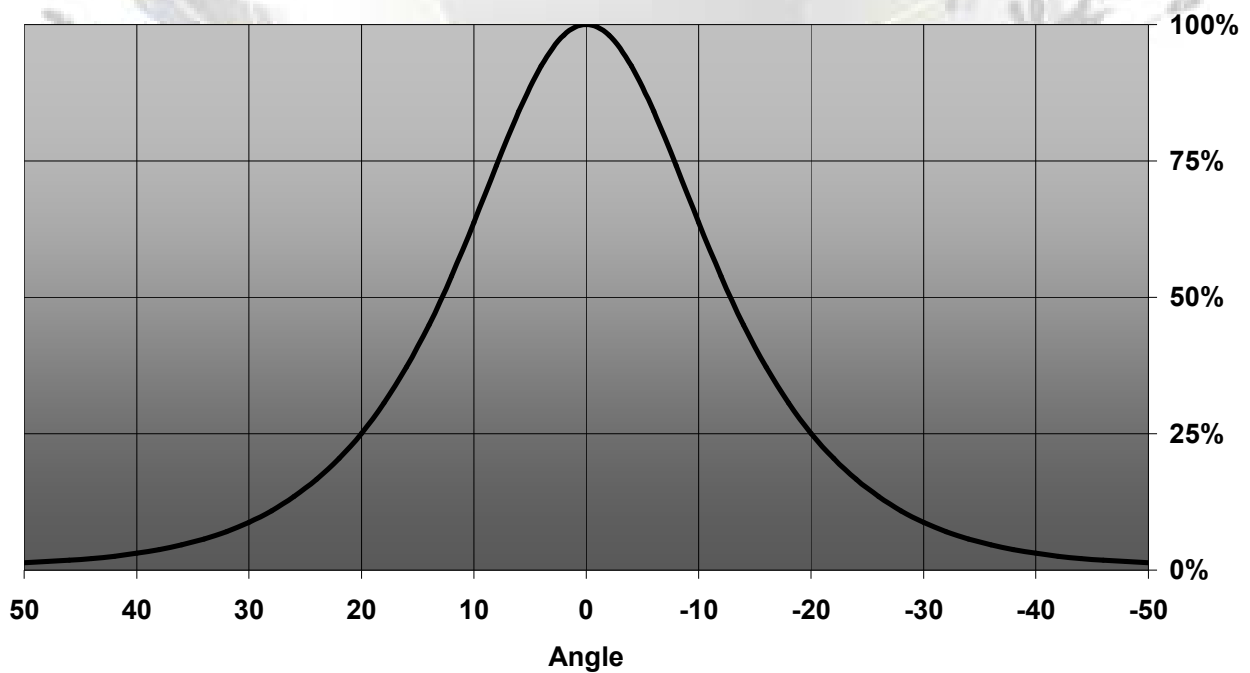

© Ledil Oy - PRELIMINARY - Subject to change without prior notice

## C10585\_NIS-7-W

Relative Intensity of C10585\_NIS-7-W

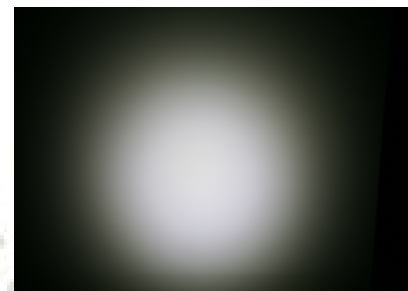
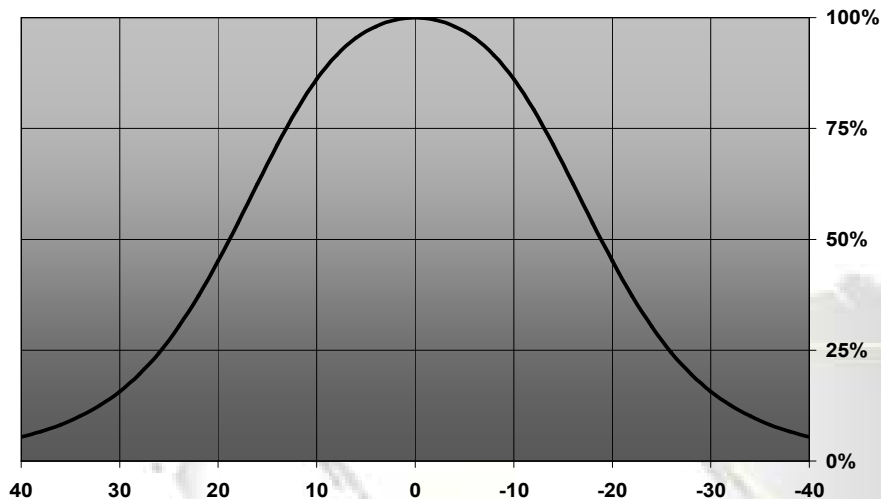

## C10586\_NIS-7-WW

Relative Intensity of C10586\_NIS-7-WW

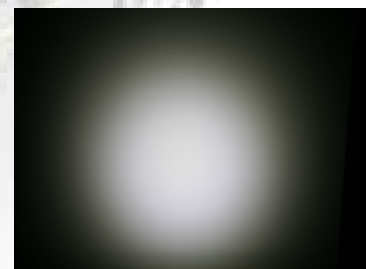
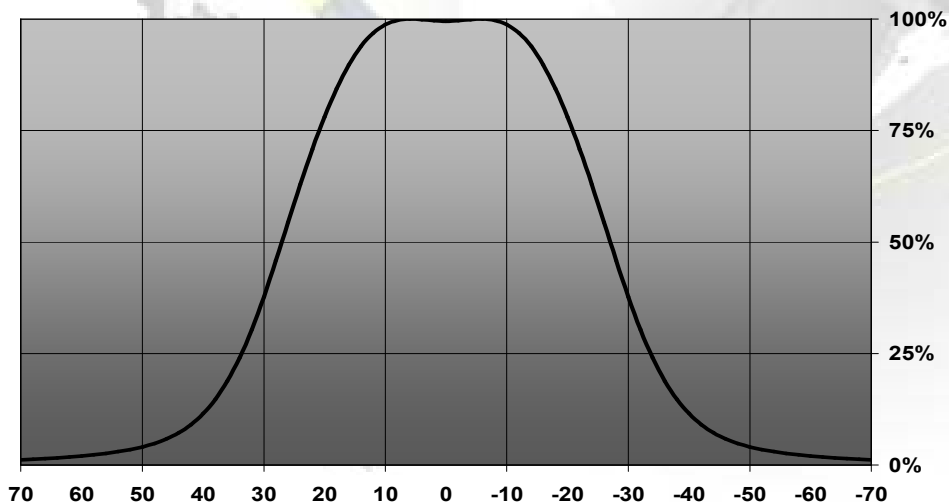

## DIMENSIONS & PCB LAYOUT

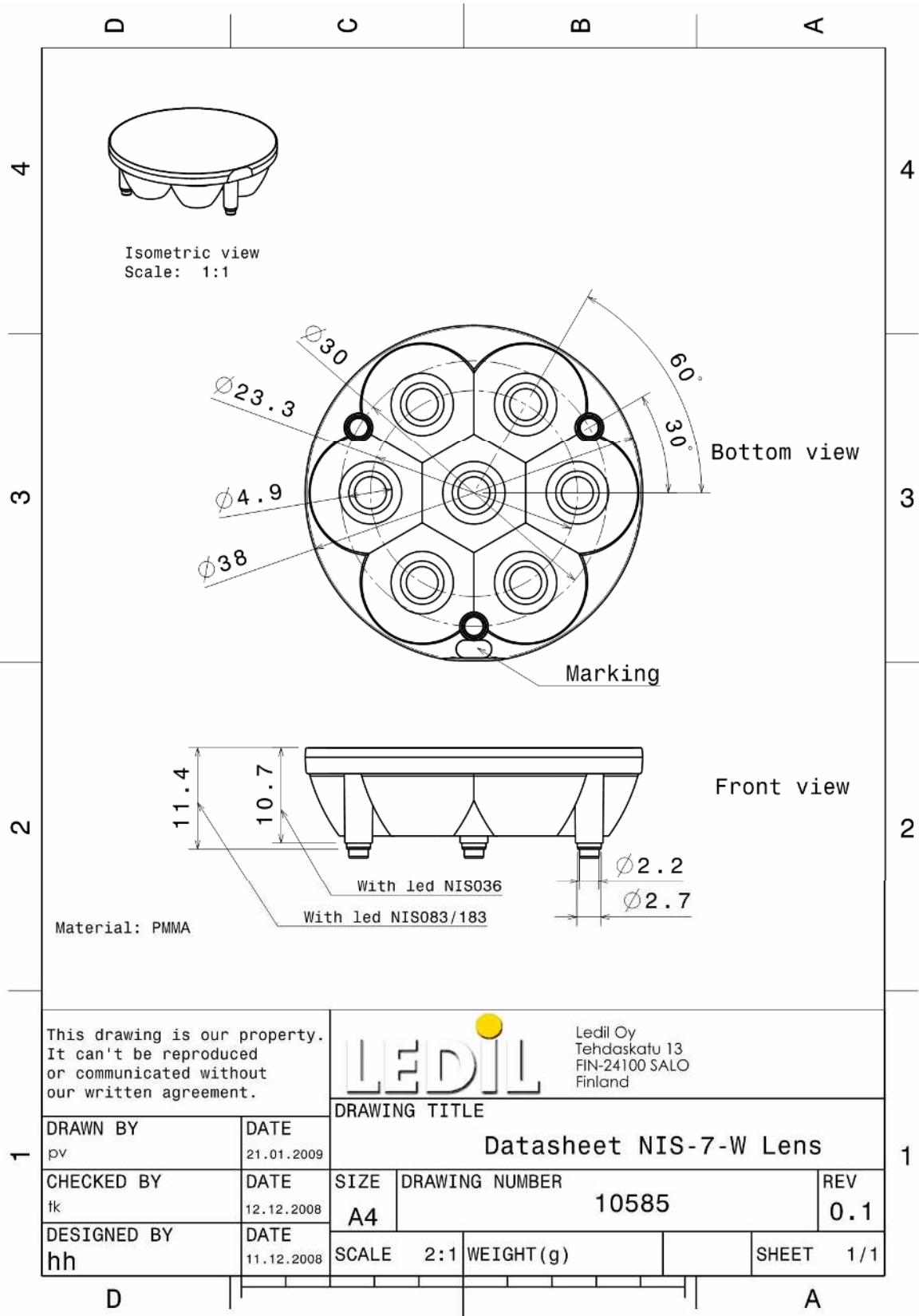

© Ledil Oy - PRELIMINARY - Subject to change without prior notice