

## CM Series



Due to accurate wire winding technology, these chip inductors are designed for filtering impedance matching, resonance and choke circuits for RF designer. Both standard series and custom designs are available.

### Features

- ☑ RoHS Compliant
- ☑ Ceramic body and wire wound construction provide high SRFs
- ☑ Exceptional Q value even at high frequencies
- ☑ Ceramic construction delivers the highest possible SRFs as well as high Q value
- ☑ Low DC resistance design supports low loss, high output and low power consumption
- ☑ CM series is standard for RF designers

### Applications

- ☑ RF products for cellular phone
- ☑ GPS receiver
- ☑ Base Station
- ☑ Repeater
- ☑ Wireless LAN/ mouse/ keyboard/ earphone
- ☑ Remote control
- ☑ Security system and other RF modules

### Product Identification

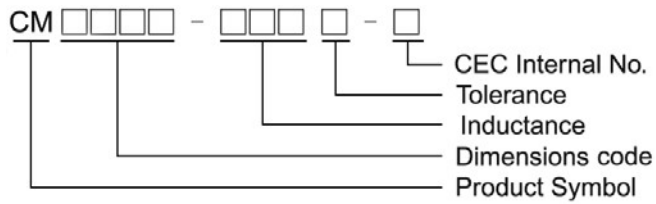

### Shape and Dimensions / Recommended Pattern

**CM0402**

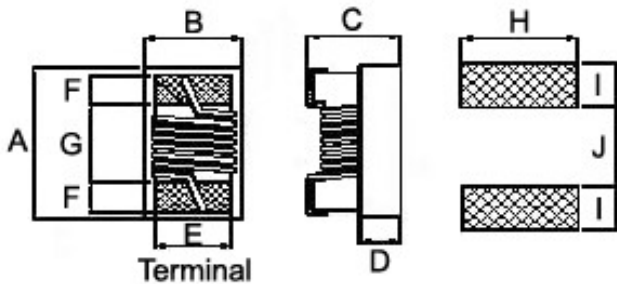

**CM0603**

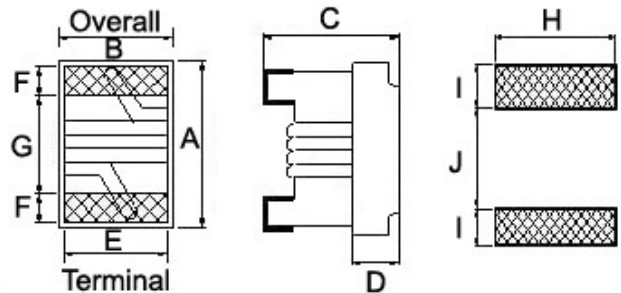

Dimensions

	A Max	B Max	C Max	D	E	F	G	H	I	J
<b>CM0402</b>	1.05 $\pm$ 0.05	0.60 $\pm$ 0.05	0.5 $\pm$ 0.05	0.25	0.40	0.20	0.54	0.56	0.36	0.46
<b>CM0603</b>	1.6 $^{+0.2}_{-0.1}$	1.02 $\pm$ 0.1	0.82 $^{+0.2}_{-0.1}$	0.35	0.70	0.30	0.95	1.02	0.64	0.64

# SMD Wire Wound Ceramic Chip Inductors - CM Series

## Electrical Characteristics

Part Number	Inductance (nH)	Tolerance (±%)	Test Frequency (MHz)	Q Min	Test Frequency (MHz)	SRF (GHz) Min	RDC (Ω) Max	I <sub>rms</sub> (mA) Max
CM0402-1N5□ -N	1.5	±0.1nH/±0.2nH/±0.5nH	100	10	250	18.0	0.03	1000
CM0402-2N4□ -N	2.4	±0.1nH/±0.2nH/±0.5nH	100	20	250	15.0	0.05	850
CM0402-2N5□ -N	2.5	±0.1nH/±0.2nH/±0.5nH	100	20	250	15.0	0.05	850
CM0402-2N7□ -N	2.7	±0.1nH/±0.2nH/±0.5nH	100	20	250	15.0	0.05	850
CM0402-2N9□ -N	2.9	±0.1nH/±0.2nH/±0.5nH	100	20	250	15.0	0.07	750
CM0402-3N9□ -N	3.9	3 / 5	100	25	250	10.0	0.07	750
CM0402-4N1□ -N	4.1	3 / 5	100	25	250	10.0	0.07	750
CM0402-4N3□ -N	4.3	3 / 5	100	25	250	10.0	0.07	750
CM0402-4N7□ -N	4.7	3 / 5	100	25	250	8.0	0.07	750
CM0402-5N1□ -N	5.1	3 / 5	100	25 typ	250	8.0	0.12	600
CM0402-5N8□ -N	5.8	3 / 5	100	25	250	8.0	0.12	700
CM0402-6N2□ -N	6.2	3 / 5	100	25	250	8.0	0.09	700
CM0402-6N8□ -N	6.8	3 / 5	100	25	250	6.0	0.09	700
CM0402-7N3□ -N	7.3	3 / 5	100	25	250	6.0	0.13	570
CM0402-7N5□ -N	7.5	3 / 5	100	25	250	6.0	0.13	570
CM0402-8N2□ -N	8.2	3 / 5	100	25	250	5.5	0.14	540
CM0402-8N7□ -N	8.7	3 / 5	100	25	250	5.5	0.14	540
CM0402-9N1□ -N	9.1	3 / 5	100	25	250	5.5	0.14	540
CM0402-9N5□ -N	9.5	3 / 5	100	25	250	5.5	0.14	540
CM0402-10N□ -N	10	2 / 3 / 5	100	25	250	5.5	0.17	500
CM0402-11N□ -N	11	2 / 3 / 5	100	30	250	5.5	0.14	500
CM0402-12N□ -N	12	2 / 3 / 5	100	30	250	5.5	0.14	500
CM0402-13N□ -N	13	2 / 3 / 5	100	25	250	5.0	0.21	430
CM0402-15N□ -N	15	2 / 3 / 5	100	30	250	5.0	0.16	460
CM0402-16N□ -N	16	2 / 3 / 5	100	25	250	4.5	0.24	370
CM0402-18N□ -N	18	2 / 3 / 5	100	25	250	4.5	0.27	370
CM0402-19N□ -N	19	2 / 3 / 5	100	25	250	4.5	0.27	370
CM0402-20N□ -N	20	2 / 3 / 5	100	25	250	4.0	0.27	370
CM0402-22N□ -N	22	2 / 3 / 5	100	25	250	4.0	0.30	310
CM0402-23N□ -N	23	2 / 3 / 5	100	25	250	3.8	0.30	310
CM0402-24N□ -N	24	2 / 3 / 5	100	25	250	3.5	0.52	280
CM0402-27N□ -N	27	2 / 3 / 5	100	25	250	3.5	0.52	280
CM0402-30N□ -N	30	2 / 3 / 5	100	25	250	3.3	0.58	270
CM0402-33N□ -N	33	2 / 3 / 5	100	25	250	3.2	0.63	260
CM0402-36N□ -N	36	2 / 3 / 5	100	25	250	3.1	0.63	260
CM0402-39N□ -N	39	2 / 3 / 5	100	25	250	3.0	0.70	250
CM0402-40N□ -N	40	2 / 3 / 5	100	25	250	3.0	0.70	250
CM0402-47N□ -N	47	2 / 3 / 5	100	25	200	2.9	1.08	210
CM0402-51N□ -N	51	2 / 3 / 5	100	25	200	2.85	1.08	210
CM0402-56N□ -N	56	2 / 3 / 5	100	25	200	2.80	1.17	200
CM0402-62N□ -N	62	2 / 3 / 5	100	20	200	2.60	1.82	145

**Note: When ordering, please specify tolerance code. Tolerance : B=±0.1nH , C=±0.2nH , D=±0.5nH , G=±2% , H=±3% , J=±5%**

☐ Operating temperature range – 40°C~125°C(Including self - temperature rise)

☐ I<sub>rms</sub> for a 15°C temperature rise from 25°C ambient with current

☐ Measure Equipment :

L & Q : Agilent E4991A+Agilent HP16197A

SRF : Agilent HP8753D/Agilent HP8722ES

RDC : DIGITAL MILLINHM METER CHROMA 16502

I<sub>rms</sub> : HP4284A+HP42841A/HP4285A+HP42841A



CHILISIN ELECTRONICS CORP.

# SMD Wire Wound Ceramic Chip Inductors - CM Series

## Electrical Characteristics

Part Number	Inductance (nH)	Tolerance (±%)	Test Frequency (MHz)	Q Min	Test Frequency (MHz)	SRF (GHz) Min	RDC (Ω) Max	Irms (mA) Max
CM0402-68N□ -N	68	2 / 3 / 5	100	20	200	2.50	1.96	140
CM0402-72N□ -N	72	2 / 3 / 5	100	20	150	2.50	2.10	135
CM0402-75N□ -N	75	2 / 3 / 5	100	20	150	2.40	2.10	135
CM0402-82N□ -N	82	2 / 3 / 5	100	20	150	2.30	2.24	130
CM0402-91N□ -N	91	2 / 3 / 5	100	20	150	2.10	2.38	125
CM0402-R10□ -N	100	2 / 3 / 5	100	20	150	1.50	2.52	120
CM0402-R12□ -N	120	2 / 3 / 5	100	20	150	1.00	2.66	110

Note: When ordering, please specify tolerance code. Tolerance : B=±0.1nH , C=±0.2nH , D=±0.5nH , G=±2% , H=±3% , J=±5%

Operating temperature range – 40°C~125°C(Including self - temperature rise)

Irms for a 15°C temperature rise from 25°C ambient with current

Measure Equipment :

L & Q : Agilent E4991A+Agilent HP16197A

SRF : Agilent HP8753D/Agilent HP8722ES

RDC : DIGITAL MILLINHM METER CHROMA 16502

Irms : HP4284A+HP42841A/HP4285A+HP42841A

Typical L vs. Frequency

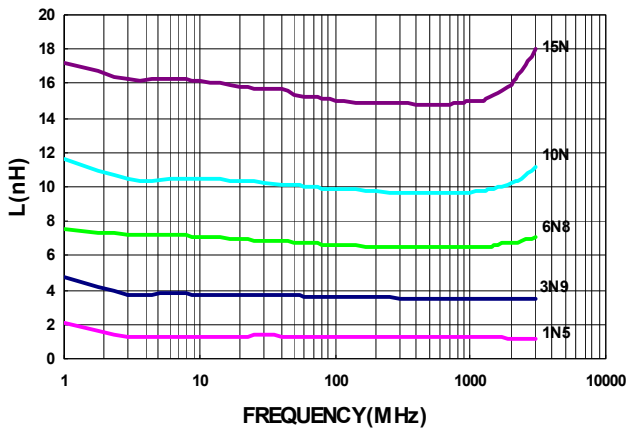

Typical Q vs. Frequency

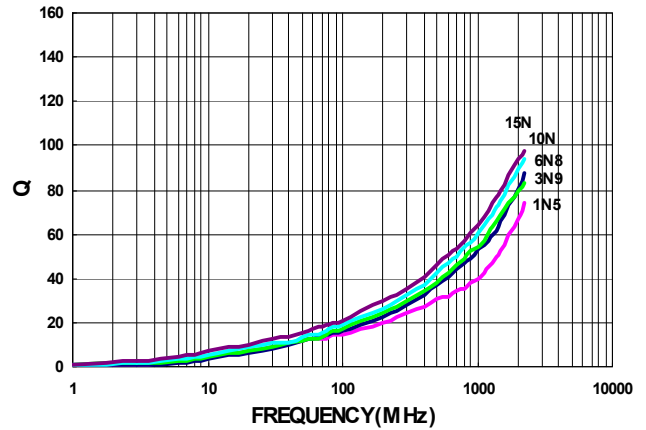

# SMD Wire Wound Ceramic Chip Inductors - CM Series

## Electrical Characteristics

Part Number	Inductance (nH)	Tolerance (±%)	Test Frequency (MHz)	Q Min	Test Frequency (MHz)	SRF (GHz) Min	RDC (Ω) Max	I <sub>rms</sub> (mA) Max
CM0603-2N2□ -N	2.2	±0.1nH/±0.2nH/±0.5nH	100	16	250	6.0	0.049	700
CM0603-3N6□ -N	3.6	3 / 5	100	25	250	6.0	0.059	850
CM0603-3N9□ -N	3.9	3 / 5	100	35	250	6.0	0.059	850
CM0603-4N3□ -N	4.3	3 / 5	100	35	250	6.0	0.059	850
CM0603-4N7□ -N	4.7	3 / 5	100	35	250	6.0	0.059	850
CM0603-5N6□ -N	5.6	3 / 5	100	35	250	6.0	0.082	750
CM0603-6N2□ -N	6.2	3 / 5	100	35	250	6.0	0.082	750
CM0603-6N8□ -N	6.8	3 / 5	100	35	250	6.0	0.082	750
CM0603-7N5□ -N	7.5	3 / 5	100	35	250	6.0	0.082	750
CM0603-8N2□ -N	8.2	3 / 5	100	35	250	6.0	0.110	650
CM0603-8N7□ -N	8.7	3 / 5	100	35	250	6.0	0.110	650
CM0603-9N1□ -N	9.1	3 / 5	100	35	250	6.0	0.110	650
CM0603-9N5□ -N	9.5	3 / 5	100	35	250	6.0	0.110	650
CM0603-10N□ -N	10	2 / 3 / 5	100	35	250	6.0	0.110	650
CM0603-11N□ -N	11	2 / 3 / 5	100	35	250	6.0	0.110	650
CM0603-12N□ -N	12	2 / 3 / 5	100	35	250	6.0	0.130	600
CM0603-13N□ -N	13	2 / 3 / 5	100	35	250	6.0	0.130	600
CM0603-15N□ -N	15	2 / 3 / 5	100	40	250	6.0	0.130	600
CM0603-16N□ -N	16	2 / 3 / 5	100	40	250	5.5	0.160	550
CM0603-18N□ -N	18	2 / 3 / 5	100	40	250	5.5	0.160	550
CM0603-20N□ -N	20	2 / 3 / 5	100	40	250	4.9	0.160	550
CM0603-22N□ -N	22	2 / 3 / 5	100	40	250	4.6	0.170	500
CM0603-24N□ -N	24	2 / 3 / 5	100	40	250	3.8	0.210	500
CM0603-27N□ -N	27	2 / 3 / 5	100	40	250	3.7	0.210	440
CM0603-30N□ -N	30	2 / 3 / 5	100	40	250	3.3	0.230	420
CM0603-33N□ -N	33	2 / 3 / 5	100	40	250	3.2	0.230	420
CM0603-36N□ -N	36	2 / 3 / 5	100	40	250	2.9	0.260	400
CM0603-39N□ -N	39	2 / 3 / 5	100	40	250	2.8	0.260	400
CM0603-43N□ -N	43	2 / 3 / 5	100	40	200	2.7	0.290	380
CM0603-47N□ -N	47	2 / 3 / 5	100	38	200	2.6	0.290	380
CM0603-51N□ -N	51	2 / 3 / 5	100	38	200	2.5	0.330	370
CM0603-56N□ -N	56	2 / 3 / 5	100	38	200	2.4	0.350	360
CM0603-62N□ -N	62	2 / 3 / 5	100	38	200	2.3	0.510	280
CM0603-68N□ -N	68	2 / 3 / 5	100	38	200	2.2	0.380	340
CM0603-72N□ -N	72	2 / 3 / 5	100	34	150	2.1	0.560	270
CM0603-75N□ -N	75	2 / 3 / 5	100	34	150	2.05	0.560	270
CM0603-82N□ -N	82	2 / 3 / 5	100	34	150	2.00	0.600	250
CM0603-91N□ -N	91	2 / 3 / 5	100	34	150	1.90	0.640	230
CM0603-R10□ -N	100	2 / 3 / 5	100	34	150	1.80	0.680	220
CM0603-R11□ -N	110	2 / 3 / 5	100	32	150	1.70	1.200	200
CM0603-R12□ -N	120	2 / 3 / 5	100	32	150	1.60	1.300	180
CM0603-R13□ -N	130	2 / 3 / 5	100	32	150	1.45	1.400	170
CM0603-R15□ -N	150	2 / 3 / 5	100	32	150	1.40	1.500	160

**Note:** When ordering, please specify tolerance code. Tolerance : B=±0.1nH , C=±0.2nH , D=±0.5nH , G=±2% , H=±3% , J=±5%

☐ Operating temperature range – 40°C~125°C(Including self - temperature rise)

☐ I<sub>rms</sub> for a 15°C temperature rise from 25°C ambient with current

☐ Measure Equipment :

L & Q : Agilent E4991A+Agilent HP16197A

SRF : Agilent HP8753D/Agilent HP8722ES

RDC : DIGITAL MILLINHM METER CHROMA 16502

I<sub>rms</sub> : HP4284A+HP42841A/HP4285A+HP42841A



# SMD Wire Wound Ceramic Chip Inductors - CM Series

## Electrical Characteristics

Part Number	Inductance (Nh)	Tolerance (±%)	Test Frequency (MHz)	Q Min	Test Frequency (MHz)	SRF (GHz) Min	RDC (Ω) Max	Irms (mA) Max
CM0603-R16□ -N	160	2 / 3 / 5	100	32	150	1.35	2.100	150
CM0603-R18□ -N	180	2 / 3 / 5	100	25	100	1.30	2.200	140
CM0603-R20□ -N	200	2 / 3 / 5	100	25	100	1.25	2.400	120
CM0603-R22□ -N	220	2 / 3 / 5	100	25	100	1.20	2.500	120
CM0603-R27□ -N	270	2 / 3 / 5	100	30	100	0.96	3.400	110
CM0603-R33□ -N	330	2 / 3 / 5	100	30	100	0.80	5.500	85
CM0603-R39□ -N	390	2 / 3 / 5	100	30	100	0.80	6.200	80
CM0603-R47□ -N	470	2 / 3 / 5	100	30	100	0.70	7.000	75

**Note:** When ordering, please specify tolerance code. Tolerance : B=±0.1nH , C=±0.2nH , D=±0.5nH , G=±2% , H=±3% , J=±5%

☒ Operating temperature range – 40°C~125°C(Including self - temperature rise)

☒ Irms for a 15°C temperature rise from 25°C ambient with current

☒ Measure Equipment :

L & Q : Agilent E4991A+Agilent HP16197A

SRF : Agilent HP8753D/Agilent HP8722ES

RDC : DIGITAL MILLINHM METER CHROMA 16502

Irms : HP4284A+HP42841A/HP4285A+HP42841A

Typical L vs. Frequency

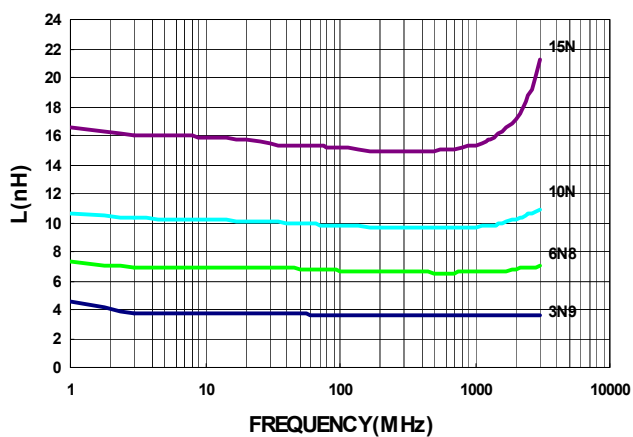

Typical Q vs. Frequency

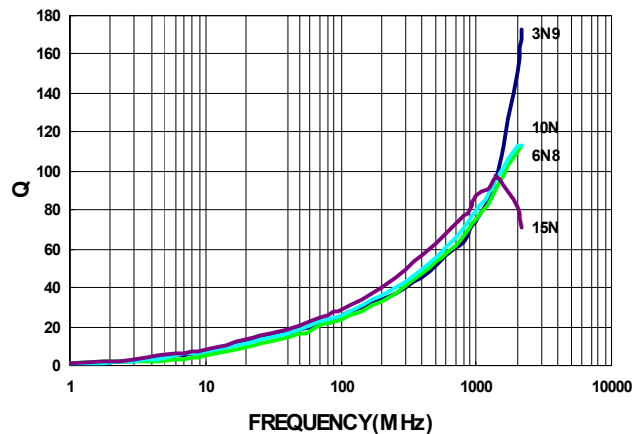

# SMD Wire Wound Ceramic Chip Inductors - CM Series

## Packaging Specifications

### Tape Dimensions

Figure 1

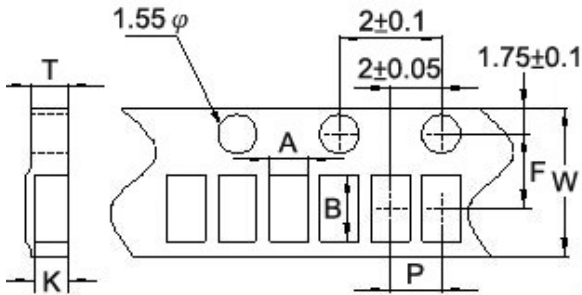

### Tape Material

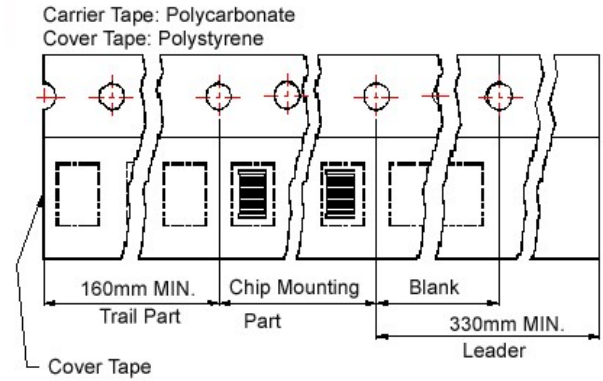
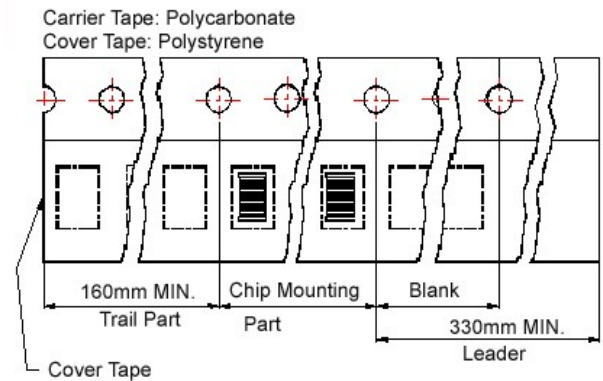
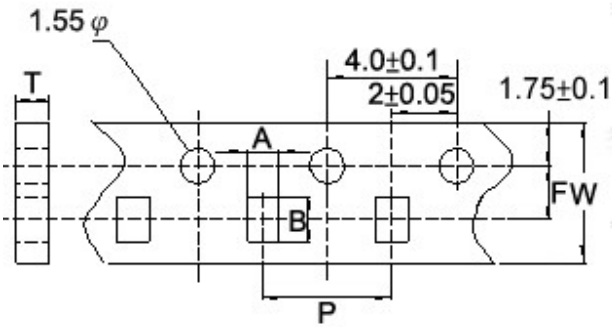
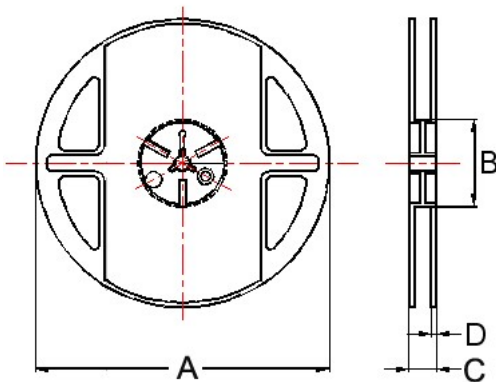

Figure 2



### Reel Dimensions



### Dimensions in mm

TYPE	Fig.	Tape Dimensions							Reel Dimensions				Quantity PCS / Reel
		A	B	T	W	P	F	K	A	B	C	D	
CM0402	1	0.67	1.20	0.75	8	2	3.5	0.53	178	60	12	1.5	4000
CM0603	2	1.20	1.80	0.97	8	4	3.5	-	178	60	12	1.5	4000