

CERAMIC RESONATOR

陶瓷谐振器

ZTA/ZTT SERIES

DIMENSIONS(Unit:mm) 外形尺寸 (ZTA Series)

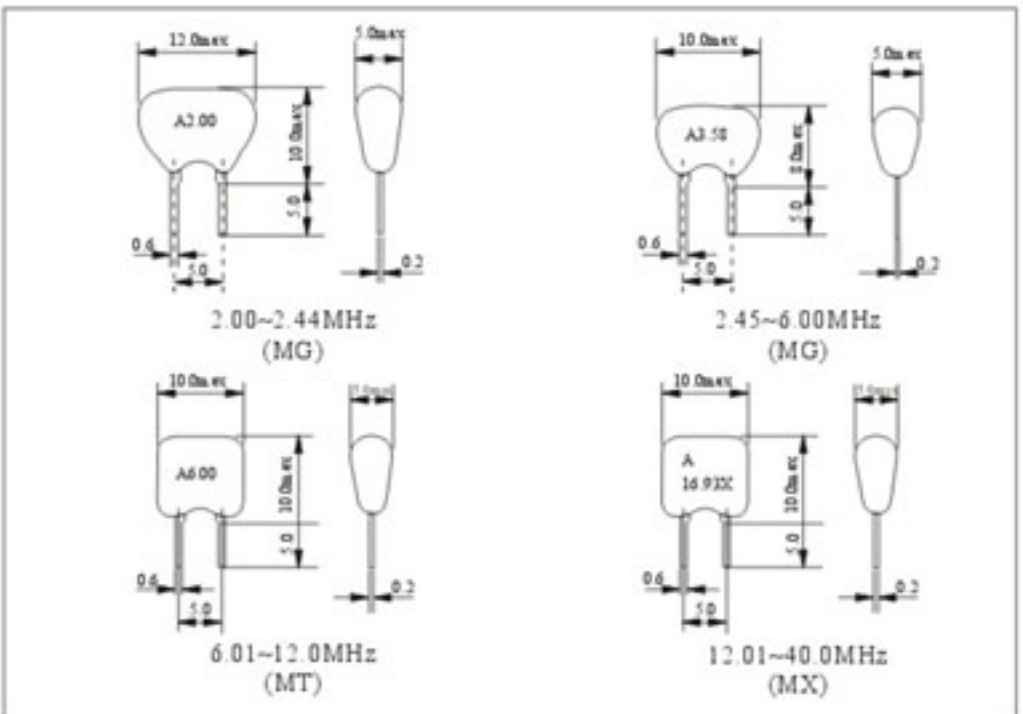
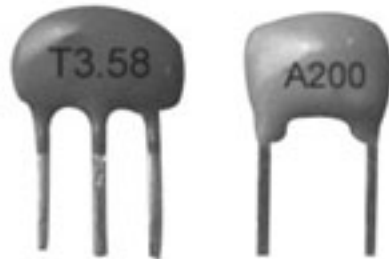

DIMENSIONS(Unit:mm) 外形尺寸 (ZTT Series)

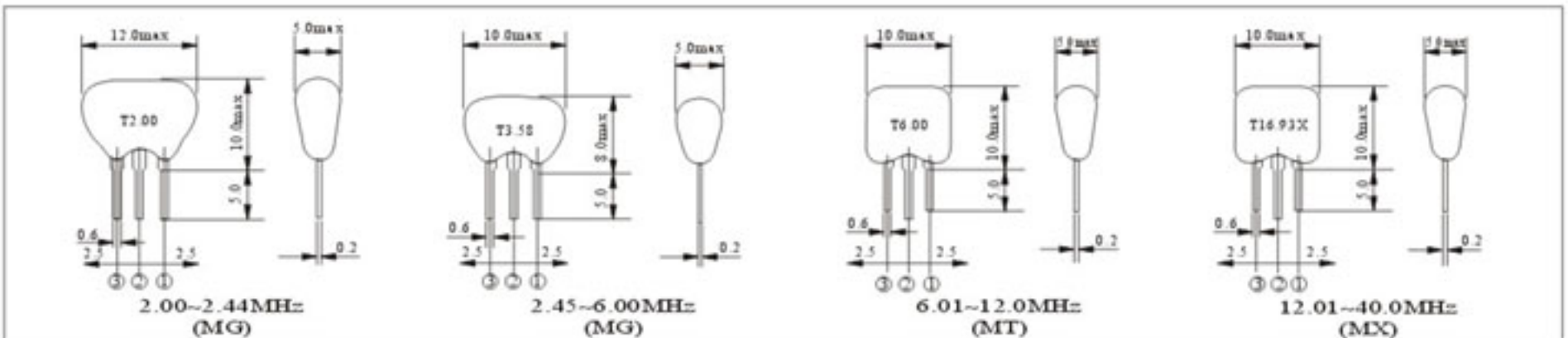

PRINCIPAL PARAMETERS 主要参数

Model 型号	Frequency Range 频率范围 (MHz)	Frequency Accuracy 频率精度 (+25°C)	Temperature Stability 温度稳定性 (-20°C~+80°C)	Operating Temperature 工作温度	Aging(Ten Years) 老化性 (10年)
ZTA□□□MG	2.00 - 6.00	±0.3%	±0.3%	-20°C ~ +80°C	±0.3%
ZTA□□□MT	6.01 - 12.0		±0.5%		±0.5%
ZTA□□□MX	12.01 - 40.0		±0.3%		±0.3%
ZTT□□□MG	2.00 - 6.00	±0.3%	±0.3%	-20°C ~ +80°C	±0.3%
ZTT□□□MT	6.01 - 12.0		±0.5%		±0.5%
ZTT□□□MX	12.01 - 40.0		±0.3%		±0.3%

TEST CIRCUIT 测量线路

1/6CD4069UBEX2 ZTA Series

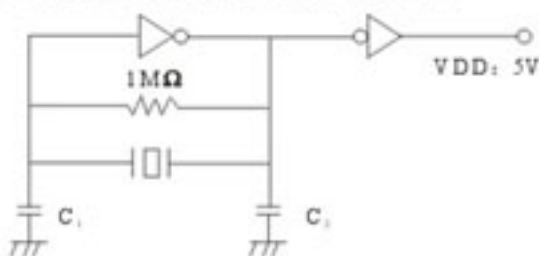

ZTA□□□MG	2.00 - 6.00	C,C,30pF
ZTA□□□MT	6.01 - 12.00	C,C,30pF
ZTA□□□MX	12.01 - 19.99	C,C,15pF
ZTA□□□MX	20.00 - 25.99	C,C,15pF
ZTA□□□MX	26.00 - 40.00	C,C,5pF

1/6CD4069UBEX2 ZTT Series

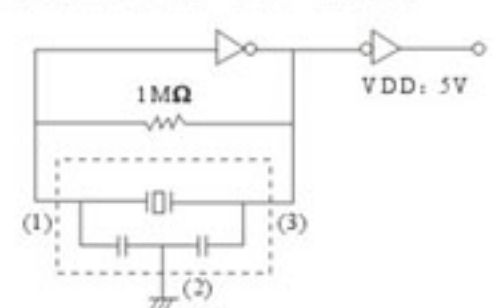

注: ZTA□□□MX, ZTT□□□MX 系列产品 IC 为 TC4069.

Remark: IC used by resonators ZTA□□□MX and ZTT□□□MX series is TC4069.