



● **Application**

Microcomputer, VTR, Toys, TV Game, Telecommunications...etc

● **Specification**

Frequency Range	1.5 ~ 160.0 MHz
Vibration Mode	AT Cut: Fundamental, Third, Fifth
Frequency Tolerance at 25°C	+/-10, +/-15, +/-20, +/-30, +/-50 ppm
Shunt Capacitance	7.0pF max. or specified
Load Capacitance	16, 20, 30pF, Series Resonant or specified
Drive Level	10, 100, 300, 1000uW or specified
Insulation Resistance	500M Ohm min. at DC 100V
Aging	+/- 3, 5 ppm per year or specified

● **Operating Temperature Range & Frequency Stability**

Temp. ppm	+/-3	+/-5	+/-7.5	+/-10	+/-15	+/-20	+/-30	+/-50
0 ~ +50°C	■ O	■ O	■ O	■ O*	■ O*	■ O*	■ O*	■ O*
-10 ~ +60°C	■ O	■ O	■ O	■ O*	■ O*	■ O*	■ O*	■ O*
-20 ~ +70°C		■ O	■ O	■ O	■ O	■ O*	■ O*	■ O*
-30 ~ +80°C				■ O	■ O	■ O	■ O*	■ O*
-40 ~ +90°C				■ O	■ O	■ O	■ O	■ O*

HC49U & 50U Series : O
HC49S Series : *
UM Series : ■

● **Frequency Range & Equivalent Series Resistance (Unit: Ohm)**

Frequency (MHz)	Vibration Mode	HC-49/U HC-50/U	HC-49/U1 HC-50/U1	HC-49/U2 HC-50/U2	HC-49/U3 HC-50/U3
1.5 ~ 1.99	Fundamental	700			
2.0 ~ 2.99	Fundamental	500			600
3.0 ~ 3.19	Fundamental	300			400
3.2 ~ 3.99	Fundamental	150			200
4.0 ~ 4.49	Fundamental	90			150
4.5 ~ 4.99	Fundamental	70		100	80
5.0 ~ 6.99	Fundamental	50		60	60
7.0 ~ 9.99	Fundamental	35		40	40
10.0 ~ 30.0	Fundamental	25	35	25	25
20.0 ~ 24.99	Third Overtone	45		50	50
25.0 ~ 90.0	Third Overtone	40	50	40	40
70.0 ~ 160.0	Fifth Overtone	70	70	70	70

● **Frequency Range & ESR (Unit: Ohm)**

Frequency (MHz)	Vibration Mode	LP Series
3.2 ~ 3.79	Fundamental	180
3.8 ~ 4.49	Fundamental	150
4.5 ~ 5.99	Fundamental	120
6.0 ~ 7.99	Fundamental	100
8.0 ~ 9.99	Fundamental	80
10.0 ~ 11.9	Fundamental	70
12.0 ~ 15.9	Fundamental	60
16.0 ~ 19.9	Fundamental	50
20.0 ~ 25.9	Fundamental	40
26.0 ~ 39.9	Third Overtone	100
40.0 ~ 79.9	Third Overtone	80
80.0 ~ 100.0	Third Overtone	100

● **Frequency Range & ESR (Unit: Ohm)**

Frequency (MHz)	Vibration Mode	UM-1 UM-1 Slim	UM-5 UM-4
3.5 ~ 3.9	Fundamental	200	
4.0 ~ 4.99	Fundamental	150	
5.0 ~ 9.9	Fundamental	60	
10.0 ~ 14.9	Fundamental	40	60
15.0 ~ 50.0	Fundamental	30	35
30.0 ~ 49.9	Third Overtone	45	50
50.0 ~ 100.0	Third Overtone	60	60
75.0 ~ 160.0	Fifth Overtone	80	90

● **Dimension (unit: mm)**

HC49U

HOLDER	H
HC49U	13.0
HC49U1	9.5
HC49U2	11.0
HC49U3	11.4

HC50U

HOLDER	H
HC50U	13.1
HC50U1	9.5
HC50U2	11.0
HC50U3	11.4

HC49S-2.0,2.5,3.5

HOLDER	H
HC49S-2.2	2.2
HC49S-2.5	2.5
HC49S-3.5	3.5

UM-1 Slim

HOLDER	H
UM-1	8.2
UM-4	4.6
UM-5	6.0

UM-1, UM-4, UM-5

CRYSTAL UNITS (DIP TYPE)

● Tape Specification

Item 1:

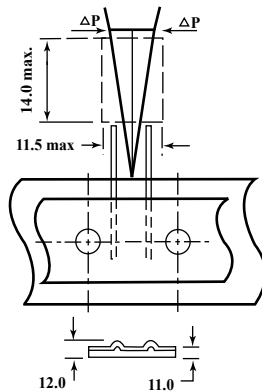
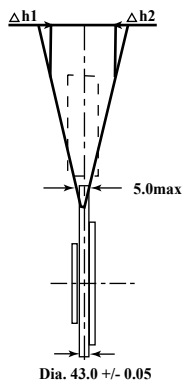
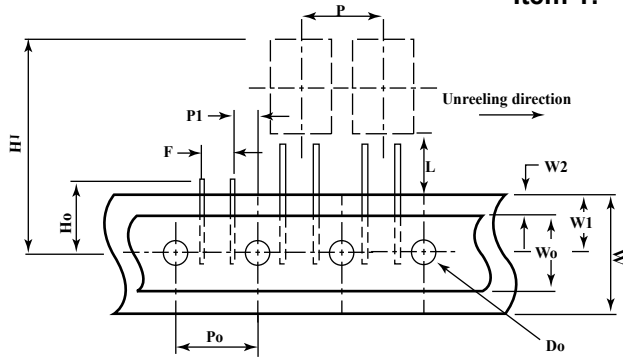

Symbol	Dimension Tolerance (mm)	
P	12.7+/-1.0	
Po	12.7+/-0.3	
P1	3.85+/-0.7	
F	5.0+/-0.8	
W	18.0+1.0/-0.5	
Wo	12.5 or more	
W1	9.0+0.75/-0.5	
W2	3.0 or less	
Do	4.0+/-0.2	
L	9.5 or more	
t1	0.6+/-0.3	
t2	1.5 or less	
Δ h1	2.0 or less	
Δ h2	2.0 or less	
Δ P	2.0 or less	
Ho		4.0+/- 0.2
H1	34.46 or less	xs;24.86

Item 2:

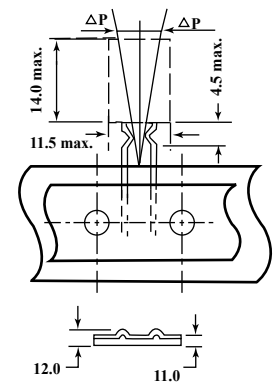
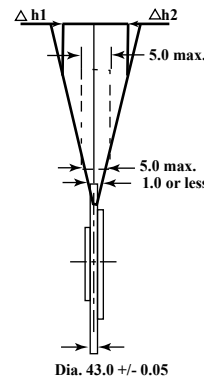
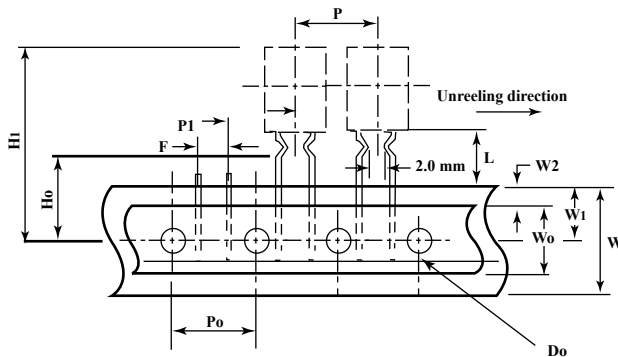

● Reel Specification

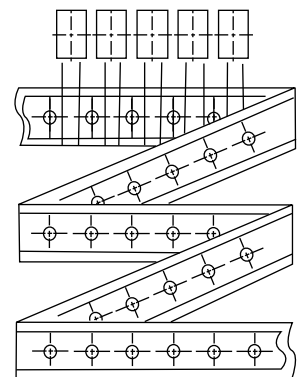
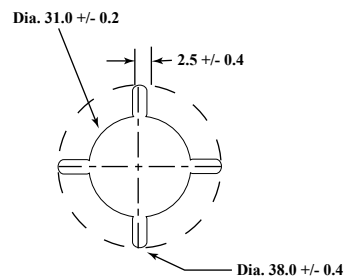
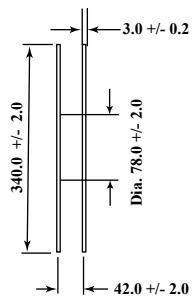
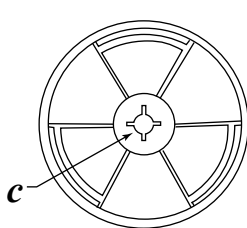

● C Enlarge

● Tape Arrange



● Application

Radio Communication, AV Equipment, Office Automation Equipment, Consumer Products...etc

● Specification

Frequency Range	1.5 ~ 160.0 MHz
Vibration Mode	AT Cut: Fundamental, Third, Fifth
Frequency Tolerance at 25°C	+/-10, +/-15, +/-20, +/-30, +/-50 ppm
Shunt Capacitance	7.0pF max. or specified
Load Capacitance	16, 20, 30pF, Series Resonant or specified
Drive Level	10, 100, 300, 1000uW or specified
Insulation Resistance	500M Ohm min. at DC 100V
Aging	+/- 3, 5 ppm per year or specified

● Operating Temperature Range & Frequency Stability

Temp.\ppm	+/-3	+/-5	+/-7.5	+/-10	+/-15	+/-20	+/-30	+/-50
0 ~ +50°C	■ ○	■ ○	■ ○	■ ○*	■ ○*	■ ○*	■ ○*	■ ○*
-10 ~ +60°C	■ ○	■ ○	■ ○	■ ○*	■ ○*	■ ○*	■ ○*	■ ○*
-20 ~ +70°C		■ ○	■ ○	■ ○	■ ○*	■ ○*	■ ○*	■ ○*
-30 ~ +80°C				■ ○	■ ○	■ ○	■ ○*	■ ○*
-40 ~ +90°C					■ ○	■ ○	■ ○	■ ○*

HC49U & 50U Series : ○
 HC49S Series : *
 UM Series : ■

● Frequency Range & Equivalent Series Resistance (Unit: Ohm)

Frequency (MHz)	Vibration Mode	HC-49/U HC-50/U	HC-49/U1 HC-50/U1	HC-49/U2 HC-50/U2	HC-49/U3 HC-50/U3
1.5 ~ 1.99	Fundamental	700			
2.0 ~ 2.99	Fundamental	500			600
3.0 ~ 3.19	Fundamental	300			400
3.2 ~ 3.99	Fundamental	150			200
4.0 ~ 4.49	Fundamental	90			150
4.5 ~ 4.99	Fundamental	70		100	80
5.0 ~ 6.99	Fundamental	50		60	60
7.0 ~ 9.99	Fundamental	35		40	40
10.0 ~ 30.0	Fundamental	25	35	25	25
20.0 ~ 24.99	Third Overtone	45		50	50
25.0 ~ 90.0	Third Overtone	40	50	40	40

● Frequency Range & ESR (Unit: Ohm)

Frequency (MHz)	Vibration Mode	LP Series
3.2 ~ 3.79	Fundamental	180
3.8 ~ 4.49	Fundamental	150
4.5 ~ 5.99	Fundamental	120
6.0 ~ 7.99	Fundamental	100
8.0 ~ 9.99	Fundamental	80
10.0 ~ 11.9	Fundamental	70
12.0 ~ 15.9	Fundamental	60
16.0 ~ 19.9	Fundamental	50
20.0 ~ 25.9	Fundamental	40
26.0 ~ 39.9	Third Overtone	100
40.0 ~ 59.9	Third Overtone	80
60.0 ~ 79.9	Third Overtone	60
80.0 ~ 100.0	Third Overtone	60

● Frequency Range & ESR (Unit: Ohm)

Frequency (MHz)	Vibration Mode	UM-1 UM-1 Slim	UM-5 UM-4
3.5 ~ 3.9	Fundamental	200	
4.0 ~ 4.99	Fundamental	150	
5.0 ~ 9.9	Fundamental	60	
10.0 ~ 14.9	Fundamental	40	60
15.0 ~ 50.0	Fundamental	30	35
30.0 ~ 49.9	Third Overtone	45	50
50.0 ~ 100.0	Third Overtone	60	60
75.0 ~ 160.0	Third Overtone	80	90

● Dimension (unit: mm)

HC49U (SMD)



HOLDER	H	L
HC49U	13.1	17.06
HC49U1	9.5	13.46
HC49U2	11.0	14.96
HC49U3	11.4	15.36

SMD49S-3.0S,3.5S,5.0S (HC49S SMD Type)



HOLDER	H
SMD49-3.0S	3.0
SMD49-3.5S	3.5
SMD49-5.0S	5.0

UM-1S, UM-4S, UM-5S (SMD)



HOLDER	H	L
UM-1S	7.7	11.7
UM-4S	4.6	8.6
UM-5S	5.9	9.9

CRYSTAL UNITS (DIP TYPE)



● Tape Specification Item 1 : (49U, SMD49S, UM-1)



Symbol	Dimension Tolerance (mm)		
	49U	SMD49S	UM-1
W	32.0+/-0.3	24.0+/-0.3	24.0+/-0.3
W ₀	14.2+/-0.1	11.5+/-0.1	11.5+/-0.1
W ₁	18.0+/-0.2	13.0+/-0.1	13.9+/-0.1
Lo	11.2+/-0.1	5.1+/-0.1	8.7+/-0.1
L1	16.0+/-0.1	12.0+/-0.1	12.0+/-0.1
Ho	0.4+/-0.05	0.4+/-0.05	0.3+/-0.05
H1	4.8+/-0.1	2.0+/-0.01	2.2+/-0.1
Dia.Do	2.0+/-0.1	2.0+/-0.1	2.2+/-0.1

Item 2 : (UM-4, UM -5)



Symbol	Dimension Tolerance (mm)	
	UM-5	UM-4
W	24.0+/-0.3	16.0+/-0.3
W ₀	11.5+/-0.1	7.5+/-0.1
W ₁	11.4+/-0.1	8.9+/-0.1
W ₂	8.7+/-0.1	6.7+/-0.1
L ₀	8.4+/-0.1	8.3+/-0.1
L ₁	12.0+/-0.1	12.0+/-0.1
H ₀	0.4+/-0.05	0.4+/-0.05
H ₁	3.7+/-0.1	3.9+/-0.1
Dia.Do	2.0+/-0.1	1.6+/-0.1

● Reel Specification

C ENLARGE



Dia D	Material
300	Paper-Machine
350	Plastics

● Solder Reflow Diagram

