

1MBH15D-060

Molded IGBT

600V / 15A Molded Package

■ Outline drawings, mm TO-3PL

■ Features

- Small molded package
- Low power loss
- Soft switching with low switching surge and noise
- High reliability, high ruggedness (RBSOA, SCSOA etc.)
- Comprehensive line-up

■ Applications

- Inverter for Motor drive
- AC and DC Servo drive amplifier
- Uninterruptible power supply

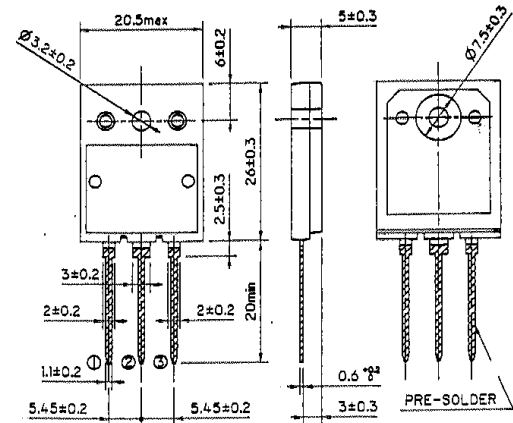

CONNECTION



■ Maximum ratings and characteristics

● Absolute maximum ratings (Tc=25°C)

Item	Symbol	Rating	Unit		
Collector-Emitter voltage	V _{CEs}	600	V		
Gate-Emitter voltage	V _{GES}	±20	V		
Collector current	DC	T _c =25°C	I _{c25}	37	A
		T _c =110°C	I _{c110}	15	A
	1ms	T _c =25°C	I _{cp}	132	A
Max. power dissipation (IGBT)	P _c	140	W		
Max. power dissipation (FWD)	P _c	75	W		
Operating temperature	T _j	+150	°C		
Storage temperature	T _{stg}	-40 to +150	°C		
Screw torque	-	70	N·m		

■ Equivalent Circuit Schematic

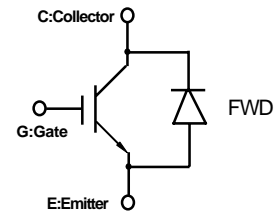

● Electrical characteristics (at Tc=25°C unless otherwise specified)

Item	Symbol	Characteristics			Conditions	Unit		
		Min.	Typ.	Max.				
Zero gate voltage collector current	I _{CEs}	-	-	1.0	V _{GE} =0V, V _{CE} =600V	mA		
Gate-Emitter leakage current	I _{GES}	-	-	20	V _{CE} =0V, V _{GE} =±20V	µA		
Gate-Emitter threshold voltage	V _{GE(th)}	5.5	-	8.5	V _{CE} =20V, I _c =15mA	V		
Collector-Emitter saturation voltage	V _{CE(sat)}	-	-	3.0	V _{GE} =15V, I _c =15A	V		
Input capacitance	C _{ies}	-	1000	-	V _{GE} =0V	pF		
Output capacitance	C _{oes}	-	200	-	V _{CE} =10V			
Reverse transfer capacitance	C _{res}	-	40	-	f=1MHz			
Switching Time	Turn-on time	t _{on}	-	-	1.2	V _{CC} =300V, I _c =15A	µs	
		t _r	-	-	0.6	V _{GE} =±15V		
	Turn-off time	t _{off}	-	-	1.0	R _G =160 ohm		
		t _f	-	-	0.35	(Half Bridge)		
	Turn-on time	t _{on}	-	0.16	-	V _{CC} =300V, I _c =15A		µs
		t _r	-	0.11	-	V _{GE} =+15V		
Turn-off time	t _{off}	-	0.30	-	R _G =16 ohm			
	t _f	-	-	0.35	(Half Bridge)			
FWD forward on voltage	V _F	-	-	3.0	I _F =15A	V		
Reverse recovery time	t _{rr}	-	-	0.3	I _F =15A, V _{GE} =-10V, V _R =200V, di/dt=100A/µs	µs		

● Thermal resistance characteristics

Item	Symbol	Characteristics			Conditions	Unit
		Min.	Typ.	Max.		
Thermal resistance	R _{th(j-c)}	-	-	0.89	IGBT	°C/W
	R _{th(j-c)}	-	-	1.66	FWD	°C/W

Characteristics

Collector current vs. Collector-Emitter voltage
T_j=25°C

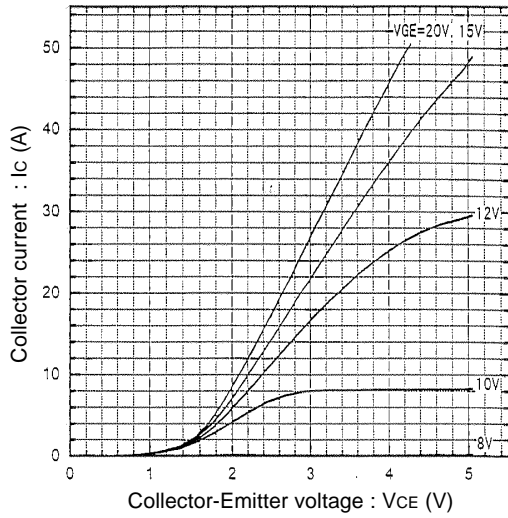

Collector current vs. Collector-Emitter voltage
T_j=125°C

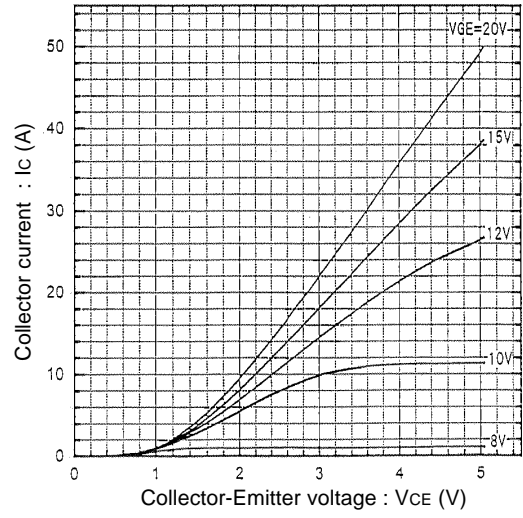

Collector-Emitter voltage vs. Gate-Emitter voltage
T_j=25°C

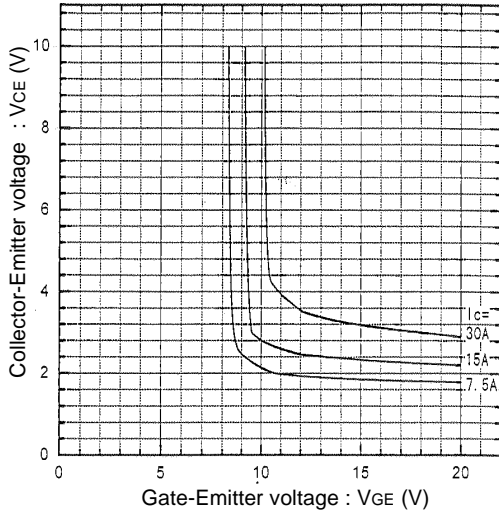

Collector-Emitter voltage vs. Gate-Emitter voltage
T_j=125°C

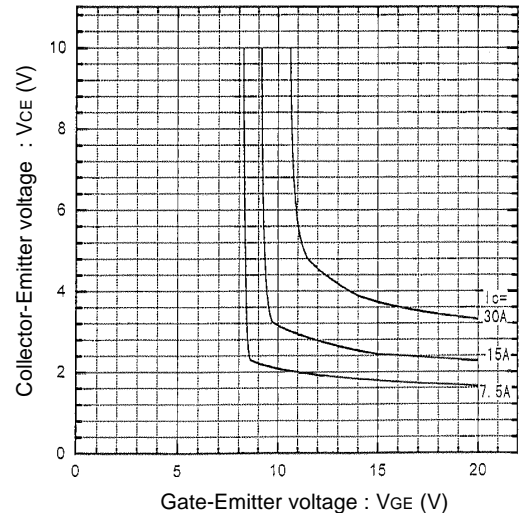

Switching time vs. Collector current
V_{CC}=300V, R_G=16Ω, V_{GE}=±15V, T_j=25°C

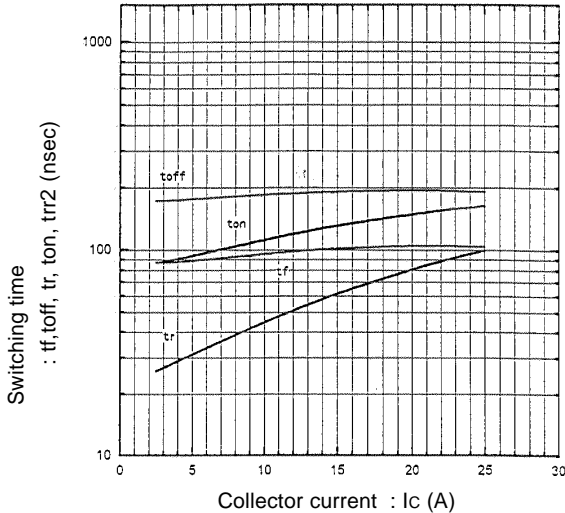

Switching time vs. Collector current
V_{CC}=300V, R_G=16Ω, V_{GE}=±15V, T_j=125°C

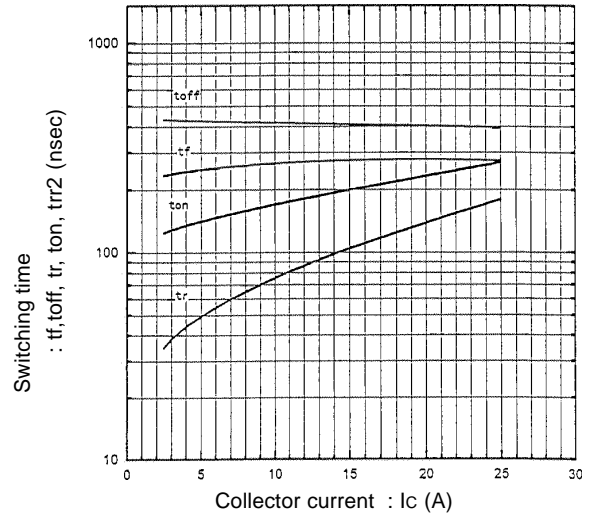

Characteristics

Switching time vs. R_G
 $V_{CC}=300V, I_C=15A, V_{GE}=\pm 15V, T_J=25^\circ C$

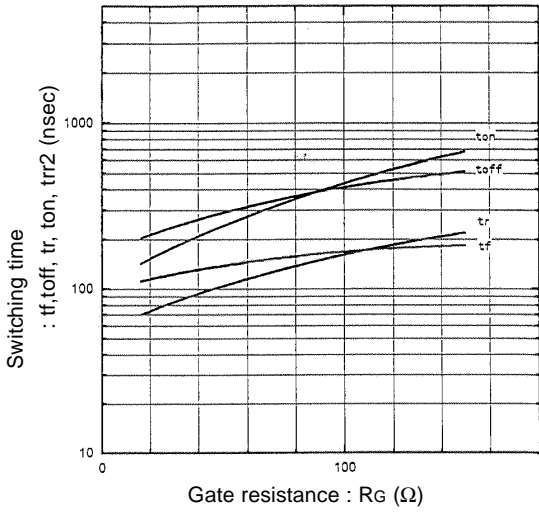

Switching time vs. R_G
 $V_{CC}=300V, I_C=15A, V_{GE}=\pm 15V, T_J=125^\circ C$

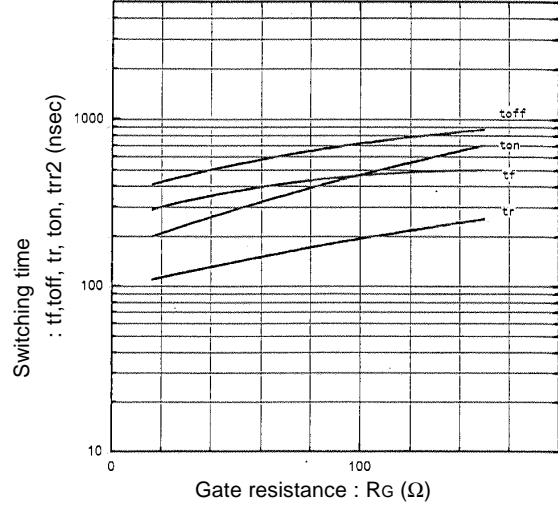

Dynamic input characteristics
 $T_J=25^\circ C$

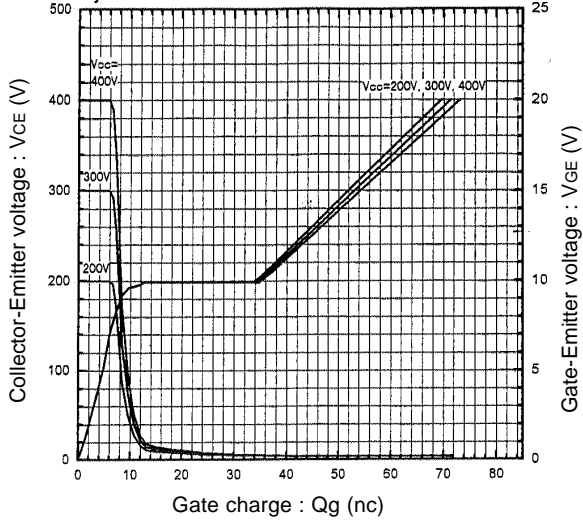

Capacitance vs. Collector-Emitter voltage
 $T_J=25^\circ C$

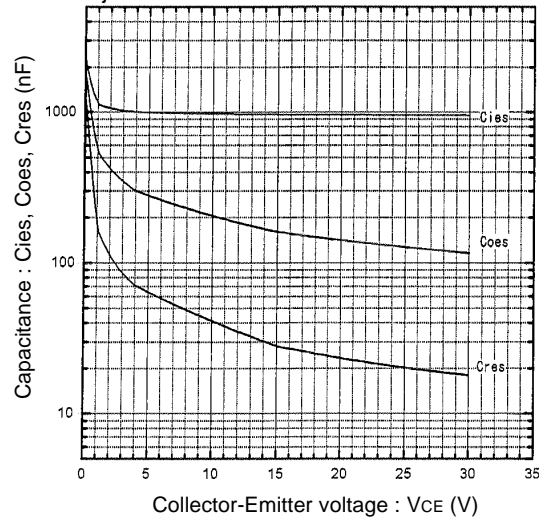

Reverse Biased Safe Operating Area
 $+V_{GE}=15V, -V_{GE}\leq 15V, T_J\leq 125^\circ C, R_G\geq 16\Omega$

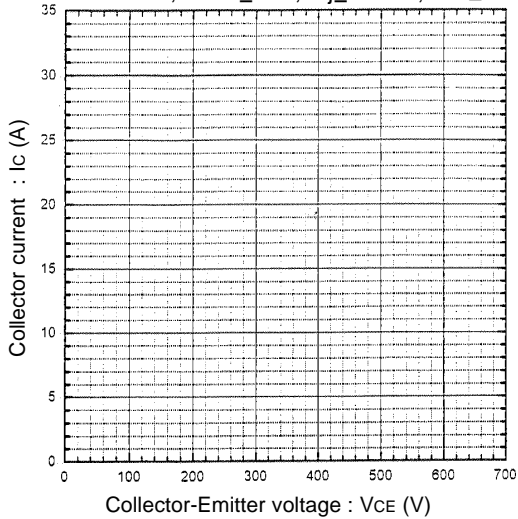

Typical short circuit capability
 $V_{CC}=400V, R_G=16\Omega, T_J=125^\circ C,$

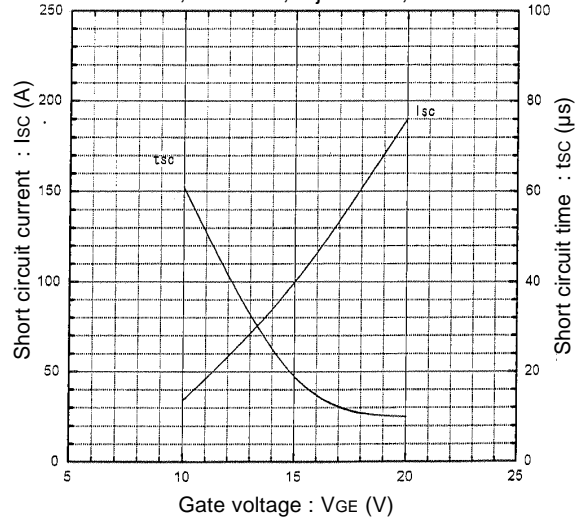

■ Characteristics

Reverse recovery time vs. Forward current
VR=200V, -di/dt=100A/μsec

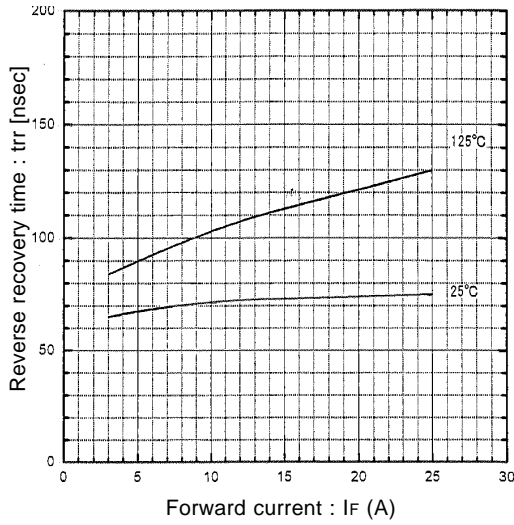

Reverse recovery current vs. Forward current
VR=200V, -di/dt=100A/μsec

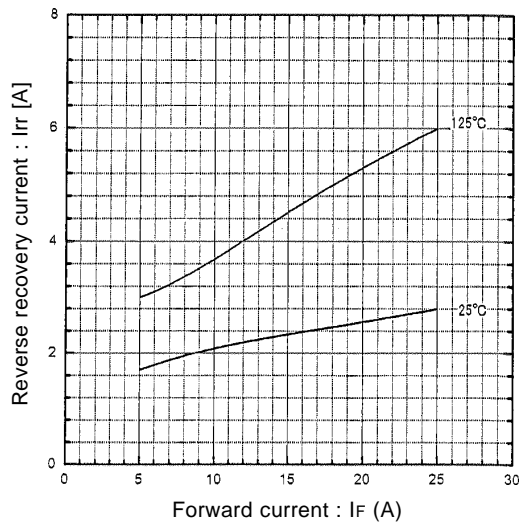

Forward voltage vs. Forward current

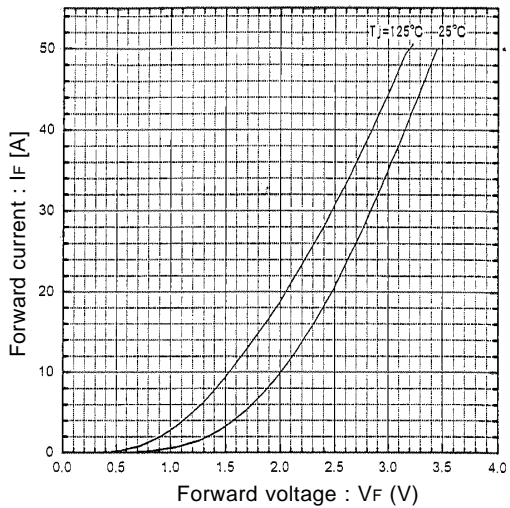

Reverse recovery characteristics vs. -di/dt
IF=15A, Tj=125°C

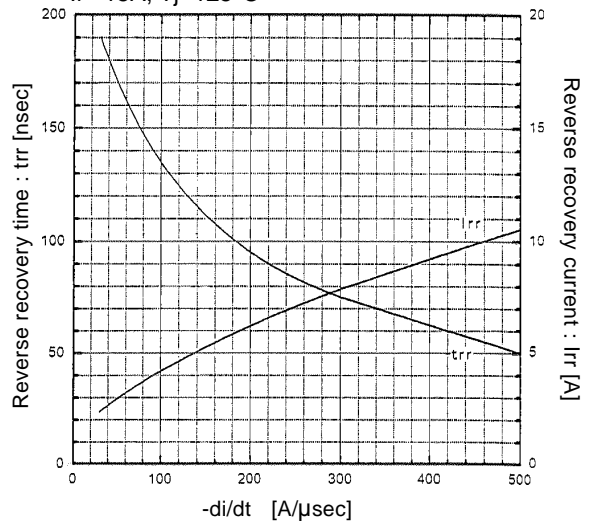

Transient thermal resistance

