



20TQ...
20TQ...S

SCHOTTKY RECTIFIER

20 Amp

$I_{F(AV)} = 19\text{Amp}$
 $V_R = 35 \text{ to } 45\text{V}$

Major Ratings and Characteristics

Characteristics	20TQ	Units
$I_{F(AV)}$ Rectangular waveform	20	A
V_{RRM} range	35 to 45	V
I_{FSM} @tp = 5 μ s sine	1800	A
V_F @20 Apk, $T_J = 125^\circ\text{C}$	0.51	V
T_J range	-55 to 150	$^\circ\text{C}$

Description/ Features

The 20TQ Schottky rectifier series has been optimized for very low forward voltage drop, with moderate leakage. The proprietary barrier technology allows for reliable operation up to 150° C junction temperature. Typical applications are in switching power supplies, converters, free-wheeling diodes, and reverse battery protection.

- 150° C T_J operation
- High purity, high temperature epoxy encapsulation for enhanced mechanical strength and moisture resistance
- Low forward voltage drop
- High frequency operation
- Guard ring for enhanced ruggedness and long term reliability

Case Styles

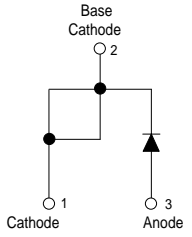
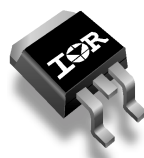
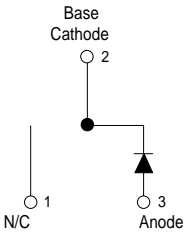
<p>20TQ...</p>  <p>Base Cathode 2</p>  <p>1 Cathode 3 Anode</p> <p>TO-220AC</p>	<p>20TQ... S</p>  <p>Base Cathode 2</p>  <p>1 N/C 3 Anode</p> <p>D²PAK</p>
---	---

20TQ... Series

Bulletin PD-20241 rev. B 12/01

International
IR Rectifier

Voltage Ratings

Part number	20TQ035	20TQ040	20TQ045
V_R Max. DC Reverse Voltage (V)	35	40	45
V_{RWM} Max. Working Peak Reverse Voltage (V)			

Absolute Maximum Ratings

Parameters	20TQ	Units	Conditions
$I_{F(AV)}$ Max. Average Forward Current * See Fig. 5	20	A	50% duty cycle @ $T_C = 116^\circ\text{C}$, rectangular wave form
I_{FSM} Max. Peak One Cycle Non-Repetitive Surge Current * See Fig. 7	1800	A	Following any rated load condition and with rated V_{RRM} applied
	400		
E_{AS} Non-Repetitive Avalanche Energy	27	mJ	$T_J = 25^\circ\text{C}$, $I_{AS} = 4$ Amps, $L = 3.4$ mH
I_{AR} Repetitive Avalanche Current	4	A	Current decaying linearly to zero in 1 μsec Frequency limited by T_J max. $V_A = 1.5 \times V_R$ typical

Electrical Specifications

Parameters	20TQ	Units	Conditions
V_{FM} Max. Forward Voltage Drop (1) * See Fig. 1	0.57	V	@ 20A
	0.73	V	@ 40A
	0.51	V	@ 20A
	0.67	V	@ 40A
I_{RM} Max. Reverse Leakage Current (1) * See Fig. 2	2.7	mA	$T_J = 25^\circ\text{C}$
	105	mA	$T_J = 125^\circ\text{C}$
C_T Max. Junction Capacitance	1400	pF	$V_R = 5V_{DC}$, (test signal range 100Khz to 1Mhz) 25°C
L_S Typical Series Inductance	8.0	nH	Measured lead to lead 5mm from package body
dv/dt Max. Voltage Rate of Change (Rated V_R)	10000	V/ μs	

(1) Pulse Width < 300 μs , Duty Cycle < 2%

Thermal-Mechanical Specifications

Parameters	20TQ	Units	Conditions
T_J Max. Junction Temperature Range	-55 to 150	$^\circ\text{C}$	
T_{stg} Max. Storage Temperature Range	-55 to 150	$^\circ\text{C}$	
R_{thJC} Max. Thermal Resistance Junction to Case	1.50	$^\circ\text{C/W}$	DC operation * See Fig. 4
R_{thCS} Typical Thermal Resistance, Case to Heatsink	0.50	$^\circ\text{C/W}$	Mounting surface, smooth and greased
wt Approximate Weight	2 (0.07)	g (oz.)	
T Mounting Torque	Min.	6 (5)	Kg-cm (lbf-in)
	Max.	12 (10)	

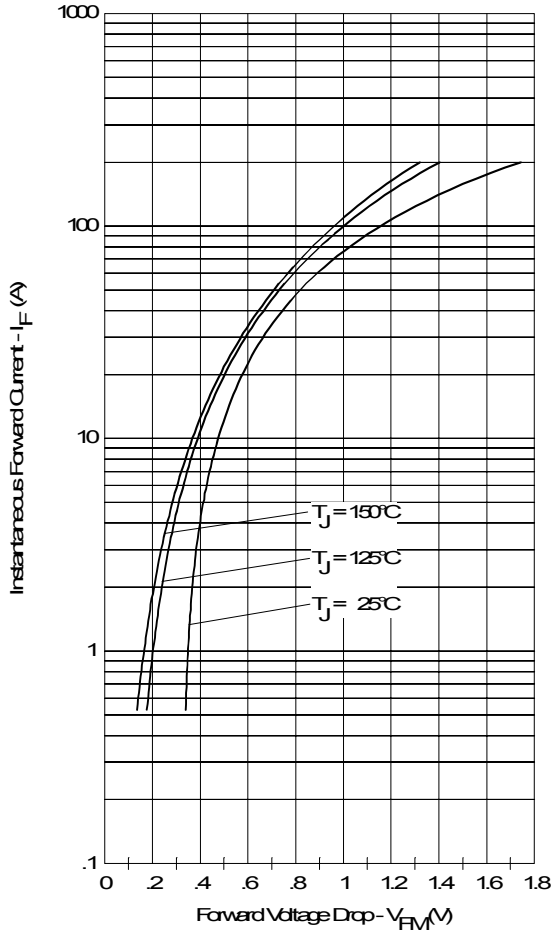

Fig. 1 - Maximum Forward Voltage Drop Characteristics

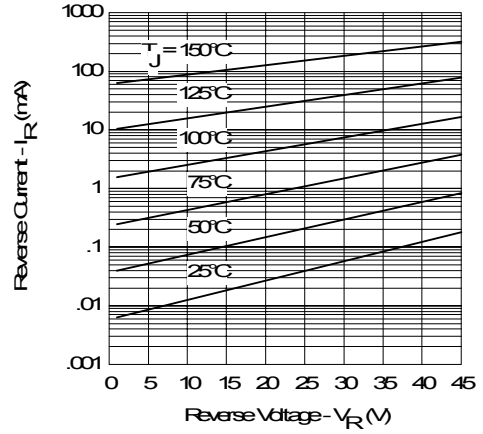

Fig. 2 - Typical Values of Reverse Current Vs. Reverse Voltage

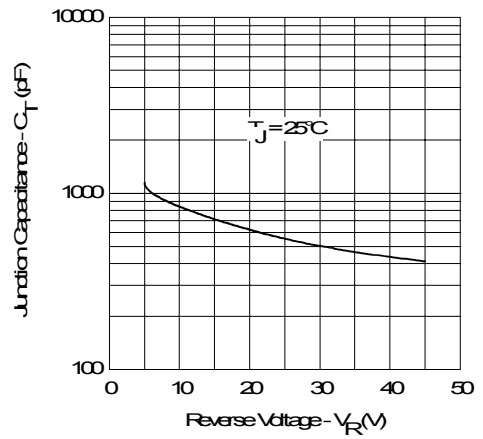

Fig. 3 - Typical Junction Capacitance Vs. Reverse Voltage

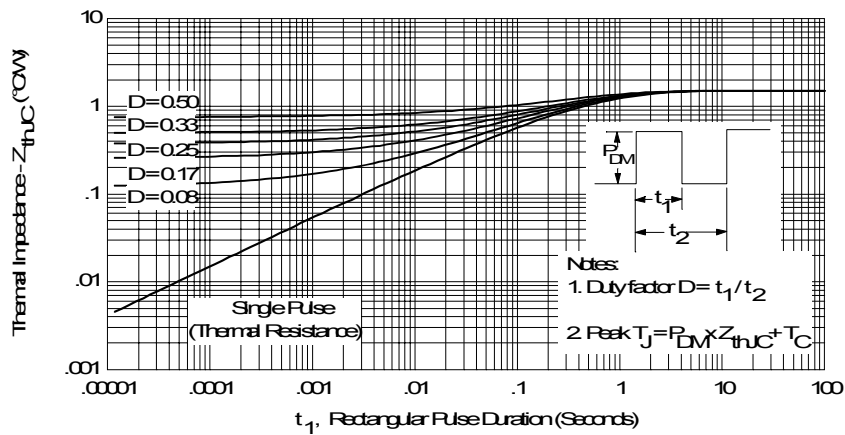

Fig. 4 - Maximum Thermal Impedance Z_{thJC} Characteristics

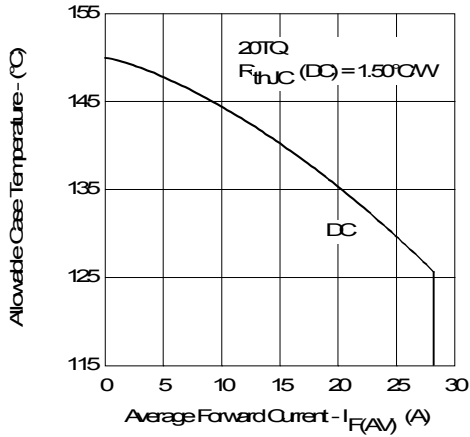

Fig. 5 - Maximum Allowable Case Temperature Vs. Average Forward Current

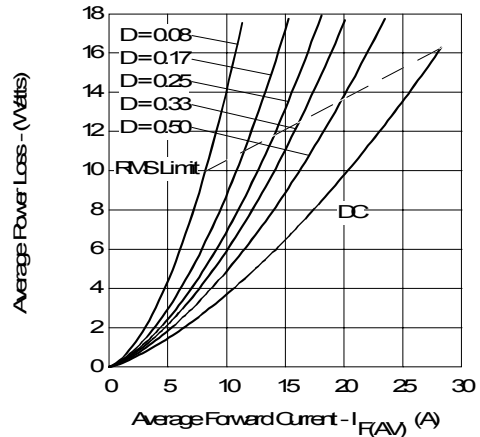

Fig. 6 - Forward Power Loss Characteristics

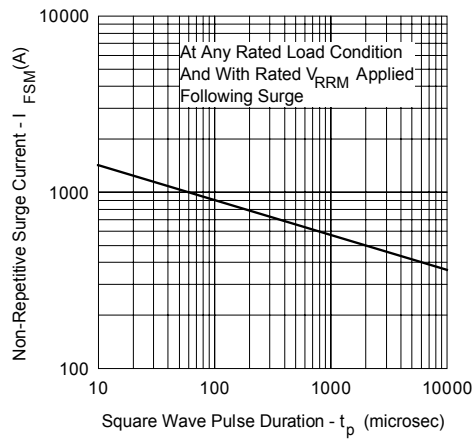

Fig. 7 - Maximum Non-Repetitive Surge Current

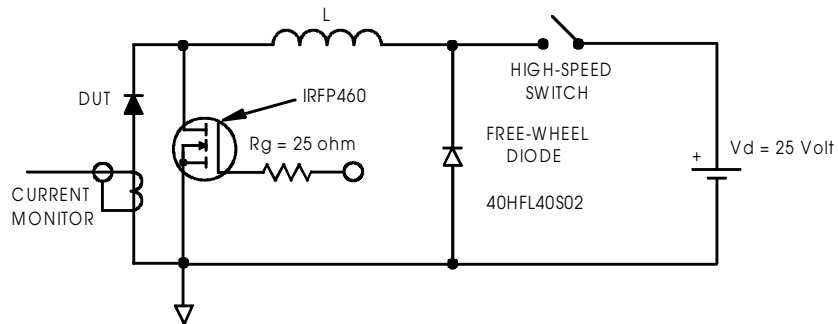
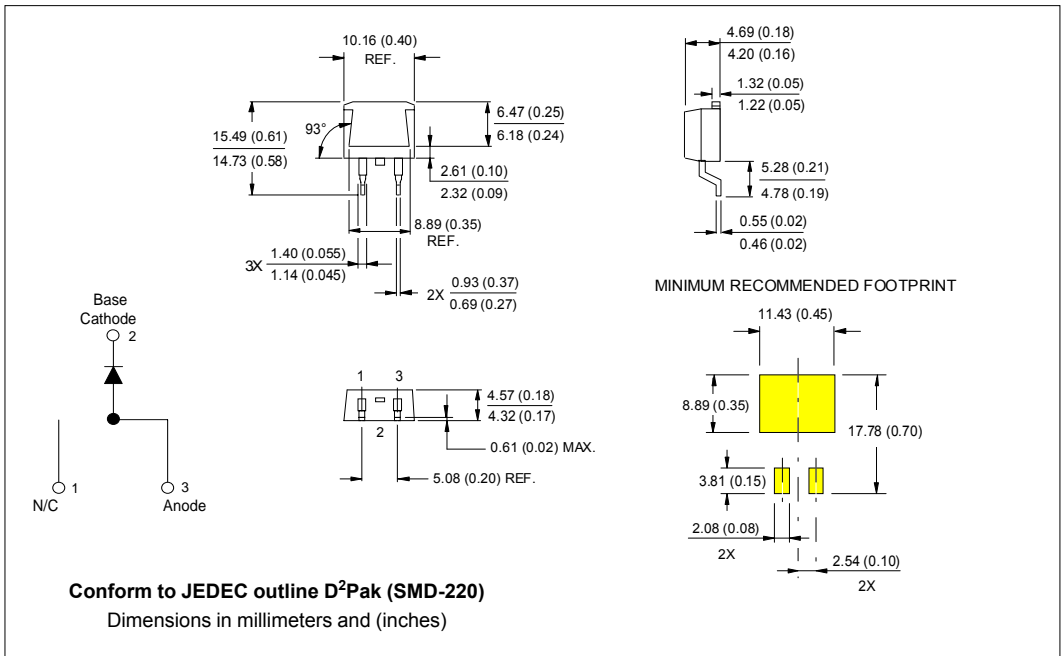
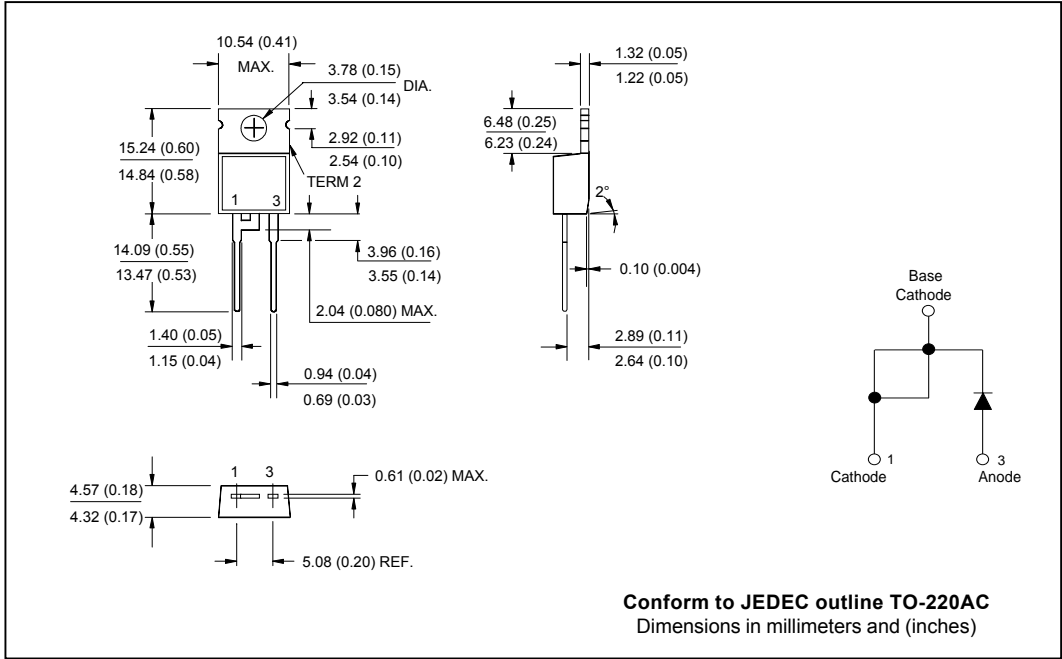
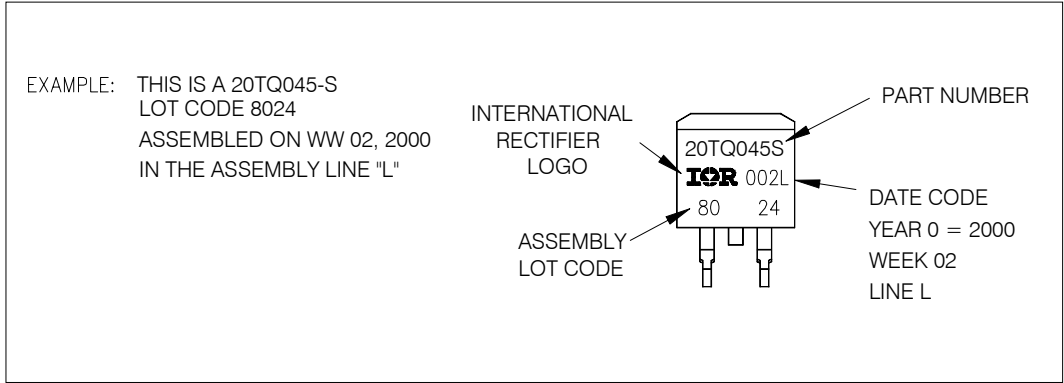

Fig. 8 - Unclamped Inductive Test Circuit

Outline Table



Marking Information



Tape & Reel Information

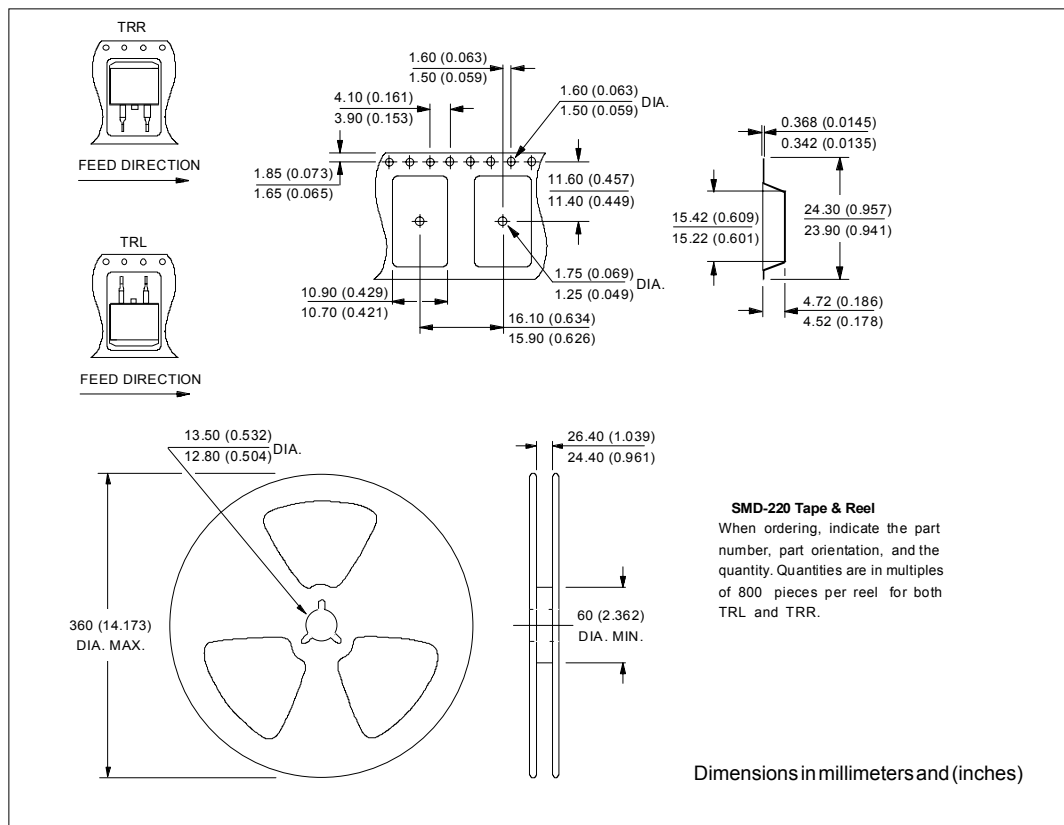

Ordering Information Table

Device Code

20	T	Q	045	S
①	②	③	④	⑤

1	-	Essential Part Number	
2	-	T = TO-220	
3	-	Q = Schottky Q Series	
4	-	Voltage Rating	035 = 35V
5	-	S = D ² Pak	040 = 40V
			045 = 45V

Data and specifications subject to change without notice.
 This product has been designed and qualified for Industrial Level.
 Qualification Standards can be found on IR's Web site.

This datasheet has been download from:

www.datasheetcatalog.com

Datasheets for electronics components.