

Silicon Controlled Rectifiers

Reverse Blocking Thyristors

**MCR16
SERIES***

*Motorola preferred devices

SCRs
16 AMPERES RMS
400 thru 800
VOLTS

Designed primarily for half-wave ac control applications, such as motor controls, heating controls, and power supplies; or wherever half-wave, silicon gate-controlled devices are needed.

- Blocking Voltage to 800 Volts
- On-State Current Rating of 16 Amperes RMS
- High Surge Current Capability — 160 Amperes
- Industry Standard TO-220AB Package for Ease of Design
- Glass Passivated Junctions for Reliability and Uniformity

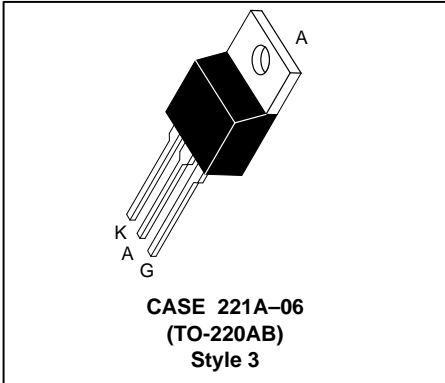

MAXIMUM RATINGS ($T_J = 25^\circ\text{C}$ unless otherwise noted)

Parameter	Symbol	Value	Unit
Peak Repetitive Off-State Voltage (1) Peak Repetitive Reverse Voltage ($T_J = -40$ to 125°C)	V_{DRM} V_{RRM}	400 600 800	Volts
On-State RMS Current (All Conduction Angles)	$I_T(\text{RMS})$	16	A
Peak Non-repetitive Surge Current (One Half Cycle, 60 Hz, $T_J = 125^\circ\text{C}$)	I_{TSM}	160	A
Circuit Fusing Consideration ($t = 8.3$ ms)	I^2t	106	A^2sec
Peak Gate Power (Pulse Width ≤ 1.0 μs , $T_C = 80^\circ\text{C}$)	P_{GM}	5.0	Watts
Average Gate Power ($t = 8.3$ ms, $T_C = 80^\circ\text{C}$)	$P_{G(AV)}$	0.5	Watts
Peak Gate Current (Pulse Width ≤ 1.0 μs , $T_C = 80^\circ\text{C}$)	I_{GM}	2.0	A
Operating Junction Temperature Range	T_J	-40 to +125	$^\circ\text{C}$
Storage Temperature Range	T_{stg}	-40 to +150	$^\circ\text{C}$

THERMAL CHARACTERISTICS

Thermal Resistance — Junction to Case — Junction to Ambient	$R_{\theta JC}$ $R_{\theta JA}$	1.5 62.5	$^\circ\text{C}/\text{W}$
Maximum Lead Temperature for Soldering Purposes 1/8" from Case for 10 Seconds	T_L	260	$^\circ\text{C}$

(1) V_{DRM} and V_{RRM} for all types can be applied on a continuous basis. Ratings apply for zero or negative gate voltage; positive gate voltage shall not be applied concurrent with negative potential on the anode. Blocking voltages shall not be tested with a constant current source such that the voltage ratings of the devices are exceeded.

Preferred devices are Motorola recommended choices for future use and best overall value.

REV 1

MCR16 SERIES

ELECTRICAL CHARACTERISTICS (T_J = 25°C unless otherwise noted)

Characteristic	Symbol	Min	Typ	Max	Unit
OFF CHARACTERISTICS					
Peak Forward Blocking Current Peak Reverse Blocking Current (V _{AK} = Rated V _{DRM} or V _{RRM} , Gate Open)	T _J = 25°C T _J = 125°C I _{DRM} I _{RRM}	— —	— —	0.01 2.0	mA
ON CHARACTERISTICS					
Peak On-State Voltage* (I _{TM} = 32 A)	V _{TM}	—	—	1.7	Volts
Gate Trigger Current (Continuous dc) (V _D = 12 V, R _L = 100 Ω)	I _{GT}	2.0	8.0	20	mA
Gate Trigger Voltage (Continuous dc) (V _D = 12 V, R _L = 100 Ω)	V _{GT}	0.5	0.65	1.0	Volts
Hold Current (Anode Voltage = 12 V)	I _H	4.0	25	40	mA
DYNAMIC CHARACTERISTICS					
Critical Rate of Rise of Off-State Voltage (V _D = Rated V _{DRM} , Exponential Waveform, Gate Open, T _J = 25°C)	dv/dt	50	200	—	V/μs

*Indicates Pulse Test: Pulse Width ≤ 2.0 ms, Duty Cycle ≤ 2%.

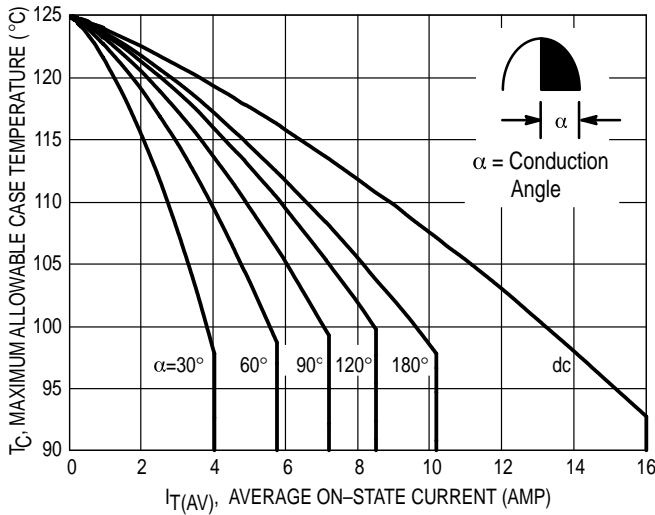

Figure 1. Average Current Derating

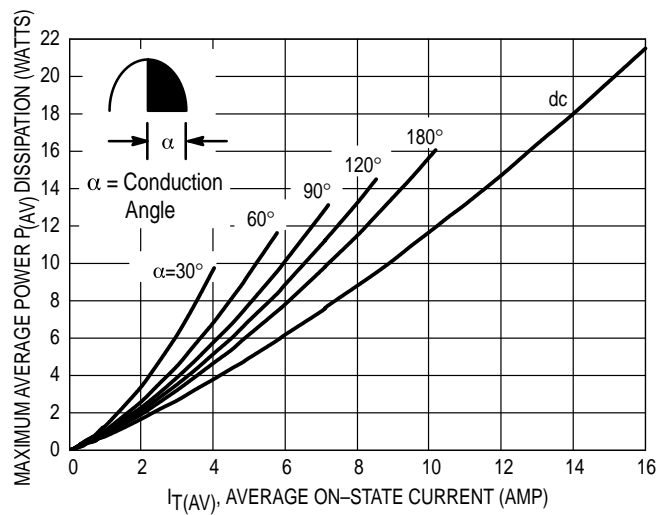

Figure 2. Maximum On-State Power Dissipation

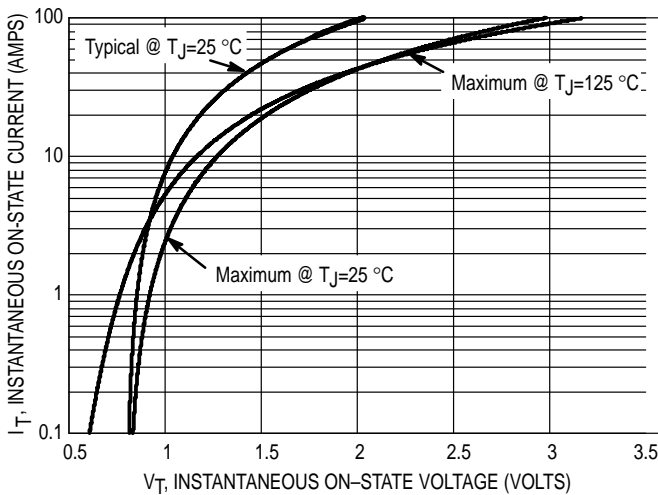

Figure 3. On-State Characteristics

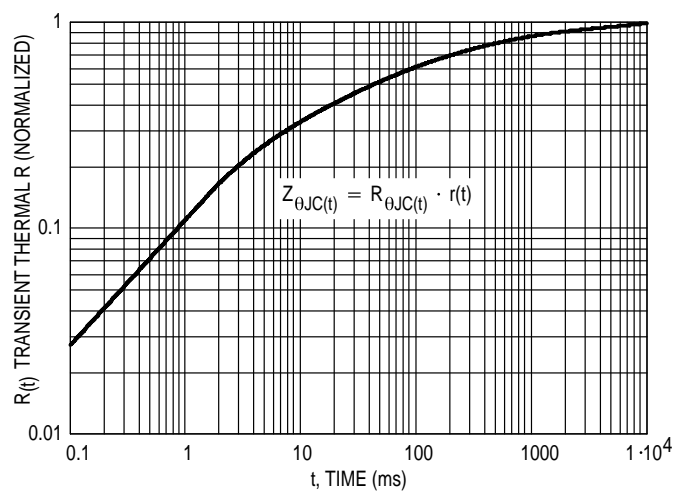

Figure 4. Transient Thermal Response

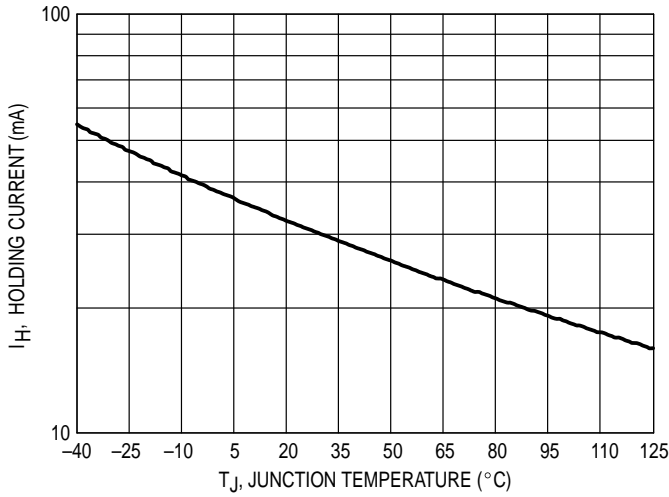

Figure 5. Typical Holding Current Versus Junction Temperature

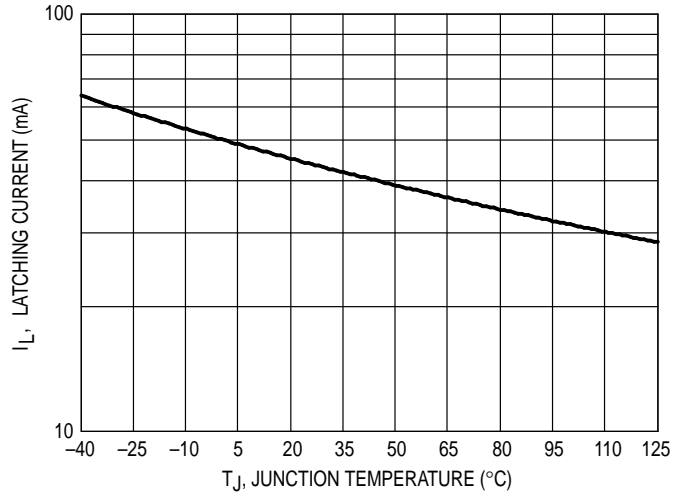

Figure 6. Typical Latching Current Versus Junction Temperature

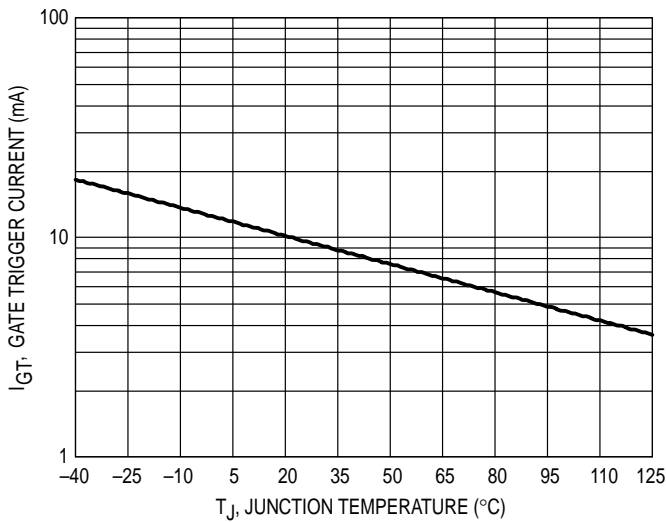

Figure 7. Typical Gate Trigger Current Versus Junction Temperature

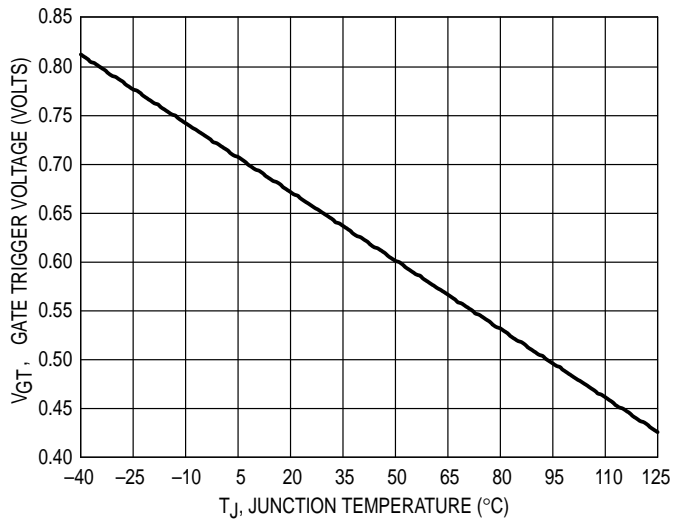

Figure 8. Typical Gate Trigger Voltage Versus Junction Temperature

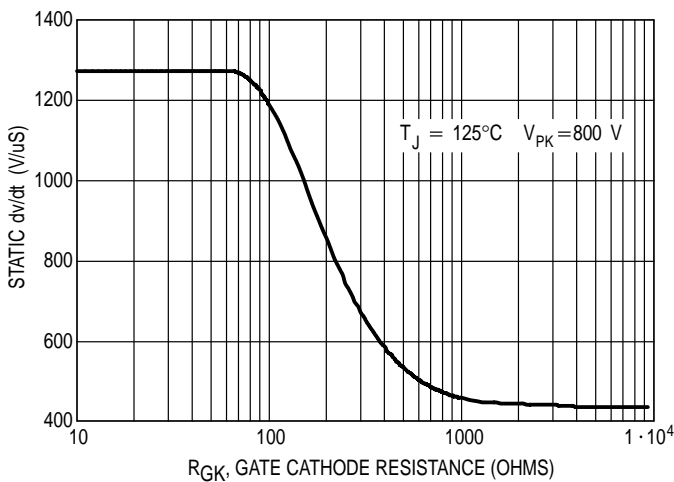

Figure 9. Typical Exponential Static dv/dt Versus Gate Cathode Resistance.

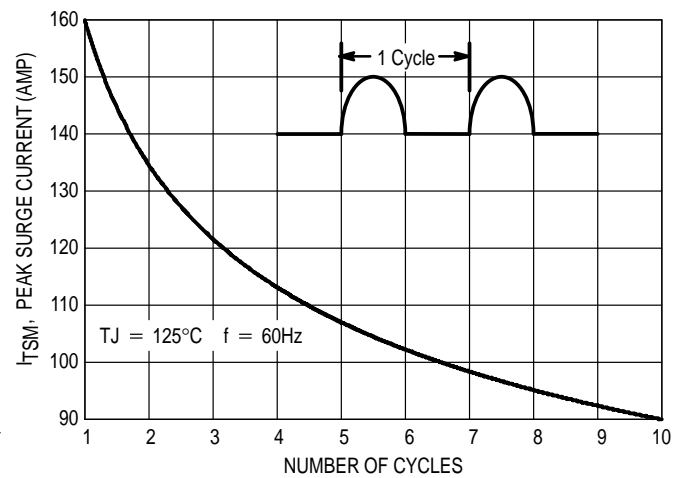
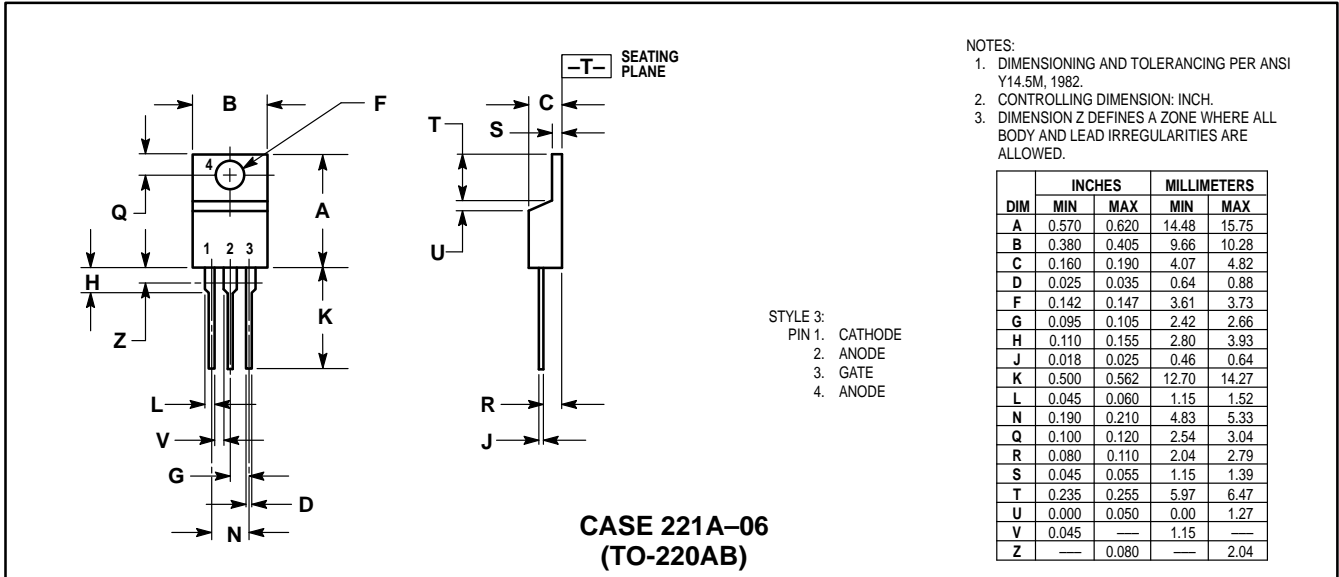

Figure 10. Maximum Non-Repetitive Surge Current

MCR16 SERIES

PACKAGE DIMENSIONS



Motorola reserves the right to make changes without further notice to any products herein. Motorola makes no warranty, representation or guarantee regarding the suitability of its products for any particular purpose, nor does Motorola assume any liability arising out of the application or use of any product or circuit, and specifically disclaims any and all liability, including without limitation consequential or incidental damages. "Typical" parameters can and do vary in different applications. All operating parameters, including "Typicals" must be validated for each customer application by customer's technical experts. Motorola does not convey any license under its patent rights nor the rights of others. Motorola products are not designed, intended, or authorized for use as components in systems intended for surgical implant into the body, or other applications intended to support or sustain life, or for any other application in which the failure of the Motorola product could create a situation where personal injury or death may occur. Should Buyer purchase or use Motorola products for any such unintended or unauthorized application, Buyer shall indemnify and hold Motorola and its officers, employees, subsidiaries, affiliates, and distributors harmless against all claims, costs, damages, and expenses, and reasonable attorney fees arising out of, directly or indirectly, any claim of personal injury or death associated with such unintended or unauthorized use, even if such claim alleges that Motorola was negligent regarding the design or manufacture of the part. Motorola and are registered trademarks of Motorola, Inc. Motorola, Inc. is an Equal Opportunity/Affirmative Action Employer.

Literature Distribution Centers:

USA: Motorola Literature Distribution; P.O. Box 20912; Phoenix, Arizona 85036.
 EUROPE: Motorola Ltd.; European Literature Centre; 88 Tanners Drive, Blakelands, Milton Keynes, MK14 5BP, England.
 JAPAN: Nippon Motorola Ltd.; 4-32-1, Nishi-Gotanda, Shinagawa-ku, Tokyo 141, Japan.
 ASIA PACIFIC: Motorola Semiconductors H.K. Ltd.; Silicon Harbour Center, No. 2 Dai King Street, Tai Po Industrial Estate, Tai Po, N.T., Hong Kong.



This datasheet has been download from:

www.datasheetcatalog.com

Datasheets for electronics components.