

**SANYO**

No.2168B

**L78MR00 Series**

5 to 12V 0.5A 5-Pin  
Voltage Regulators with Reset Function

The L78MR00 series, 500mA general-purpose voltage regulator ICs provide reset output signal for micro computers.

**Features**

- Reset function (power supply voltage monitor : Generates a reset signal at a power-on and temporal power-down).
- Output voltage
 

L78MR05 : 5V	(Reset output	.....	On-chip pull-up resistor)
L78MR06 : 6V	(Reset output	.....	Open collector)
L78MR08 : 8V	(Reset output	.....	Open collector)
L78MR09 : 9V	(Reset output	.....	Open collector)
L78MR12 : 12V	(Reset output	.....	Open collector)
- Output current ..... 500mA
- On-chip ASO protector.
- On-chip thermal protector.
- On-chip over current limiter.
- The use of package TO220-5H facilitates easy mounting and thermal design.
- Delay time ( $t_d$ ) may be set by an external capacitor.

[Common to L78MR00 Series]

Maximum Ratings at  $T_a = 25^\circ\text{C}$

				unit
Maximum Input Voltage	$V_{IN \text{ max}}$		35	V
Reset Pin Supply Voltage	$V_{reset}$		35	V
Allowable Power Dissipation	$P_d \text{ max}$	No fin	1.75	W
		$T_C = 25^\circ\text{C}$	20	W
Operating Temperature	$T_{opr}$		-30 to +80	$^\circ\text{C}$
Storage Temperature	$T_{stg}$		-55 to +150	$^\circ\text{C}$

**Equivalent Circuit Block Diagram**

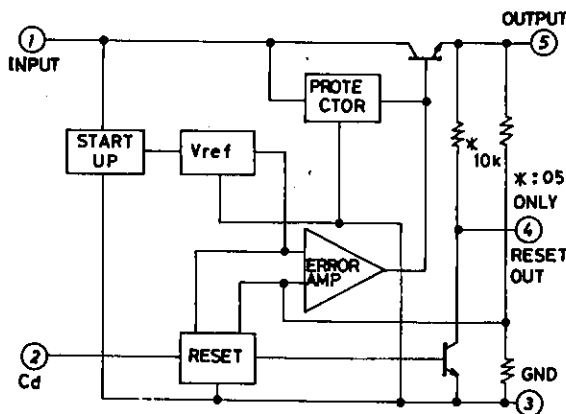

Unit (resistance:  $\Omega$ )

**Package Dimensions**  
(unit: mm)

3079

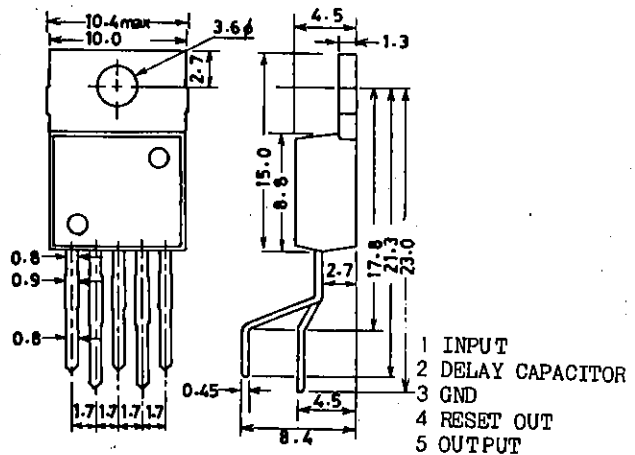

SANYO : TO-220 5H

**SANYO Electric Co., Ltd. Semiconductor Business Headquarters**  
TOKYO OFFICE Tokyo Bldg., 1-10, 1 Chome, Ueno, Taito-ku, TOKYO, 110 JAPAN

## L78MR00 Series

### [L78MR05]

#### Recommended Operating Conditions at $T_a = 25^\circ\text{C}$

Parameter	Symbol	Value	Unit
Input Voltage	$V_{IN}$	7.5 to 20	V
Output Current	$I_o$	5 to 500	mA

#### Operating Characteristics at $T_a = 25^\circ\text{C}$ , $V_{IN} = 10\text{V}$ , $I_o = 0.35\text{A}$ , $C_o = 10\mu\text{F}$

Parameter	Symbol	Conditions	min	typ	max	unit
Output Voltage	$V_{o1}$	$T_j = 25^\circ\text{C}$	4.8	5.0	5.2	V
	$V_{o2}$	$7\text{V} \leq V_{IN} \leq 20\text{V}$ , $5\text{mA} \leq I_o \leq 0.35\text{A}$	4.75		5.25	V
Line Regulation	$\Delta V_o$	LN1 $T_j = 25^\circ\text{C}$ , $7\text{V} \leq V_{IN} \leq 25\text{V}$ , $I_o = 0.2\text{A}$		1.0	100	mV
		LN2 $T_j = 25^\circ\text{C}$ , $8\text{V} \leq V_{IN} \leq 25\text{V}$ , $I_o = 0.2\text{A}$		0.5	50	mV
Load Regulation	$\Delta V_o$	LD1 $T_j = 25^\circ\text{C}$ , $5\text{mA} \leq I_o \leq 0.5\text{A}$		3.0	100	mV
		LD2 $T_j = 25^\circ\text{C}$ , $5\text{mA} \leq I_o \leq 0.2\text{A}$		1.5	50	mV
Current Dissipation	$I_{CC}$	$T_j = 25^\circ\text{C}$	3.4		6.0	mA
Current Dissipation Variation (Line)	$\Delta I_{CC}$	LN $8\text{V} \leq V_{IN} \leq 25\text{V}$ , $I_o \leq 0.2\text{A}$			0.8	mA
		LD $5\text{mA} \leq I_o \leq 0.35\text{A}$			0.5	mA
Output Noise Voltage	$V_{NO}$	$I_o = 5\text{mA}$ , $10\text{Hz} \leq f \leq 100\text{kHz}$		60		$\mu\text{V}$
Ripple Rejection	Rr1	$T_j = 25^\circ\text{C}$ , $f = 120\text{Hz}$ , $8\text{V} \leq V_{IN} \leq 18\text{V}$ , $I_o = 0.1\text{A}$	62	80		dB
	Rr2	$T_j = 25^\circ\text{C}$ , $f = 120\text{Hz}$ , $8\text{V} \leq V_{IN} \leq 18\text{V}$ , $I_o = 0.3\text{A}$	62	77		dB
Dropout Voltage	$V_{drop}$			2.0	2.5	V
Peak Output Current	$I_{OP}$	$T_j = 25^\circ\text{C}$		1.1		A
Short Circuit Current	$I_{OSC}$	$T_j = 25^\circ\text{C}$ , $V_{IN} = 35\text{V}$		0.02		A
Temperature Coefficient of Output Voltage	$\Delta V_o/\Delta T$	$I_o = 5\text{mA}$ , $T_j = 25$ to $125^\circ\text{C}$	-0.3			mV/ $^\circ\text{C}$
'L' Reset Output Voltage	$V_{ORL}$	$V_o \leq 4.5\text{V}$ , $I_o = 5\text{mA}$			0.2	V
Reset Threshold Voltage	$V_{RT}$	$I_o = 5\text{mA}$		$V_o - 0.3V_o - 0.2$		V
Reset Hysteresis Voltage	$V_{RTH}$	$I_o = 5\text{mA}$		100		mV
Reset Output Delay Time	$t_d$	$C_d = 0.1\mu\text{F}$ , $I_o = 5\text{mA}$		10		ms

### [L78MR06]

#### Recommended Operating Conditions at $T_a = 25^\circ\text{C}$

Parameter	Symbol	Value	Unit
Input Voltage	$V_{IN}$	8.5 to 21	V
Output Current	$I_o$	5 to 500	mA
Reset Output Current	$I_{oR}$	$V_o \leq 5.64\text{V}$	20 mA max

#### Operating Characteristics at $T_a = 25^\circ\text{C}$ , $V_{IN} = 11\text{V}$ , $I_o = 0.35\text{A}$ , $C_o = 10\mu\text{F}$

Parameter	Symbol	Conditions	min	typ	max	unit
Output Voltage	$V_{o1}$	$T_j = 25^\circ\text{C}$	5.75	6.0	6.25	V
	$V_{o2}$	$8\text{V} \leq V_{IN} \leq 21\text{V}$ , $5\text{mA} \leq I_o \leq 0.35\text{A}$	5.7		6.3	V
Line Regulation	$\Delta V_o$	LN1 $T_j = 25^\circ\text{C}$ , $8\text{V} \leq V_{IN} \leq 25\text{V}$ , $I_o = 0.2\text{A}$		1.2	100	mV
		LN2 $T_j = 25^\circ\text{C}$ , $9\text{V} \leq V_{IN} \leq 25\text{V}$ , $I_o = 0.2\text{A}$		0.6	50	mV
Load Regulation	$\Delta V_o$	LD1 $T_j = 25^\circ\text{C}$ , $5\text{mA} \leq I_o \leq 0.5\text{A}$		4.0	120	mV
		LD2 $T_j = 25^\circ\text{C}$ , $5\text{mA} \leq I_o \leq 0.2\text{A}$		2.0	60	mV
Current Dissipation	$I_{CC}$	$T_j = 25^\circ\text{C}$	3.4		6.0	mA
Current Dissipation Variation (Line)	$\Delta I_{CC}$	LN $9\text{V} \leq V_{IN} \leq 25\text{V}$ , $I_o \leq 0.2\text{A}$			0.8	mA
		LD $5\text{mA} \leq I_o \leq 0.35\text{A}$			0.5	mA
Output Noise Voltage	$V_{NO}$	$I_o = 5\text{mA}$ , $10\text{Hz} \leq f \leq 100\text{kHz}$		70		$\mu\text{V}$
Ripple Rejection	Rr1	$T_j = 25^\circ\text{C}$ , $f = 120\text{Hz}$ , $9\text{V} \leq V_{IN} \leq 19\text{V}$ , $I_o = 0.1\text{A}$	59	80		dB
	Rr2	$T_j = 25^\circ\text{C}$ , $f = 120\text{Hz}$ , $9\text{V} \leq V_{IN} \leq 19\text{V}$ , $I_o = 0.3\text{A}$	59	75		dB

Continued on next page.

## L78MR00 Series

Continued from preceding page.

			min	typ	max	unit
Dropout Voltage	$V_{drop}$			2.0	2.5	V
Peak Output Current	$I_{OP}$	$T_j = 25^\circ\text{C}$		1.1		A
Short Circuit Current	$I_{OSC}$	$T_j = 25^\circ\text{C}, V_{IN} = 35\text{V}$		0.02		A
Temperature Coefficient of Output Voltage	$\Delta V_o/\Delta T$	$I_o = 5\text{mA}, T_j = 25 \text{ to } 125^\circ\text{C}$		-0.4		mV/°C
'L' Reset Output Voltage	$V_{ORL}$	$V_o \leq 5.64\text{V}, I_{OR} = 20\text{mA}, I_o = 5\text{mA}$			0.8	V
Reset Output Leakage Current	$I_{RL}$	$V_R = 35\text{V}$			50	$\mu\text{A}$
Reset Threshold Voltage	$V_{RT}$	$I_o = 5\text{mA}$	$V_o - 0.36$	$V_o - 0.24$		V
Reset Hysteresis Voltage	$V_{RTH}$	$I_o = 5\text{mA}$		120		mV
Reset Output Delay Time	$t_d$	$C_d = 0.1\mu\text{F}, I_o = 5\text{mA}$		10		ms

### [L78MR08]

#### Recommended Operating Conditions at $T_a = 25^\circ\text{C}$

				unit
Input Voltage	$V_{IN}$		10.5 to 23	V
Output Current	$I_o$		5 to 500	mA
Reset Output Current	$I_{OR}$	$V_o \leq 7.2\text{V}$	20	mA max

#### Operating Characteristics at $T_a = 25^\circ\text{C}, V_{IN} = 14\text{V}, I_o = 0.35\text{A}, C_o = 10\mu\text{F}$

			min	typ	max	unit
Output Voltage	$V_{o1}$	$T_j = 25^\circ\text{C}$	7.7	8.0	8.3	V
	$V_{o2}$	$10.5\text{V} \leq V_{IN} \leq 23\text{V},$ $5\text{mA} \leq I_o \leq 0.35\text{A}$	7.6		8.4	V
Line Regulation	$\Delta V_o$	LN1 $T_j = 25^\circ\text{C}, 10.5\text{V} \leq V_{IN} \leq 25\text{V},$ $I_o = 0.2\text{A}$		1.6	100	mV
		LN2 $T_j = 25^\circ\text{C}, 11\text{V} \leq V_{IN} \leq 25\text{V},$ $I_o = 0.2\text{A}$		0.8	50	mV
Load Regulation	$\Delta V_o$	LD1 $T_j = 25^\circ\text{C}, 5\text{mA} \leq I_o \leq 0.5\text{A}$		5.0	160	mV
		LD2 $T_j = 25^\circ\text{C}, 5\text{mA} \leq I_o \leq 0.2\text{A}$		2.0	80	mV
Current Dissipation	$I_{CC}$	$T_j = 25^\circ\text{C}$		3.5	6.0	mA
Current Dissipation Variation (Line)	$\Delta I_{CC}$	LN $10.5\text{V} \leq V_{IN} \leq 25\text{V}, I_o \leq 0.2\text{A}$			0.8	mA
Current Dissipation Variation (Load)	$\Delta I_{CC}$	LD $5\text{mA} \leq I_o \leq 0.35\text{A}$			0.5	mA
Output Noise Voltage	$V_{NO}$	$I_o = 5\text{mA}, 10\text{Hz} \leq f \leq 100\text{kHz}$		100		$\mu\text{V}$
Ripple Rejection	Rr1	$T_j = 25^\circ\text{C}, f = 120\text{Hz},$ $11.5\text{V} \leq V_{IN} \leq 21.5\text{V}, I_o = 0.1\text{A}$	56	75		dB
	Rr2	$T_j = 25^\circ\text{C}, f = 120\text{Hz},$ $11.5\text{V} \leq V_{IN} \leq 21.5\text{V}, I_o = 0.3\text{A}$	56	71		dB
Dropout Voltage	$V_{drop}$			2.0	2.5	V
Peak Output Current	$I_{OP}$	$T_j = 25^\circ\text{C}$		1.1		A
Short Circuit Current	$I_{OSC}$	$T_j = 25^\circ\text{C}, V_{IN} = 35\text{V}$		0.02		A
Temperature Coefficient of Output Voltage	$\Delta V_o/\Delta T$	$I_o = 5\text{mA}, T_j = 25 \text{ to } 125^\circ\text{C}$		-0.7		mV/°C
'L' Reset Output Voltage	$V_{ORL}$	$V_o \leq 7.2\text{V}, I_{OR} = 20\text{mA}, I_o = 5\text{mA}$			0.8	V
Reset Output Leakage Current	$I_{RL}$	$V_R = 35\text{V}$			50	$\mu\text{A}$
Reset Threshold Voltage	$V_{RT}$	$I_o = 5\text{mA}$	$V_o - 0.48$	$V_o - 0.32$		V
Reset Hysteresis Voltage	$V_{RTH}$	$I_o = 5\text{mA}$		160		mV
Reset Output Delay Time	$t_d$	$C_d = 0.1\mu\text{F}, I_o = 5\text{mA}$		10		ms

## L78MR00 Series

### [L78MR09]

#### Recommended Operating Conditions at $T_a = 25^\circ\text{C}$

Parameter	Symbol	Condition	min	typ	max	unit
Input Voltage	$V_{IN}$			12 to 24		V
Output Current	$I_o$			5 to 500		mA
Reset Output Current	$I_{OR}$	$V_o \leq 8.1\text{V}$		20		mA max

#### Operating Characteristics at $T_a = 25^\circ\text{C}$ , $V_{IN} = 15\text{V}$ , $I_o = 0.35\text{A}$ , $C_o = 10\mu\text{F}$

Parameter	Symbol	Condition	min	typ	max	unit
Output Voltage	$V_{o1}$	$T_j = 25^\circ\text{C}$	8.6	9.0	9.4	V
	$V_{o2}$	$11.5\text{V} \leq V_{IN} \leq 24\text{V}$ , $5\text{mA} \leq I_o \leq 0.35\text{A}$	8.5		9.5	V
Line Regulation	$\Delta V_o$	LN1 $T_j = 25^\circ\text{C}$ , $11.5\text{V} \leq V_{IN} \leq 25\text{V}$ , $I_o = 0.2\text{A}$		1.6	100	mV
		LN2 $T_j = 25^\circ\text{C}$ , $12\text{V} \leq V_{IN} \leq 25\text{V}$ , $I_o = 0.2\text{A}$		0.8	50	mV
Load Regulation	$\Delta V_o$	LD1 $T_j = 25^\circ\text{C}$ , $5\text{mA} \leq I_o \leq 0.5\text{A}$		5.0	180	mV
		LD2 $T_j = 25^\circ\text{C}$ , $5\text{mA} \leq I_o \leq 0.2\text{A}$		3.0	90	mV
Current Dissipation	$I_{CC}$	$T_j = 25^\circ\text{C}$		3.5	6.0	mA
Current Dissipation Variation (Line)	$\Delta I_{CC}$	LN $11.5\text{V} \leq V_{IN} \leq 25\text{V}$ , $I_o \leq 0.2\text{A}$			0.8	mA
		LD $5\text{mA} \leq I_o \leq 0.35\text{A}$			0.5	mA
Output Noise Voltage	$V_{NO}$	$I_o = 5\text{mA}$ , $10\text{Hz} \leq f \leq 100\text{kHz}$		110		$\mu\text{V}$
Ripple Rejection	$R_{r1}$	$T_j = 25^\circ\text{C}$ , $f = 120\text{Hz}$ , $12\text{V} \leq V_{IN} \leq 22\text{V}$ , $I_o = 0.1\text{A}$	56	73		dB
		$T_j = 25^\circ\text{C}$ , $f = 120\text{Hz}$ , $12\text{V} \leq V_{IN} \leq 22\text{V}$ , $I_o = 0.3\text{A}$	56	70		dB
Dropout Voltage	$V_{drop}$			2.0	2.5	V
Peak Output Current	$I_{OP}$	$T_j = 25^\circ\text{C}$		1.1		A
Short Circuit Current	$I_{OSC}$	$T_j = 25^\circ\text{C}$ , $V_{IN} = 35\text{V}$		0.02		A
Temperature Coefficient of Output Voltage	$\Delta V_o/\Delta T$	$I_o = 5\text{mA}$ , $T_j = 25$ to $125^\circ\text{C}$	-0.9			mV/°C
'L' Reset Output Voltage	$V_{ORL}$	$V_o \leq 8.1\text{V}$ , $I_{OR} = 20\text{mA}$ , $I_o = 5\text{mA}$			0.8	V
Reset Output Leakage Current	$I_{RL}$	$V_R = 35\text{V}$			50	$\mu\text{A}$
Reset Threshold Voltage	$V_{RT}$	$I_o = 5\text{mA}$		$V_o - 0.54 V_o - 0.36$		V
Reset Hysteresis Voltage	$V_{RTH}$	$I_o = 5\text{mA}$		180		mV
Reset Output Delay Time	$t_d$	$C_d = 0.1\mu\text{F}$ , $I_o = 5\text{mA}$		10		ms

### [L78MR12]

#### Recommended Operating Conditions at $T_a = 25^\circ\text{C}$

Parameter	Symbol	Condition	min	typ	max	unit
Input Voltage	$V_{IN}$			15 to 27		V
Output Current	$I_o$			5 to 500		mA
Reset Output Current	$I_{OR}$	$V_o \leq 10.8\text{V}$		20		mA max

#### Operating Characteristics at $T_a = 25^\circ\text{C}$ , $V_{IN} = 19\text{V}$ , $I_o = 0.35\text{A}$ , $C_o = 10\mu\text{F}$

Parameter	Symbol	Condition	min	typ	max	unit
Output Voltage	$V_{o1}$	$T_j = 25^\circ\text{C}$	11.5	12.0	12.5	V
	$V_{o2}$	$14.5\text{V} \leq V_{IN} \leq 27\text{V}$ , $5\text{mA} \leq I_o \leq 0.35\text{A}$	11.4		12.6	V
Line Regulation	$\Delta V_o$	LN1 $T_j = 25^\circ\text{C}$ , $14.5\text{V} \leq V_{IN} \leq 30\text{V}$ , $I_o = 0.2\text{A}$		2.4	100	mV
		LN2 $T_j = 25^\circ\text{C}$ , $16\text{V} \leq V_{IN} \leq 30\text{V}$ , $I_o = 0.2\text{A}$		1.2	50	mV
Load Regulation	$\Delta V_o$	LD1 $T_j = 25^\circ\text{C}$ , $5\text{mA} \leq I_o \leq 0.5\text{A}$		7.0	240	mV
		LD2 $T_j = 25^\circ\text{C}$ , $5\text{mA} \leq I_o \leq 0.2\text{A}$		4.0	120	mV
Current Dissipation	$I_{CC}$	$T_j = 25^\circ\text{C}$		3.7	6.0	mA

Continued on next page.

## L78MR00 Series

Continued from preceding page.

				min	typ	max	unit
Current Dissipation Variation (Line)	$\Delta I_{CC}$ LN	$14.5V \leq V_{IN} \leq 30V, I_o \leq 0.2A$				0.8	mA
	$\Delta I_{CC}$ LD	$5mA \leq I_o \leq 0.35A$				0.5	mA
Output Noise Voltage	$V_{NO}$	$I_o = 5mA, 10Hz \leq f \leq 100kHz$			140		$\mu V$
Ripple Rejection	Rr1	$T_j = 25^\circ C, f = 120Hz, 15V \leq V_{IN} \leq 25V, I_o = 0.1A$		55	68		dB
	Rr2	$T_j = 25^\circ C, f = 120Hz, 15V \leq V_{IN} \leq 25V, I_o = 0.3A$		55	66		dB
	$V_{drop}$				2.0	2.5	V
Peak Output Current	$I_{OP}$	$T_j = 25^\circ C$			1.1		A
Short Circuit Current	$I_{OSC}$	$T_j = 25^\circ C, V_{IN} = 35V$			0.02		A
Temperature Coefficient of Output Voltage	$\Delta V_o / \Delta T$	$I_o = 5mA, T_j = 25 \text{ to } 125^\circ C$			-1.6		mV/°C
'L' Reset Output Voltage	$V_{ORL}$	$V_o \leq 10.8V, I_{OR} = 20mA, I_o = 5mA$				0.8	V
Reset Output Leakage Current	$I_{RL}$	$V_R = 35V$				50	$\mu A$
Reset Threshold Voltage	$V_{RT}$	$I_o = 5mA$			$V_o - 0.72$	$V_o - 0.48$	V
Reset Hysteresis Voltage	$V_{RTH}$	$I_o = 5mA$			240		mV
Reset Output Delay Time	$t_d$	$C_d = 0.1\mu F, I_o = 5mA$			10		ms

### Sample Application Circuit

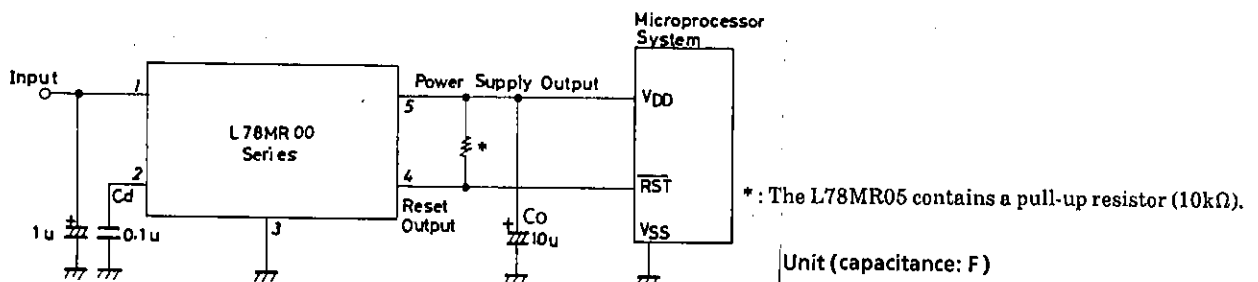

Note on use) If a load current (in particular, pulse-like load current) that is greater than a rated value is used, a reset signal may be generated due to the overload. Please keep it in mind.

### L78MR05 Reset Operation

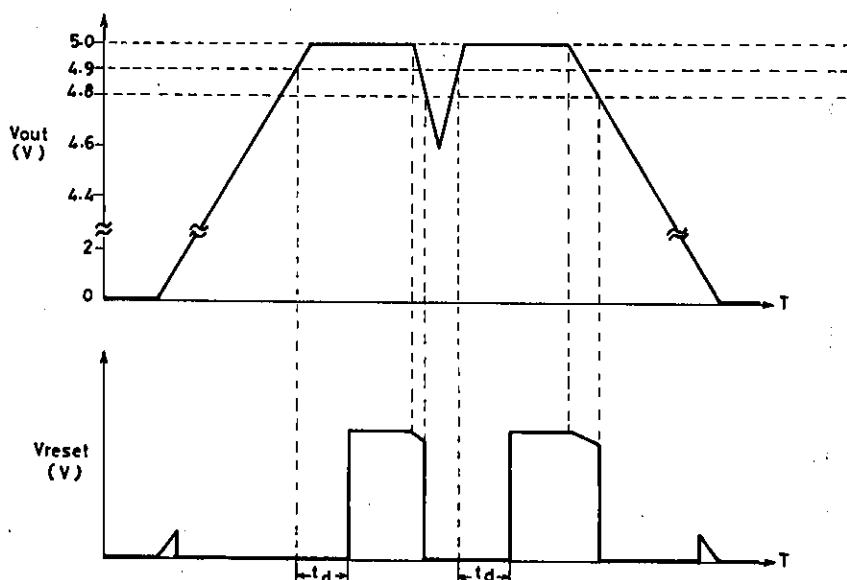

# L78MR00 Series

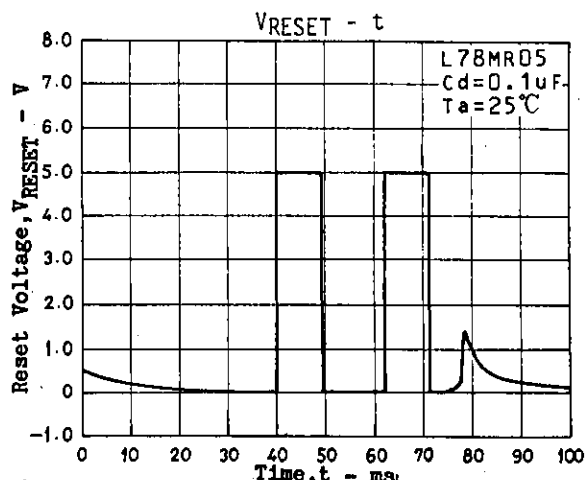
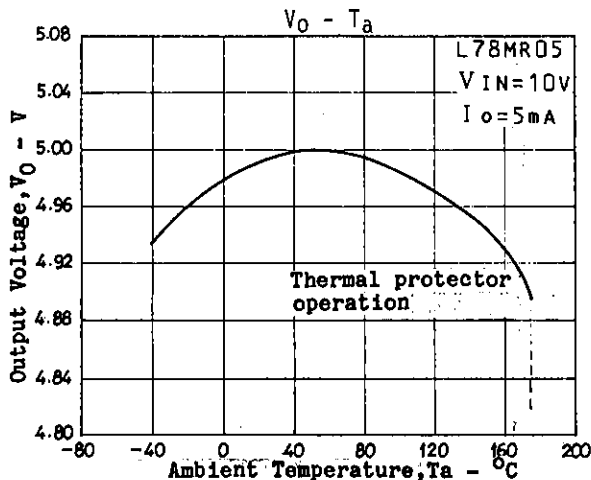
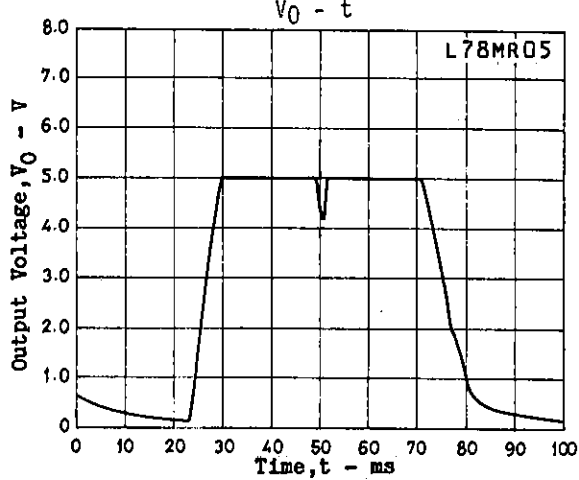
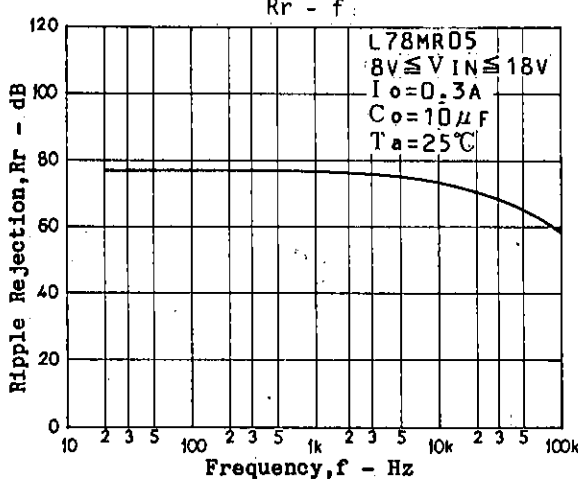
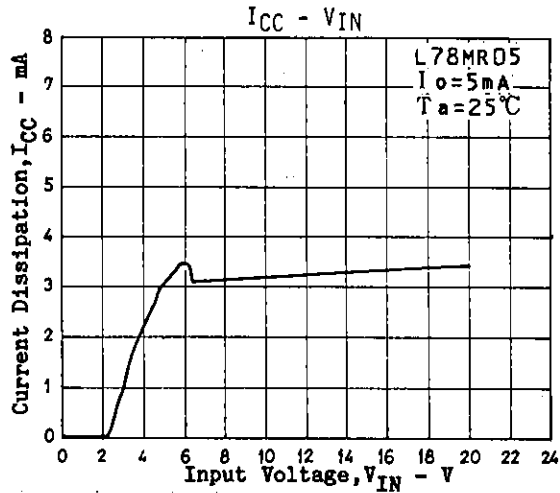
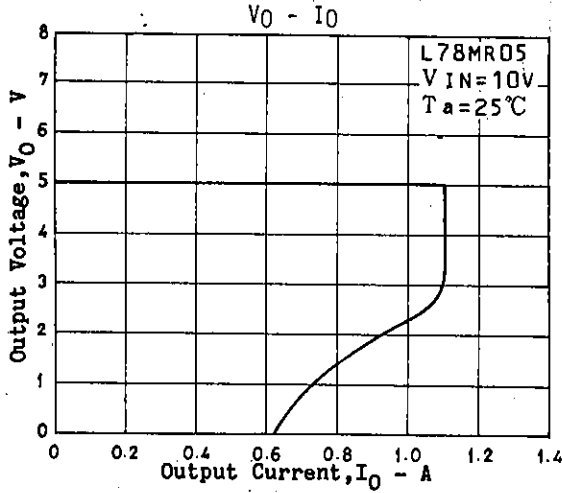
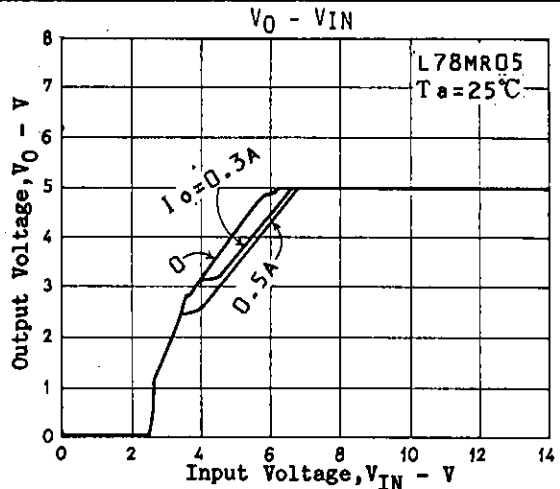
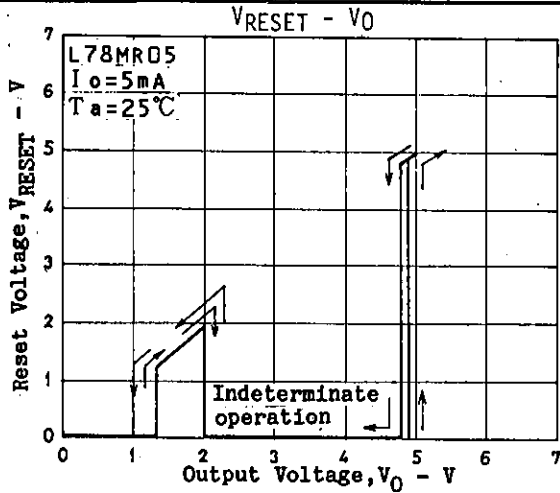

# L78MR00 Series

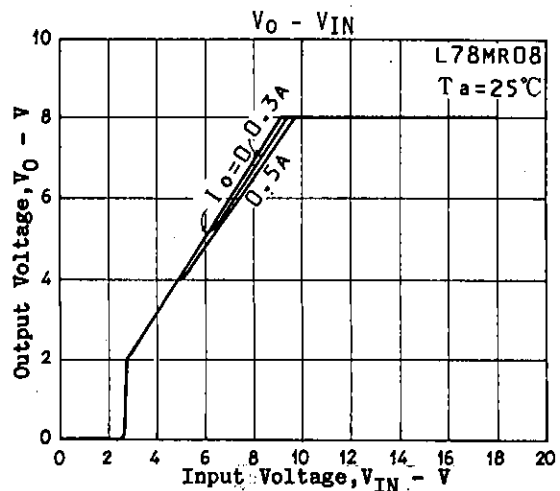
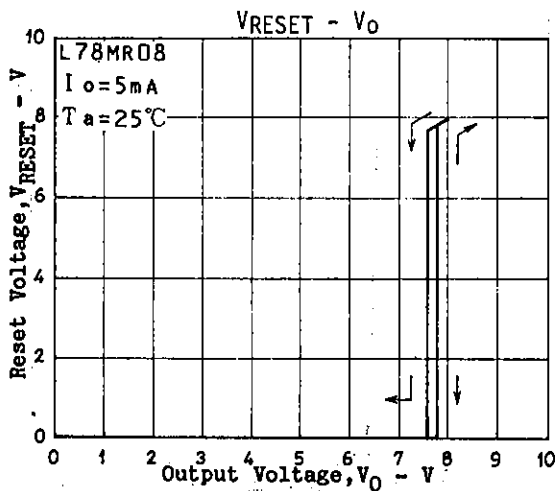
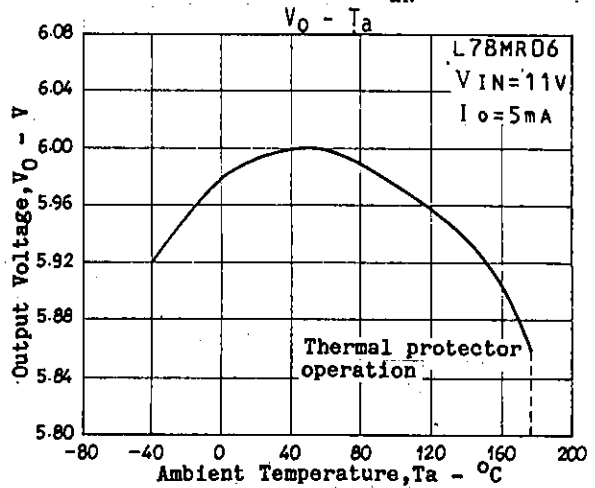
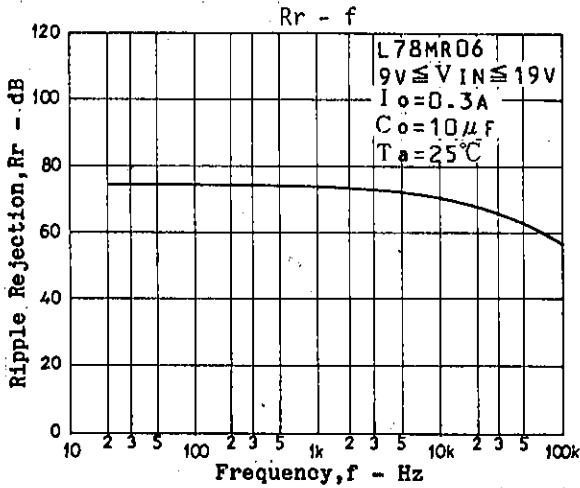
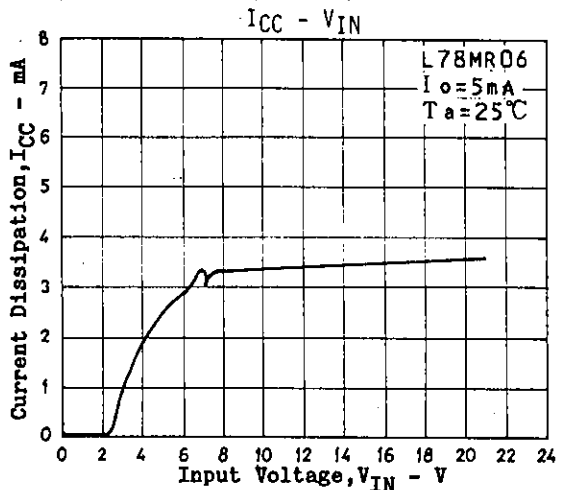
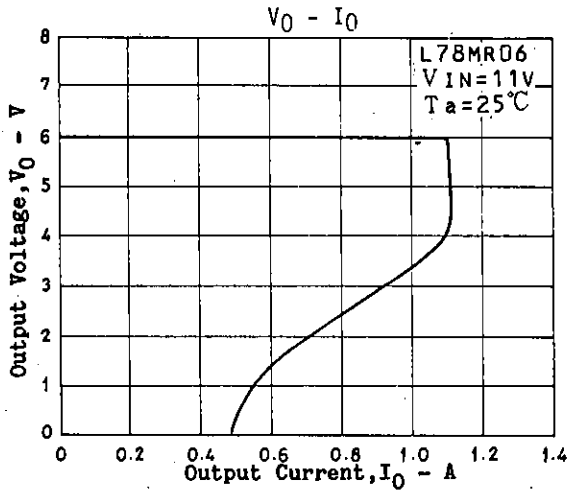
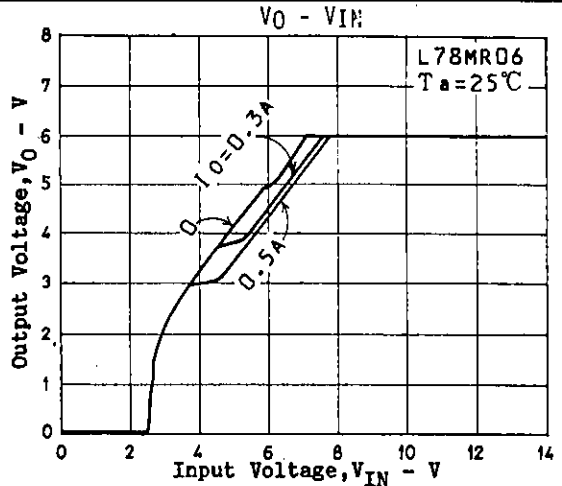
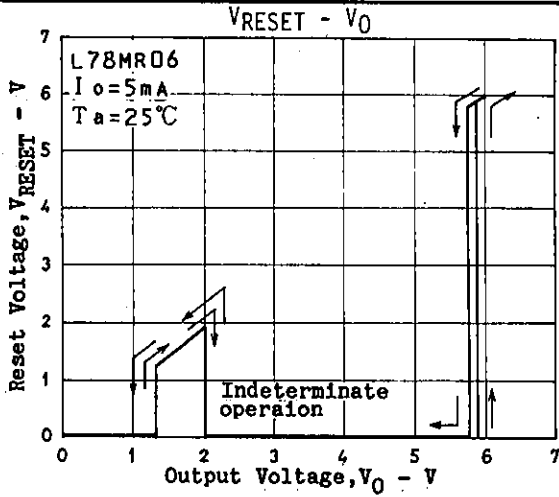

# L78MR00 Series

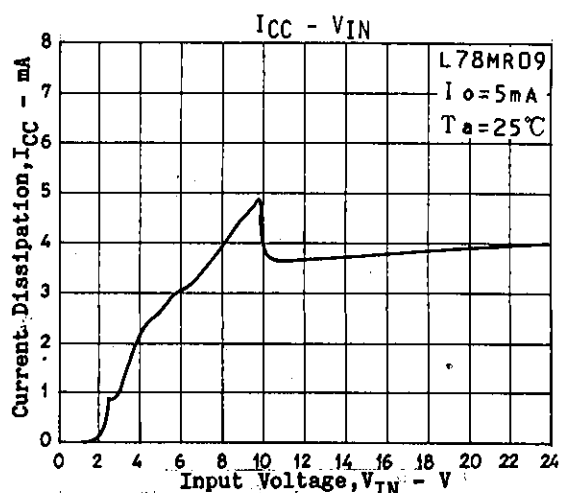
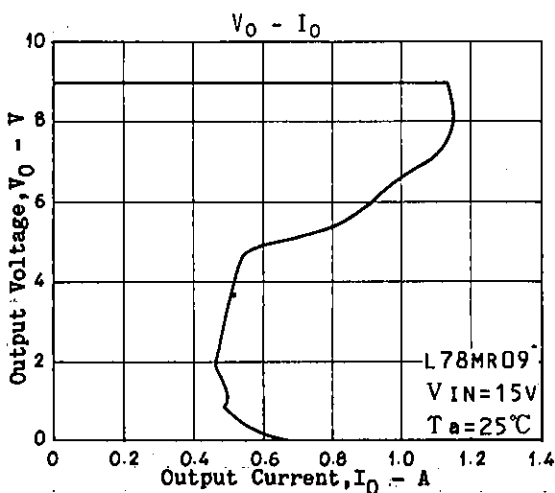
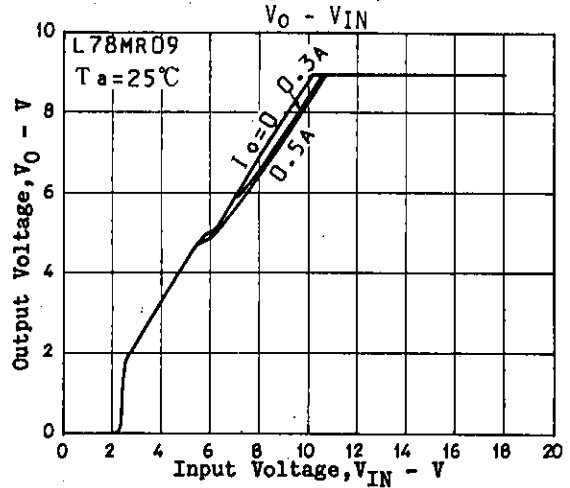
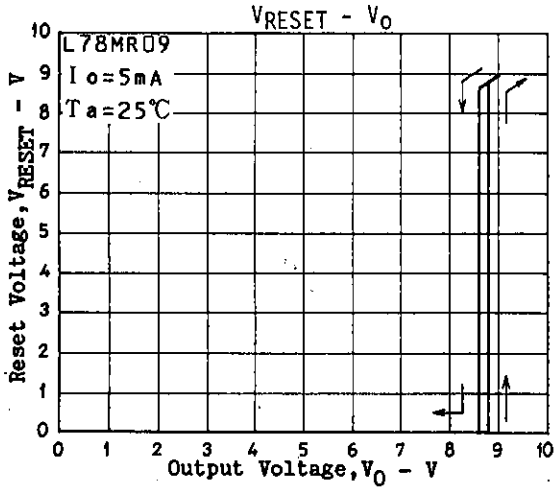
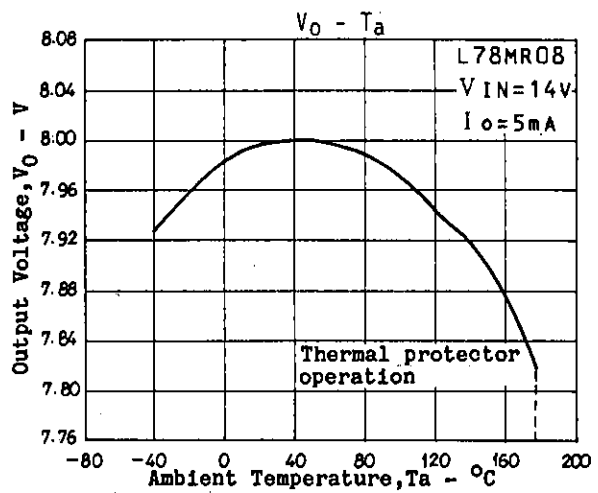
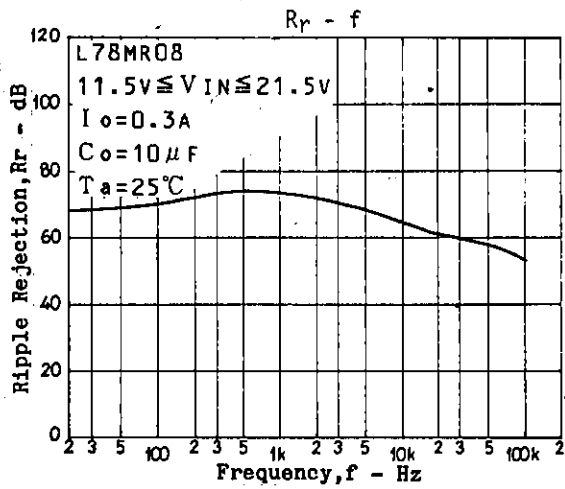
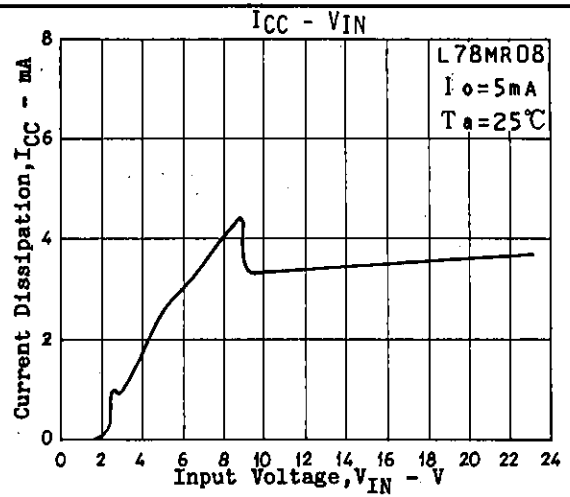
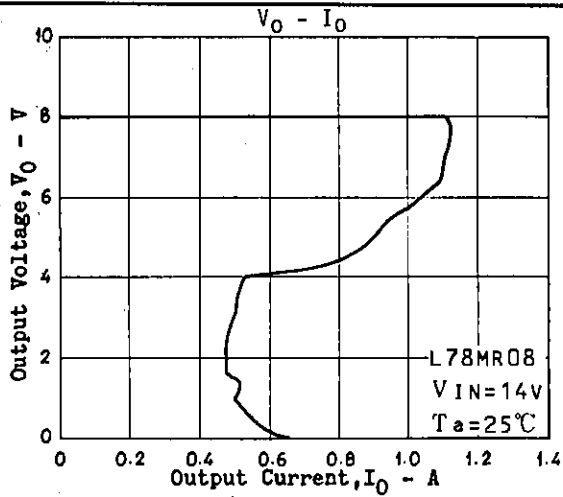



# L78MR00 Series

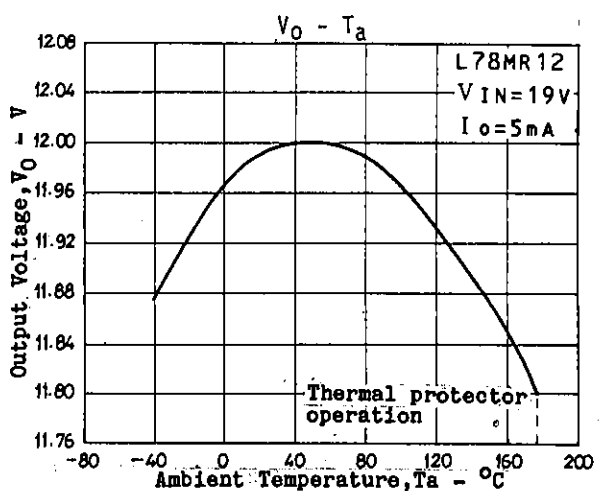
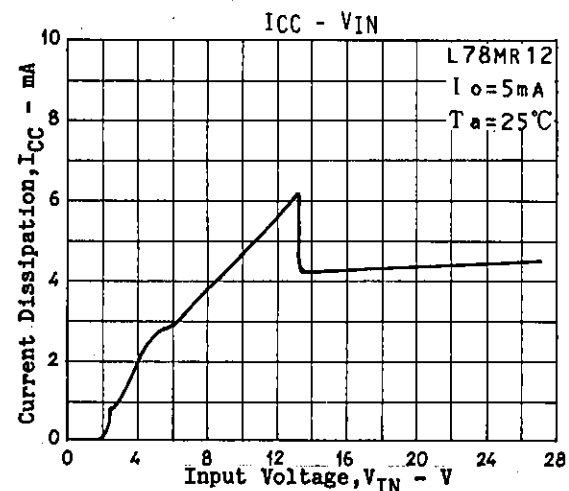
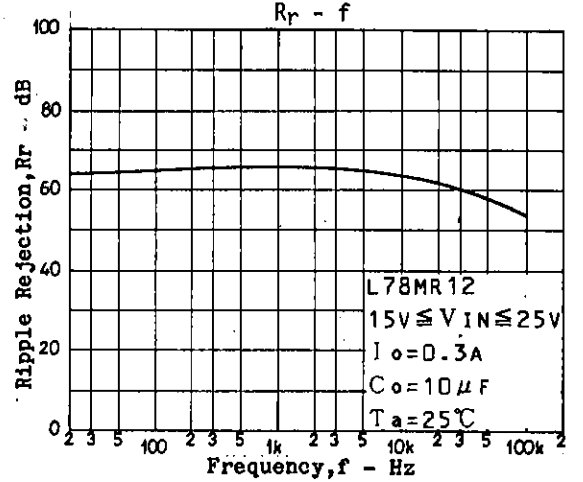
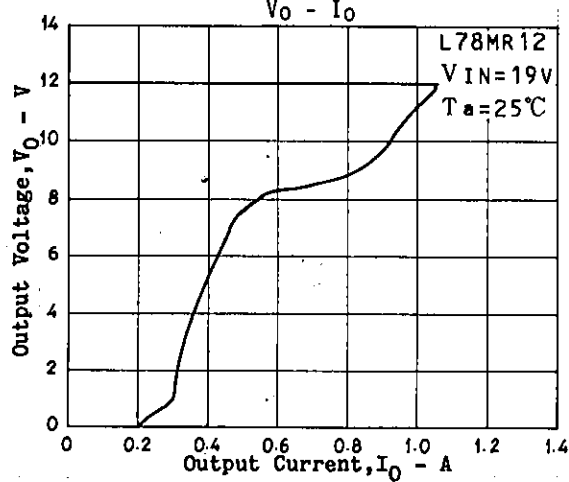
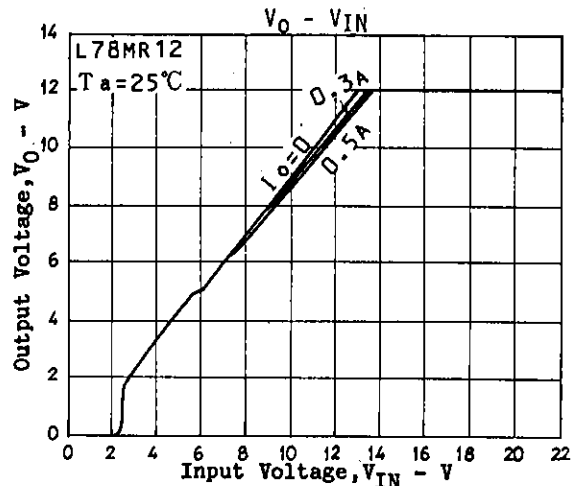
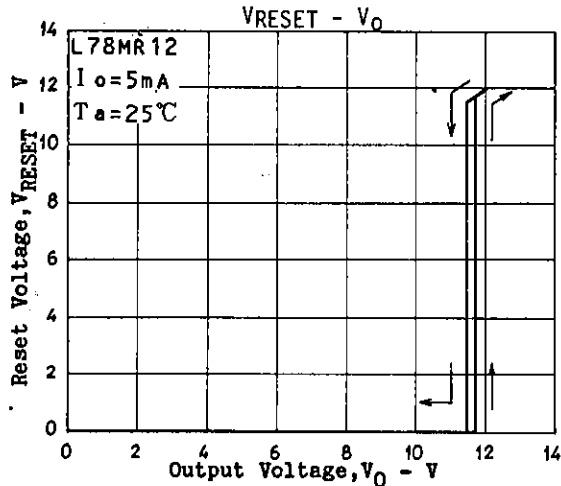
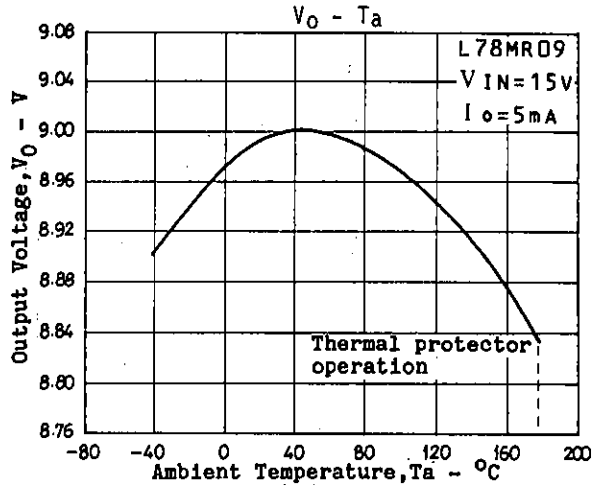
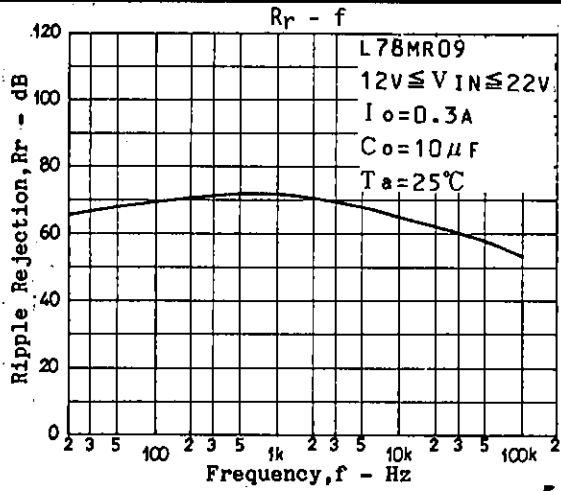

# L78MR00 Series

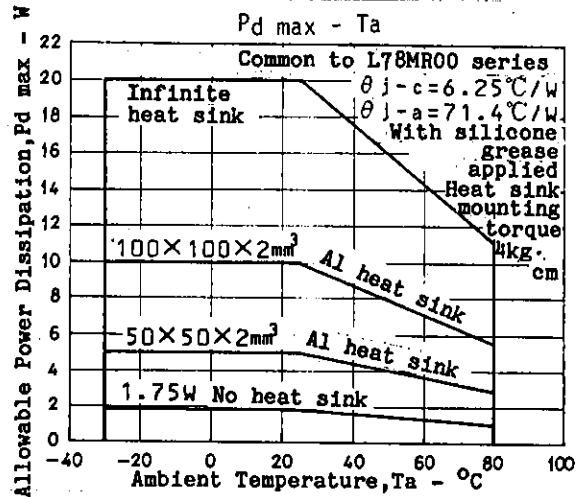
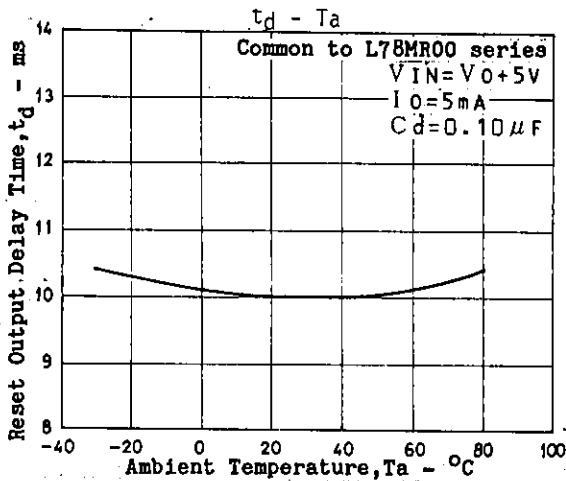
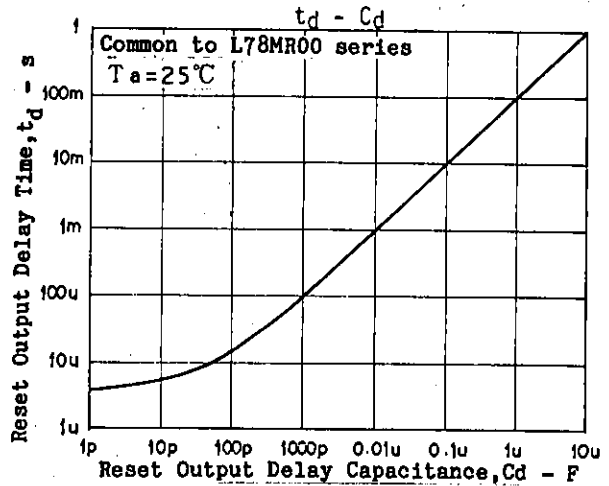
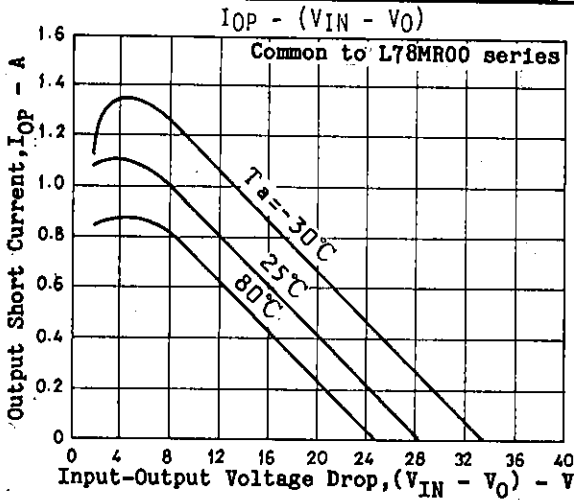

- No products described or contained herein are intended for use in surgical implants, life-support systems, aerospace equipment, nuclear power control systems, vehicles, disaster/crime-prevention equipment and the like, the failure of which may directly or indirectly cause injury, death or property loss.
- Anyone purchasing any products described or contained herein for an above-mentioned use shall:
  - ① Accept full responsibility and indemnify and defend SANYO ELECTRIC CO., LTD., its affiliates, subsidiaries and distributors and all their officers and employees, jointly and severally, against any and all claims and litigation and all damages, cost and expenses associated with such use;
  - ② Not impose any responsibility for any fault or negligence which may be cited in any such claim or litigation on SANYO ELECTRIC CO., LTD., its affiliates, subsidiaries and distributors or any of their officers and employees jointly or severally.
- Information (including circuit diagrams and circuit parameters) herein is for example only; it is not guaranteed for volume production. SANYO believes information herein is accurate and reliable, but no guarantees are made or implied regarding its use or any infringements of intellectual property rights or other rights of third parties.

This datasheet has been download from:

[www.datasheetcatalog.com](http://www.datasheetcatalog.com)

Datasheets for electronics components.