

MJD112 (NPN) MJD117 (PNP)

Preferred Device

Complementary Darlington Power Transistors

DPAK For Surface Mount Applications

Designed for general purpose power and switching such as output or driver stages in applications such as switching regulators, converters, and power amplifiers.

Features

- Pb-Free Packages are Available
- Lead Formed for Surface Mount Applications in Plastic Sleeves (No Suffix)
- Straight Lead Version in Plastic Sleeves (“-1” Suffix)
- Lead Formed Version in 16 mm Tape and Reel (“T4” and “RL” Suffix)
- Electrically Similar to Popular TIP31 and TIP32 Series

MAXIMUM RATINGS

Rating	Symbol	Max	Unit
Collector-Emitter Voltage	V_{CEO}	100	Vdc
Collector-Base Voltage	V_{CB}	100	Vdc
Emitter-Base Voltage	V_{EB}	5	Vdc
Collector Current – Continuous Peak	I_C	2 4	Adc
Base Current	I_B	50	mAdc
Total Power Dissipation @ $T_C = 25^\circ\text{C}$ Derate above 25°C	P_D	20 0.16	W W/ $^\circ\text{C}$
Total Power Dissipation* @ $T_A = 25^\circ\text{C}$ Derate above 25°C	P_D	1.75 0.014	W W/ $^\circ\text{C}$
Operating and Storage Junction Temperature Range	T_J, T_{stg}	-65 to +150	$^\circ\text{C}$

Maximum ratings are those values beyond which device damage can occur. Maximum ratings applied to the device are individual stress limit values (not normal operating conditions) and are not valid simultaneously. If these limits are exceeded, device functional operation is not implied, damage may occur and reliability may be affected.

THERMAL CHARACTERISTICS

Characteristic	Symbol	Max	Unit
Thermal Resistance, Junction-to-Case	$R_{\theta JC}$	6.25	$^\circ\text{C}/\text{W}$
Thermal Resistance, Junction-to-Ambient*	$R_{\theta JA}$	71.4	$^\circ\text{C}/\text{W}$

*These ratings are applicable when surface mounted on the minimum pad sizes recommended.



ON Semiconductor®

<http://onsemi.com>

**SILICON
POWER TRANSISTORS
2 AMPERES
100 VOLTS
20 WATTS**

MARKING DIAGRAMS

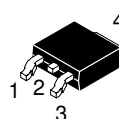

DPAK
CASE 369C

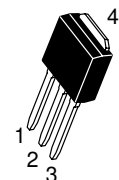
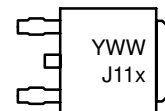

DPAK-3
CASE 369D

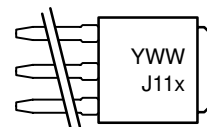

Y = Year
WW = Work Week
x = 2 or 7

ORDERING INFORMATION

See detailed ordering and shipping information in the package dimensions section on page 2 of this data sheet.

Preferred devices are recommended choices for future use and best overall value.

MJD112 (NPN) MJD117 (PNP)

ELECTRICAL CHARACTERISTICS ($T_C = 25^\circ\text{C}$ unless otherwise noted)

Characteristic	Symbol	Min	Max	Unit
OFF CHARACTERISTICS				
Collector-Emitter Sustaining Voltage (1) ($I_C = 30\text{ mA}$, $I_B = 0$)	$V_{CE(sus)}$	100	–	Vdc
Collector Cutoff Current ($V_{CE} = 50\text{ Vdc}$, $I_B = 0$)	I_{CEO}	–	20	μA
Collector Cutoff Current ($V_{CB} = 100\text{ Vdc}$, $I_E = 0$)	I_{CBO}	–	20	μA
Emitter Cutoff Current ($V_{BE} = 5\text{ Vdc}$, $I_C = 0$)	I_{EBO}	–	2	mA
Collector-Cutoff Current ($V_{CB} = 80\text{ Vdc}$, $I_E = 0$)	I_{CBO}	–	10	μA
Emitter-Cutoff Current ($V_{BE} = 5\text{ Vdc}$, $I_C = 0$)	I_{EBO}	–	2	mA

ON CHARACTERISTICS

DC Current Gain ($I_C = 0.5\text{ A}$, $V_{CE} = 3\text{ Vdc}$) ($I_C = 2\text{ A}$, $V_{CE} = 3\text{ Vdc}$) ($I_C = 4\text{ A}$, $V_{CE} = 3\text{ Vdc}$)	h_{FE}	500 1000 200	– 12,000 –	–
Collector-Emitter Saturation Voltage ($I_C = 2\text{ A}$, $I_B = 8\text{ mA}$) ($I_C = 4\text{ A}$, $I_B = 40\text{ mA}$)	$V_{CE(sat)}$	– –	2 3	Vdc
Base-Emitter Saturation Voltage ($I_C = 4\text{ A}$, $I_B = 40\text{ mA}$)	$V_{BE(sat)}$	–	4	Vdc
Base-Emitter On Voltage ($I_C = 2\text{ A}$, $V_{CE} = 3\text{ Vdc}$)	$V_{BE(on)}$	–	2.8	Vdc

DYNAMIC CHARACTERISTICS

Current-Gain – Bandwidth Product ($I_C = 0.75\text{ A}$, $V_{CE} = 10\text{ Vdc}$, $f = 1\text{ MHz}$)	f_T	25	–	MHz
Output Capacitance ($V_{CB} = 10\text{ Vdc}$, $I_E = 0$, $f = 0.1\text{ MHz}$)	C_{ob}	– –	200 100	pF

1. Pulse Test: Pulse Width $\leq 300\ \mu\text{s}$, Duty Cycle $\leq 2\%$.

*These ratings are applicable when surface mounted on the minimum pad sizes recommended.

ORDERING INFORMATION

Device	Package Type	Package	Shipping†
MJD112	DPAK	369C	75 Units / Rail
MJD112-001	DPAK-3	369D	75 Units / Rail
MJD112RL	DPAK	369C	1800 Tape & Reel
MJD112T4	DPAK	369C	2500 Tape & Reel
MJD112T4G	DPAK (Pb-Free)	369C	2500 Tape & Reel
MJD117	DPAK	369C	75 Units / Rail
MJD117G	DPAK (Pb-Free)	369C	75 Units / Rail
MJD117-001	DPAK-3	369D	75 Units / Rail
MJD117T4	DPAK	369C	2500 Tape & Reel

†For information on tape and reel specifications, including part orientation and tape sizes, please refer to our Tape and Reel Packaging Specifications Brochure, BRD8011/D.

MJD112 (NPN) MJD117 (PNP)

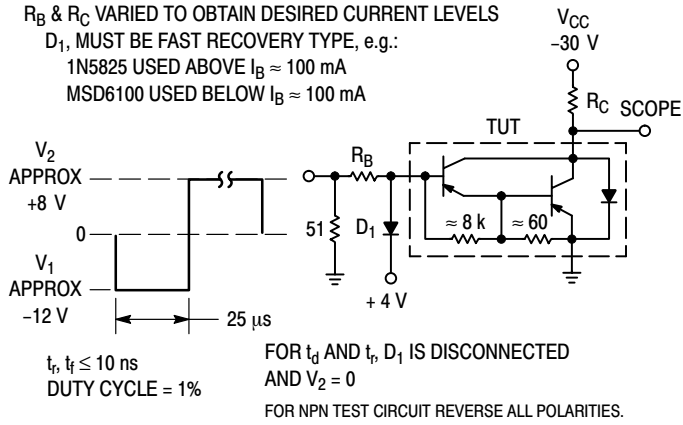

Figure 1. Switching Times Test Circuit

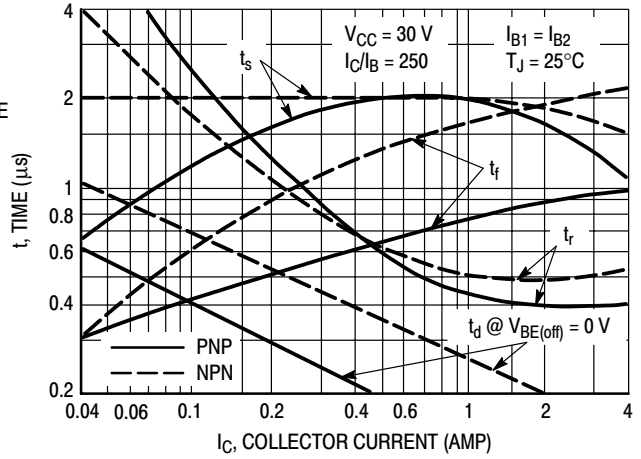

Figure 2. Switching Times

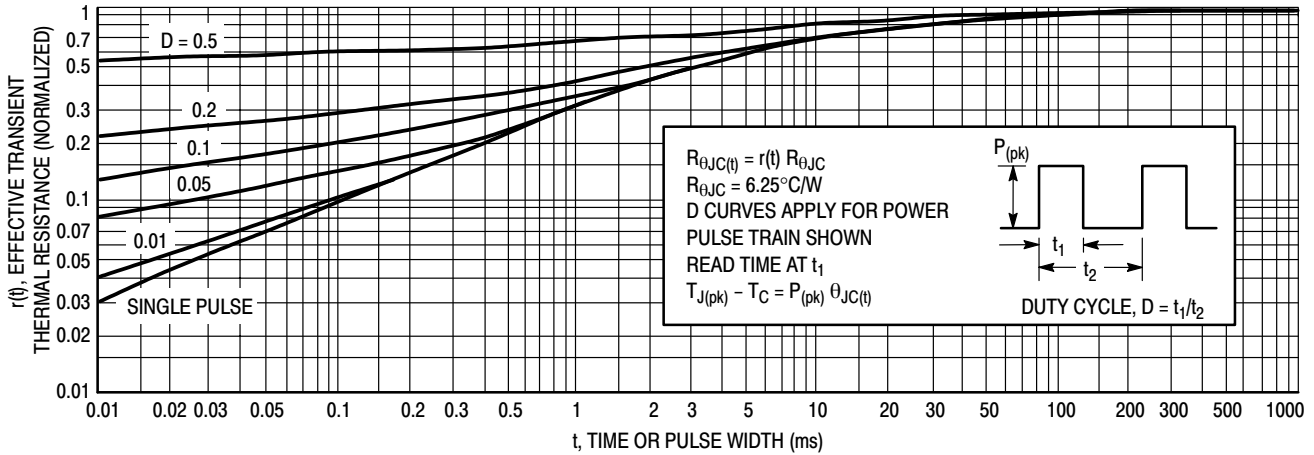

Figure 3. Thermal Response

MJD112 (NPN) MJD117 (PNP)

ACTIVE-REGION SAFE-OPERATING AREA

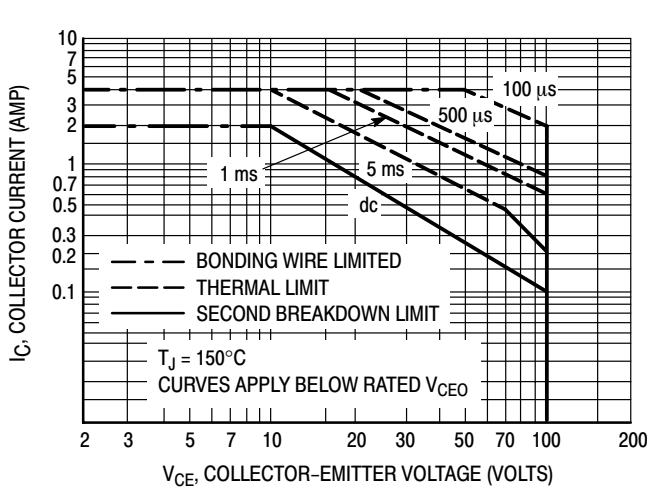

Figure 4. Maximum Rated Forward Biased Safe Operating Area

There are two limitations on the power handling ability of a transistor: average junction temperature and second breakdown. Safe operating area curves indicate $I_C - V_{CE}$ limits of the transistor that must be observed for reliable operation; i.e., the transistor must not be subjected to greater dissipation than the curves indicate.

The data of Figures 5 and 6 is based on $T_{J(pk)} = 150^\circ\text{C}$; T_C is variable depending on conditions. Second breakdown pulse limits are valid for duty cycles to 10% provided $T_{J(pk)} < 150^\circ\text{C}$. $T_{J(pk)}$ may be calculated from the data in Figure 4. At high case temperatures, thermal limitations will reduce the power that can be handled to values less than the limitations imposed by second breakdown.

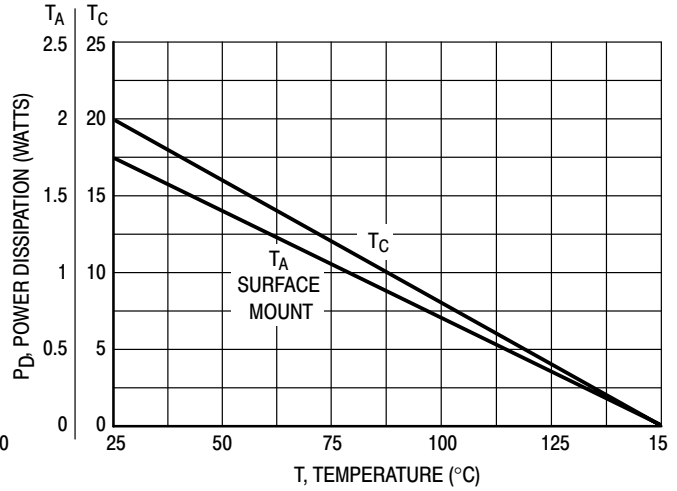

Figure 5. Power Derating

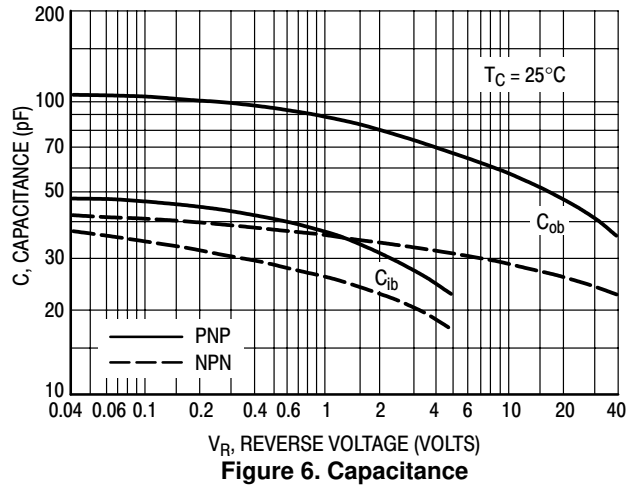

Figure 6. Capacitance

MJD112 (NPN) MJD117 (PNP)

TYPICAL ELECTRICAL CHARACTERISTICS

NPN MJD112

PNP MJD117

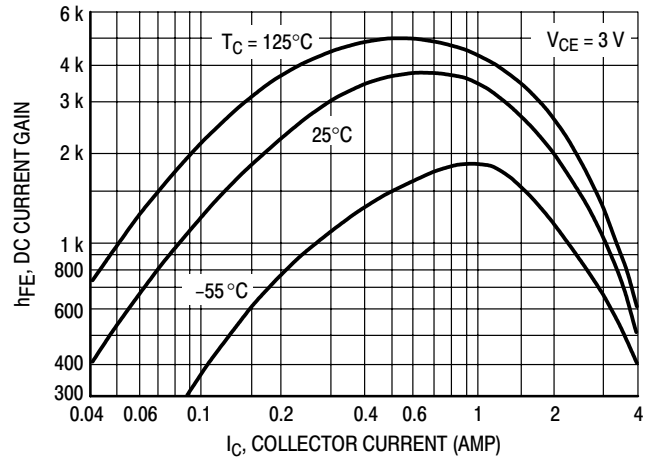
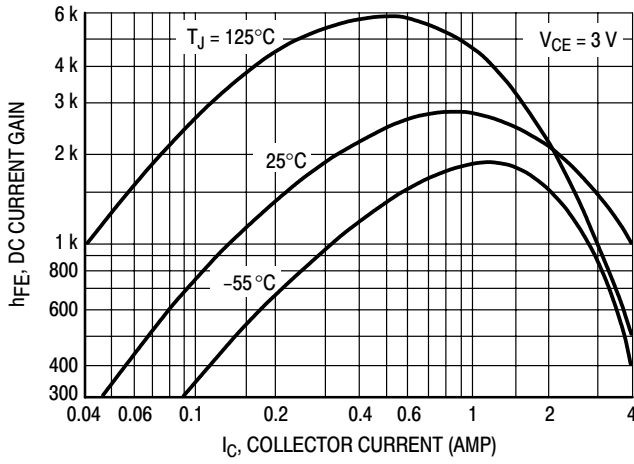

Figure 7. DC Current Gain

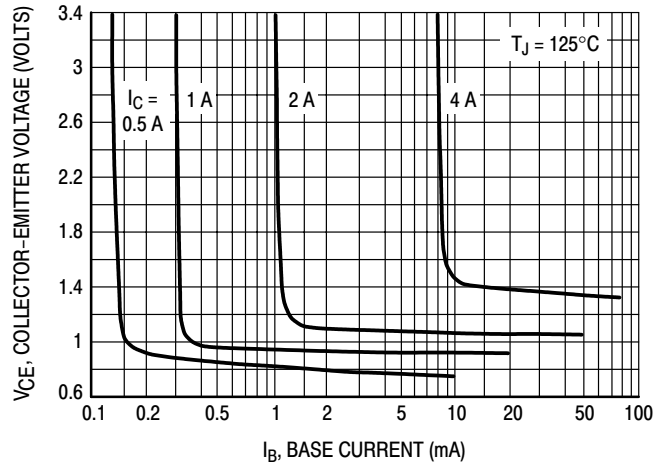
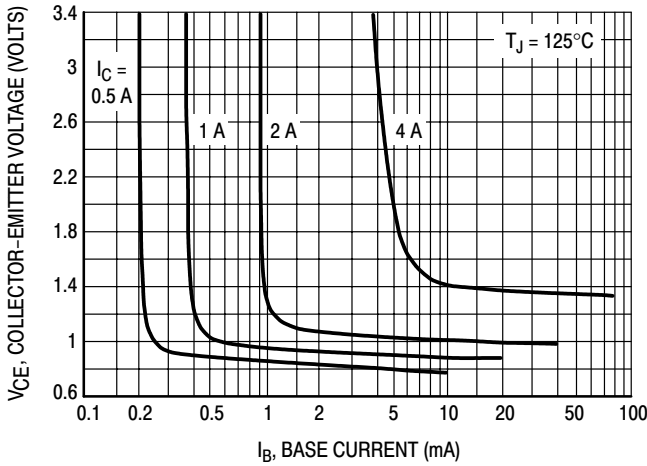

Figure 8. Collector Saturation Region

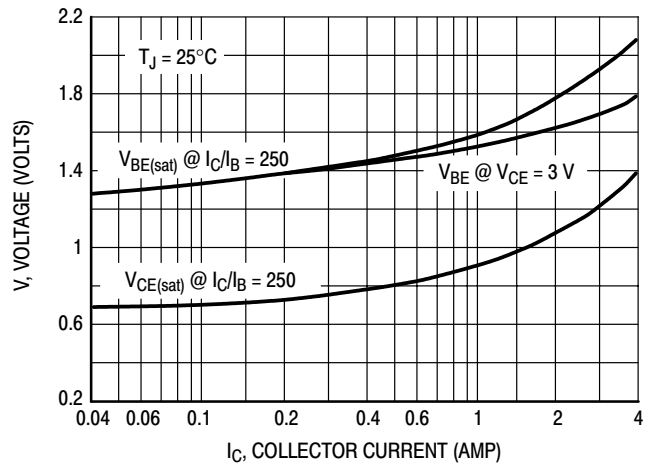
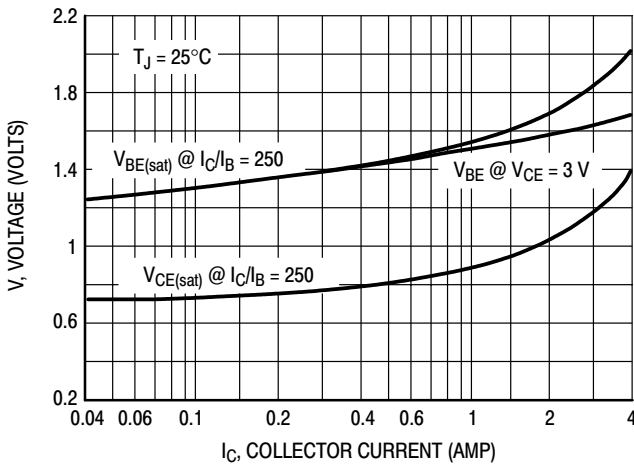

Figure 9. "On Voltages"

MJD112 (NPN) MJD117 (PNP)

NPN MJD112

PNP MJD117

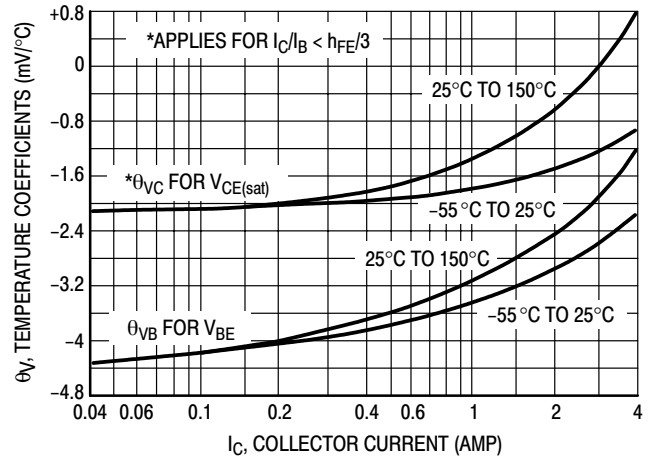
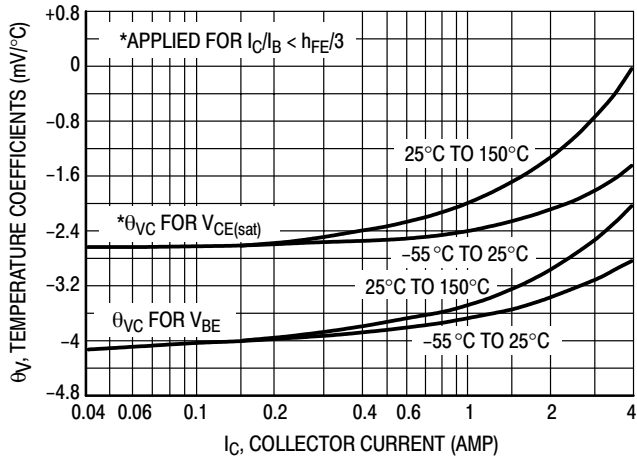

Figure 10. Temperature Coefficients

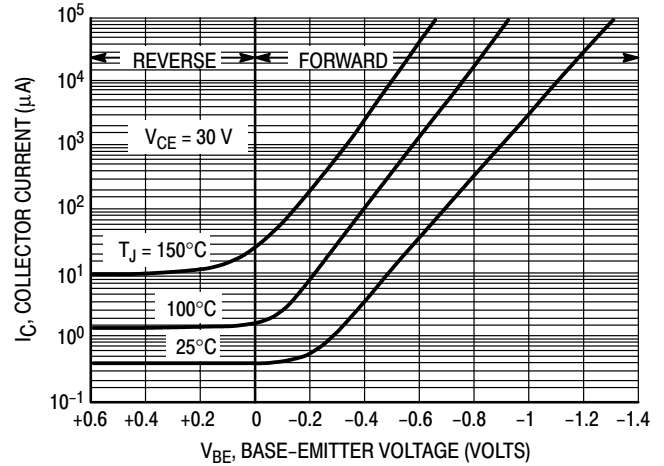
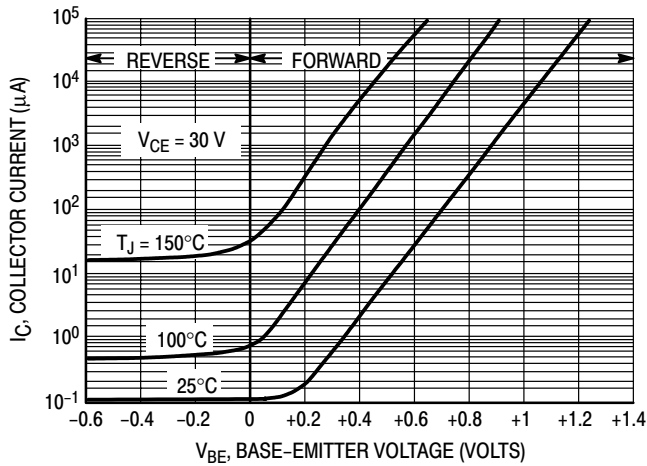

Figure 11. Collector Cut-Off Region

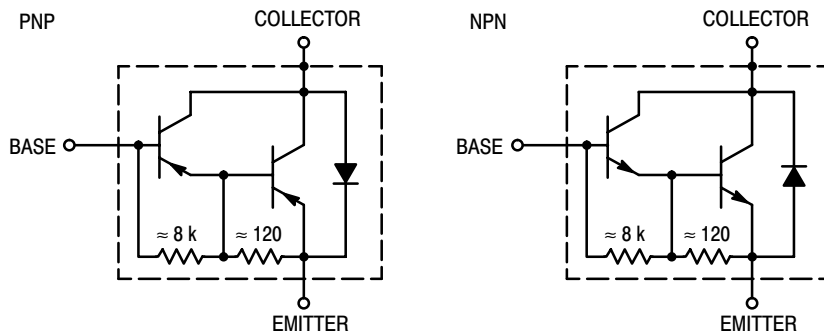
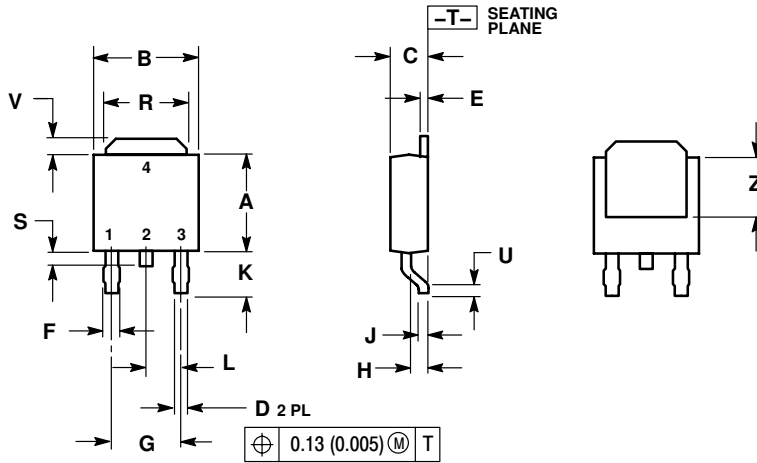

Figure 12. Darlington Schematic

MJD112 (NPN) MJD117 (PNP)

PACKAGE DIMENSIONS

DPAK CASE 369C ISSUE O



- NOTES:
 1. DIMENSIONING AND TOLERANCING PER ANSI Y14.5M, 1982.
 2. CONTROLLING DIMENSION: INCH.

DIM	INCHES		MILLIMETERS	
	MIN	MAX	MIN	MAX
A	0.235	0.245	5.97	6.22
B	0.250	0.265	6.35	6.73
C	0.086	0.094	2.19	2.38
D	0.027	0.035	0.69	0.88
E	0.018	0.023	0.46	0.58
F	0.037	0.045	0.94	1.14
G	0.180 BSC		4.58 BSC	
H	0.034	0.040	0.87	1.01
J	0.018	0.023	0.46	0.58
K	0.102	0.114	2.60	2.89
L	0.090 BSC		2.29 BSC	
R	0.180	0.215	4.57	5.45
S	0.025	0.040	0.63	1.01
U	0.020	---	0.51	---
V	0.035	0.050	0.89	1.27
Z	0.155	---	3.93	---

SOLDERING FOOTPRINT*

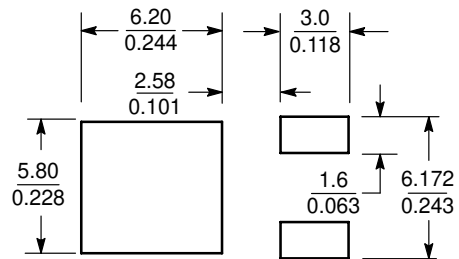

SCALE 3:1 $\left(\frac{\text{mm}}{\text{inches}}\right)$

*For additional information on our Pb-Free strategy and soldering details, please download the ON Semiconductor Soldering and Mounting Techniques Reference Manual, SOLDERRM/D.

MJD112 (NPN) MJD117 (PNP)

PACKAGE DIMENSIONS

DKPAK-3
CASE 369D-01
ISSUE B

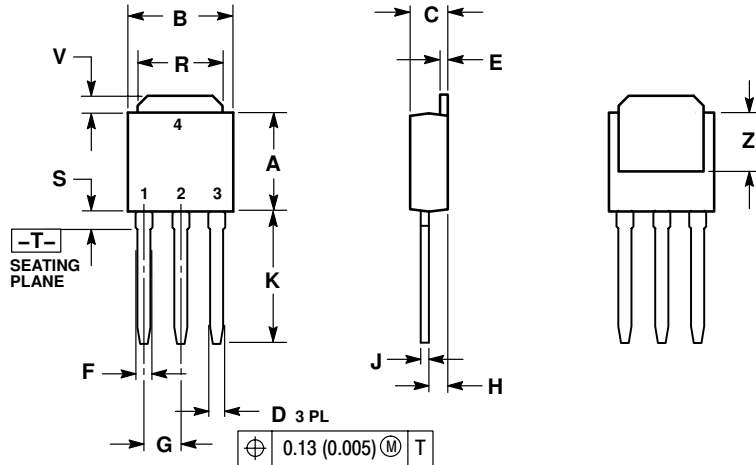

NOTES:

1. DIMENSIONING AND TOLERANCING PER ANSI Y14.5M, 1982.
2. CONTROLLING DIMENSION: INCH.

DIM	INCHES		MILLIMETERS	
	MIN	MAX	MIN	MAX
A	0.235	0.245	5.97	6.35
B	0.250	0.265	6.35	6.73
C	0.086	0.094	2.19	2.38
D	0.027	0.035	0.69	0.88
E	0.018	0.023	0.46	0.58
F	0.037	0.045	0.94	1.14
G	0.090 BSC		2.29 BSC	
H	0.034	0.040	0.87	1.01
J	0.018	0.023	0.46	0.58
K	0.350	0.380	8.89	9.65
R	0.180	0.215	4.45	5.45
S	0.025	0.040	0.63	1.01
V	0.035	0.050	0.89	1.27
Z	0.155	---	3.93	---

ON Semiconductor and are registered trademarks of Semiconductor Components Industries, LLC (SCILLC). SCILLC reserves the right to make changes without further notice to any products herein. SCILLC makes no warranty, representation or guarantee regarding the suitability of its products for any particular purpose, nor does SCILLC assume any liability arising out of the application or use of any product or circuit, and specifically disclaims any and all liability, including without limitation special, consequential or incidental damages. "Typical" parameters which may be provided in SCILLC data sheets and/or specifications can and do vary in different applications and actual performance may vary over time. All operating parameters, including "Typicals" must be validated for each customer application by customer's technical experts. SCILLC does not convey any license under its patent rights nor the rights of others. SCILLC products are not designed, intended, or authorized for use as components in systems intended for surgical implant into the body, or other applications intended to support or sustain life, or for any other application in which the failure of the SCILLC product could create a situation where personal injury or death may occur. Should Buyer purchase or use SCILLC products for any such unintended or unauthorized application, Buyer shall indemnify and hold SCILLC and its officers, employees, subsidiaries, affiliates, and distributors harmless against all claims, costs, damages, and expenses, and reasonable attorney fees arising out of, directly or indirectly, any claim of personal injury or death associated with such unintended or unauthorized use, even if such claim alleges that SCILLC was negligent regarding the design or manufacture of the part. SCILLC is an Equal Opportunity/Affirmative Action Employer. This literature is subject to all applicable copyright laws and is not for resale in any manner.

PUBLICATION ORDERING INFORMATION

LITERATURE FULFILLMENT:

Literature Distribution Center for ON Semiconductor
P.O. Box 61312, Phoenix, Arizona 85082-1312 USA
Phone: 480-829-7710 or 800-344-3860 Toll Free USA/Canada
Fax: 480-829-7709 or 800-344-3867 Toll Free USA/Canada
Email: orderlit@onsemi.com

N. American Technical Support: 800-282-9855 Toll Free USA/Canada

Japan: ON Semiconductor, Japan Customer Focus Center
2-9-1 Kamimeguro, Meguro-ku, Tokyo, Japan 153-0051
Phone: 81-3-5773-3850

ON Semiconductor Website: <http://onsemi.com>

Order Literature: <http://www.onsemi.com/litorder>

For additional information, please contact your local Sales Representative.

This datasheet has been download from:

www.datasheetcatalog.com

Datasheets for electronics components.