

Power Distribution Switch

Features

- 90mΩ High-Side MOSFET (G547E, G547F, G547G, G547H, G547M)
- Available with 5 Versions of Current Limits with Foldback
- Operating Range: 2.7V to 5.5V
- 1mS Typical Rise Time
- Fast Overcurrent Response -3μs (TYPICAL)
- Under voltage Lockout
- 100μA Quiescent Supply Current
- 1μA Maximum Shutdown Supply Current
- Logic Level Enable Pin, Available with Active-High or Active-Low Version
- No Reverse Current when Power Off
- Deglitched Open-Drain Over-Current Flag Output (\overline{OC})
- With Output Shutdown Pull-low Resistor
- SOT-23-6, SOP-8, MSOP-8 and TDFN3X3-8 Packages
- UL Approved #E232223
- Nemko IEC 60950-1 CB/CCA_scheme Certification Report #67291

General Description

The G547 is an integrated power switch for self-powered and bus-powered Universal Serial Bus (USB) applications. G547E, G547F, G547G, G547H and G547M are 90mΩ $R_{DS(ON)}$.

Several Protection features include current limiting with foldback, and thermal shutdown to prevent catastrophic switch failure caused by increasing power dissipation when continuous heavy loads or short circuit occurs. A built-in charge pump is used to drive the N-channel MOSFET that is free of parasitic body diode to eliminate any reversed current flow across the switch when it is powered off.

\overline{OC} is open-drain output report over-current or over-temperature event and has typical 9ms deglitch timeout period.

Applications

- High-Side Power Protection Switch
- USB Power Management
- USB Host and Self-Powered Bubs
- USB Bus-Powered Hubs
- Hot Plug-In Power Supplies
- Battery-Charger Circuits

Pin Configuration

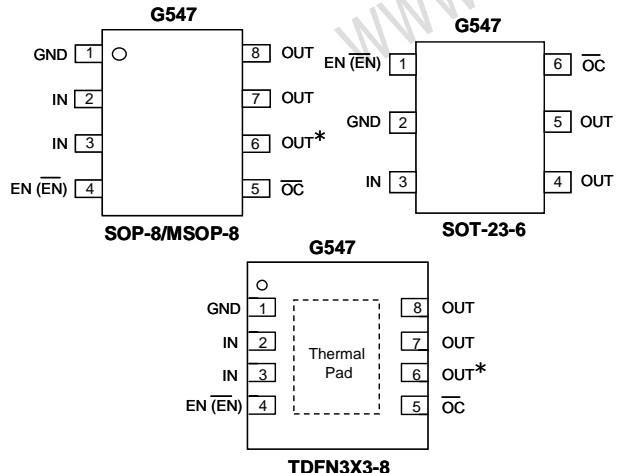

Note: Recommend connecting the Thermal Pad to the GND for excellent power dissipation.

*Pin#6 should be considered as OUT when circuit design and PCB layout, but it is NC pin actually.

Typical Application Circuit

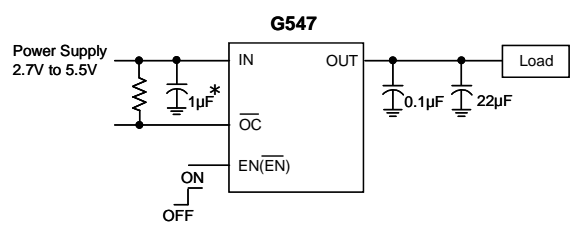

*: 1μF of input capacitor is enough in most application cases. If the PCB trace of power rail to IN is long, larger input capacitor is necessary.



Ordering Information

ORDER NUMBER	MARKING	ENABLE	Current Limit	Output MOS $R_{DS(ON)}$	Output Shutdown Resistor	TEMP. RANGE	PACKAGE (Green)
G547E1TB1U	57EAx	Active High	2.5A	90mΩ	Yes	-40°C to +85°C	SOT-23-6
G547E2TB1U	57EBx	Active Low	2.5A	90mΩ	Yes	-40°C to +85°C	SOT-23-6
G547F1TB1U	57FAx	Active High	2A	90mΩ	Yes	-40°C to +85°C	SOT-23-6
G547F2TB1U	57FBx	Active Low	2A	90mΩ	Yes	-40°C to +85°C	SOT-23-6
G547G1TB1U	57GAx	Active High	1.5A	90mΩ	Yes	-40°C to +85°C	SOT-23-6
G547G2TB1U	57GBx	Active Low	1.5A	90mΩ	Yes	-40°C to +85°C	SOT-23-6
G547H1TB1U	57HAx	Active High	1A	90mΩ	Yes	-40°C to +85°C	SOT-23-6
G547H2TB1U	57HBx	Active Low	1A	90mΩ	Yes	-40°C to +85°C	SOT-23-6
G547M1TB1U	57MAx	Active High	3.7A	90mΩ	Yes	-40°C to +85°C	SOT-23-6
G547M2TB1U	57MBx	Active Low	3.7A	90mΩ	Yes	-40°C to +85°C	SOT-23-6
G547E1P11U	G547E1	Active High	2.5A	90mΩ	Yes	-40°C to +85°C	SOP-8
G547E2P11U	G547E2	Active Low	2.5A	90mΩ	Yes	-40°C to +85°C	SOP-8
G547F1P11U	G547F1	Active High	2A	90mΩ	Yes	-40°C to +85°C	SOP-8
G547F2P11U	G547F2	Active Low	2A	90mΩ	Yes	-40°C to +85°C	SOP-8
G547G1P11U	G547G1	Active High	1.5A	90mΩ	Yes	-40°C to +85°C	SOP-8
G547G2P11U	G547G2	Active Low	1.5A	90mΩ	Yes	-40°C to +85°C	SOP-8
G547H1P11U	G547H1	Active High	1A	90mΩ	Yes	-40°C to +85°C	SOP-8
G547H2P11U	G547H2	Active Low	1A	90mΩ	Yes	-40°C to +85°C	SOP-8
G547M1P11U	G547M1	Active High	3.7A	90mΩ	Yes	-40°C to +85°C	SOP-8
G547M2P11U	G547M2	Active Low	3.7A	90mΩ	Yes	-40°C to +85°C	SOP-8
G547E1P81U	G547E1	Active High	2.5A	90mΩ	Yes	-40°C to +85°C	MSOP-8
G547E2P81U	G547E2	Active Low	2.5A	90mΩ	Yes	-40°C to +85°C	MSOP-8
G547F1P81U	G547F1	Active High	2A	90mΩ	Yes	-40°C to +85°C	MSOP-8
G547F2P81U	G547F2	Active Low	2A	90mΩ	Yes	-40°C to +85°C	MSOP-8
G547G1P81U	G547G1	Active High	1.5A	90mΩ	Yes	-40°C to +85°C	MSOP-8
G547G2P81U	G547G2	Active Low	1.5A	90mΩ	Yes	-40°C to +85°C	MSOP-8
G547H1P81U	G547H1	Active High	1A	90mΩ	Yes	-40°C to +85°C	MSOP-8
G547H2P81U	G547H2	Active Low	1A	90mΩ	Yes	-40°C to +85°C	MSOP-8
G547M1P81U	G547M1	Active High	3.7A	90mΩ	Yes	-40°C to +85°C	MSOP-8
G547M2P81U	G547M2	Active Low	3.7A	90mΩ	Yes	-40°C to +85°C	MSOP-8
G547E1RD1U	547E1	Active High	2.5A	90mΩ	Yes	-40°C to +85°C	TDFN3X3-8
G547E2RD1U	547E2	Active Low	2.5A	90mΩ	Yes	-40°C to +85°C	TDFN3X3-8
G547F1RD1U	547F1	Active High	2A	90mΩ	Yes	-40°C to +85°C	TDFN3X3-8
G547F2RD1U	547F2	Active Low	2A	90mΩ	Yes	-40°C to +85°C	TDFN3X3-8
G547G1RD1U	547G1	Active High	1.5A	90mΩ	Yes	-40°C to +85°C	TDFN3X3-8
G547G2RD1U	547G2	Active Low	1.5A	90mΩ	Yes	-40°C to +85°C	TDFN3X3-8
G547H1RD1U	547H1	Active High	1A	90mΩ	Yes	-40°C to +85°C	TDFN3X3-8
G547H2RD1U	547H2	Active Low	1A	90mΩ	Yes	-40°C to +85°C	TDFN3X3-8
G547M1RD1U	547M1	Active High	3.7A	90mΩ	Yes	-40°C to +85°C	TDFN3X3-8
G547M2RD1U	547M2	Active Low	3.7A	90mΩ	Yes	-40°C to +85°C	TDFN3X3-8

Note: TB: SOT-23-6 P1: SOP-8 P8: MSOP-8 RD: TDFN3X3-8

1: Bonding Code

U: Tape & Reel

Absolute Maximum Ratings

Supply Voltage (V_{IN})	.6V
Output Voltage (V_{OUT})	.6V
Output Current (I_{OUT})	Internally Limited
Enable Input (V_{EN})	-0.3V to 6V
Thermal Resistance Junction to Ambient, (θ_{JA})*	
SOT-23-6	250°C/W
SOP-8	160°C/W
MSOP-8	180°C/W
TDFN3X3-8	170°C/W
Continuous Power Dissipation ($T_A = +25^\circ\text{C}$)*	
SOT-23-6	0.5W

SOP-8	.071W
MSOP-8	.064W
TDFN3X3-8	0.67W
Junction Temperature	150°C
Storage Temperature (T_S)	-65°C to +150°C
Reflow Temperature (soldering, 10sec)	260°C
ESD Protection	2kV

Operating Ratings

Supply Voltage (V_{IN})	3V to 5.5V
Operating Temperature (T_A)	-40°C to +85°C

*Please refer to Minimum Footprint PCB Layout Section.

Electrical Characteristics

$V_{IN} = 5V$, $C_{IN} = 1\mu F$, $C_{OUT} = 1\mu F$, $R_L = 10\Omega$, $T_A = 25^\circ\text{C}$.

The device is not guaranteed to function outside its operating conditions. Parameters with MIN and/or MAX limits are 100% tested at +25°C, unless otherwise specified.

PARAMETER	CONDITION	MIN	TYP	MAX	UNITS
Input Voltage Range		2.7	---	5.5	V
Output MOS $R_{DS(ON)}$	G547E1/G547E2, $I_{OUT} = 2A$	---	90	110	m Ω
	G547F1/G547F2, $I_{OUT} = 1.5A$				
	G547G1/G547G2, $I_{OUT} = 1A$				
	G547H1/G547H2, $I_{OUT} = 0.5A$				
	G547M1/G547M2, $I_{OUT} = 2.5A$				
Supply Current		---	100	135	μA
Output Turn-on Rising Time	$R_L = 10\Omega$, 90% Settling	0.4	1	1.5	ms
Current Limit Threshold	G547E1/G547E2, $V_{OUT} = 4V$	2.01	2.5	3	A
	G547F1/G547F2, $V_{OUT} = 4V$				
	G547G1/G547G2, $V_{OUT} = 4V$				
	G547H1/G547H2, $V_{OUT} = 4V$				
	G547M1/G547M2, $V_{OUT} = 4V$				
Short-circuit Current	G547E1/G547E2, $V_{OUT} = 0V$, $2.7V < V_{IN} < 5.5V$	0.2	1.7	2.6	A
	G547F1/G547F2, $V_{OUT} = 0V$, $2.7V < V_{IN} < 5.5V$				
	G547G1/G547G2, $V_{OUT} = 0V$, $2.7V < V_{IN} < 5.5V$				
	G547H1/G547H2, $V_{OUT} = 0V$, $2.7V < V_{IN} < 5.5V$				
	G547M1/G547M2, $V_{OUT} = 0V$, $2.7V < V_{IN} < 5.5V$				
EN Input Threshold-High V_{IH}		1.4	1.6	1.8	V
EN Input Threshold-Low V_{IL}		0.8	1.3	1.6	V
Shutdown Supply Current		---	0.1	1	μA
Shutdown Pull Low Resistance		---	75	150	Ω
Output Leakage Current	EN="0", $V_{OUT} = 0V$	---	0.5	1	μA
V_{IN} Under Voltage Lockout		2.2	2.5	2.7	V
V_{IN} Under Voltage Hysteresis		---	200	---	mV
Thermal Limit		---	135	---	$^\circ\text{C}$
Thermal Limit Hysteresis		---	20	---	$^\circ\text{C}$
\overline{OC} Deglitch	\overline{OC} assertion or deassertion	4	9	15	ms
\overline{OC} Output Low Voltage	$I_{\overline{OC}} = 2mA$	---	---	0.4	V
\overline{OC} Off-State Current	$V_{\overline{OC}} = 5V$	---	---	1	μA
t_S Response Time to Short Circuit	$V_{IN} = 5V$, see figure 1.	---	3	---	μs

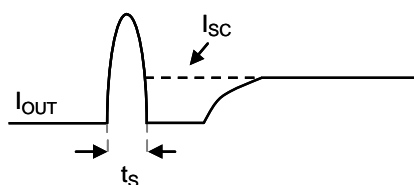
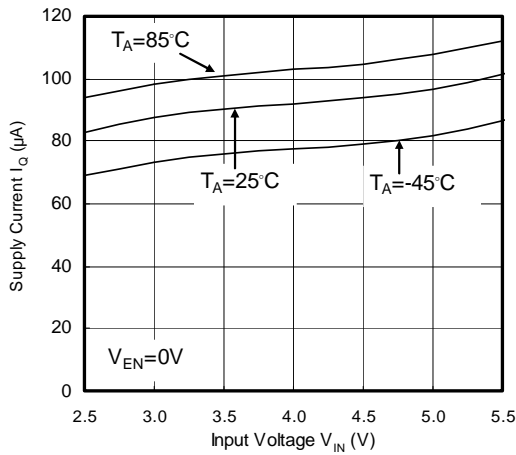

Figure 1

Typical Performance Characteristics

($V_{IN}=5V$, $C_{IN}=1\mu F$, $C_{OUT}=1\mu F$, $V_{EN}=0V$, $T_A=25^\circ C$, test by G547F1, unless otherwise noted.)

Supply Current vs. Input Voltage



Shutdown Supply Current vs. Input Voltage

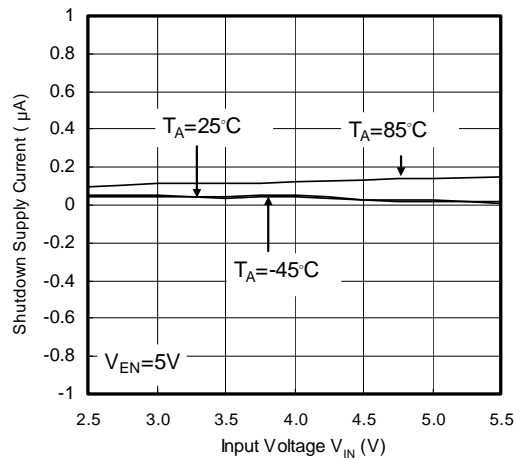

Enable Input Threshold vs. Input Voltage

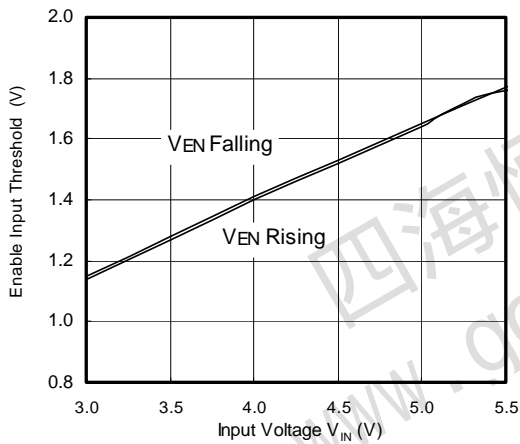

Enable Input Threshold vs. Temperature

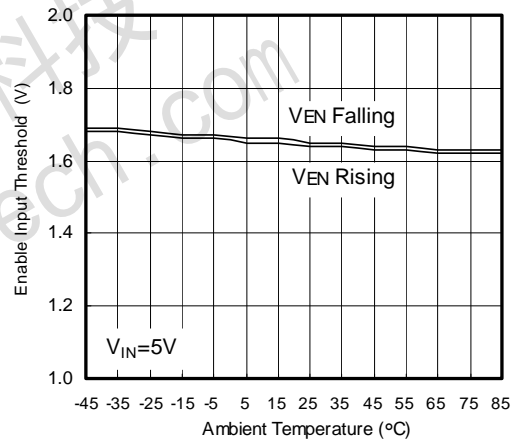

OC Deglitch Time vs. Input Voltage

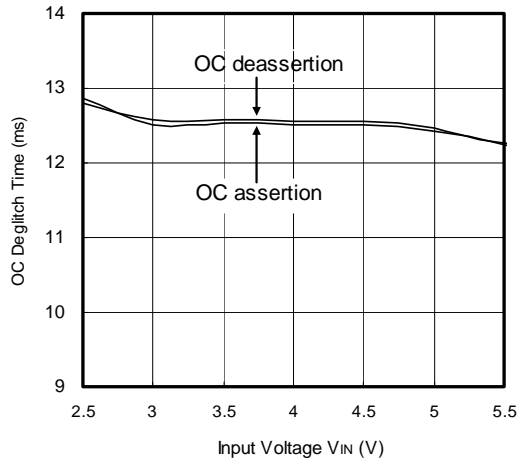

UVLO Threshold vs. Temperature

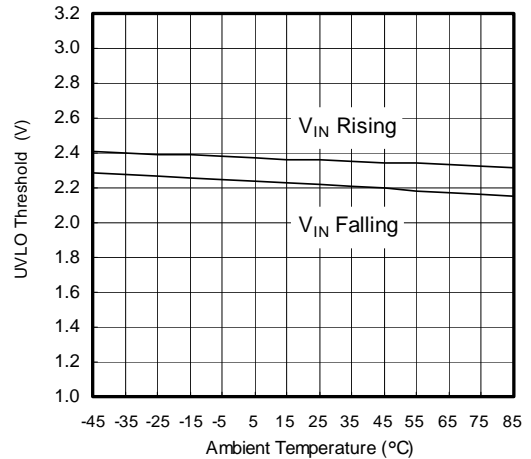

Typical Performance Characteristics (continued)

ON-Resistance vs. Input Voltage

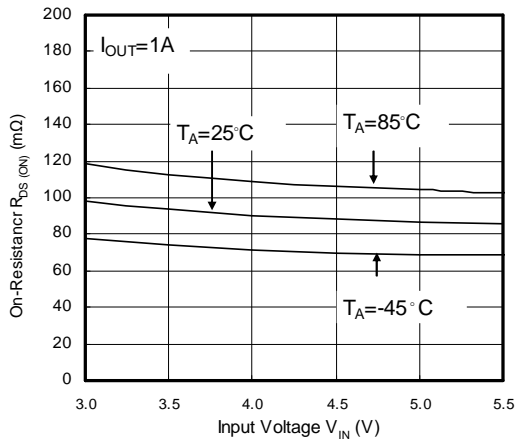

ON-Resistance vs. Temperature

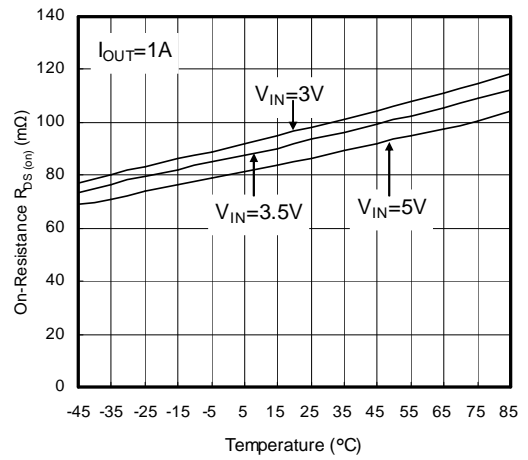

Current Limit Threshold vs. Input Voltage

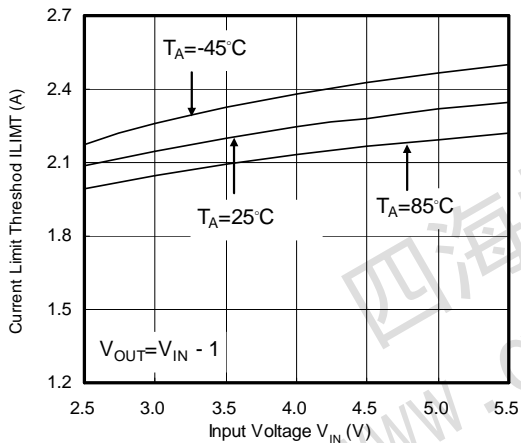

Short Circuit Current vs. Input Voltage

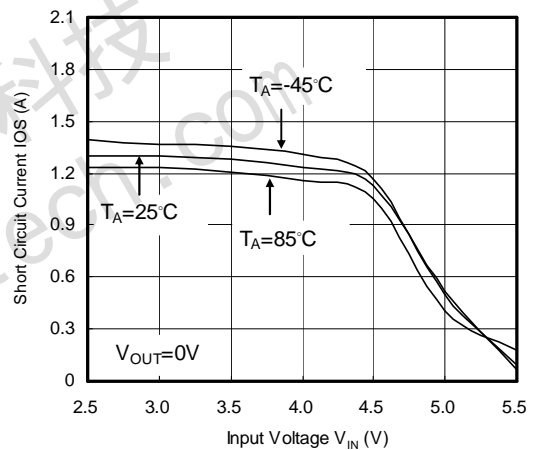

Overcurrent Protection Characteristics

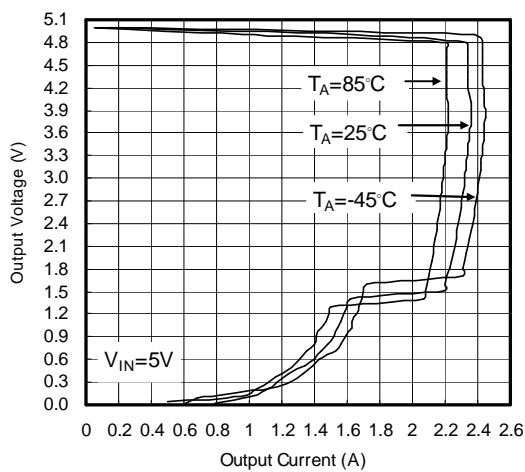

Overcurrent Protection Characteristics

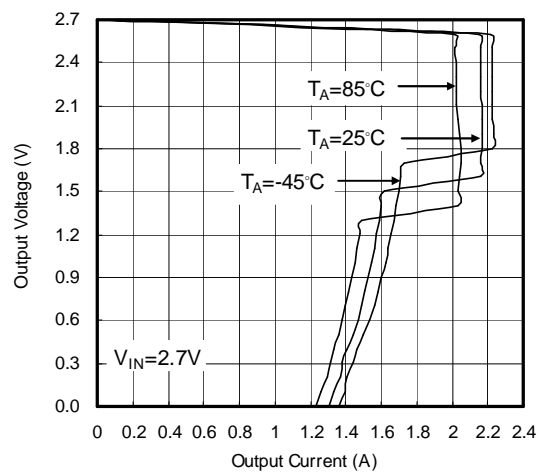

Typical Performance Characteristics (continued)

Turn on Delay Time and Rise Time

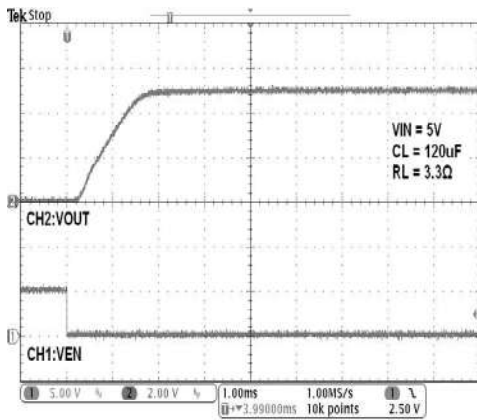

Turn off Delay Time and Fall Time

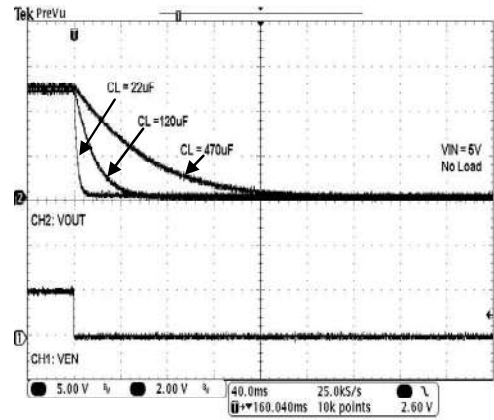

Inrush Current With Different Load Capacitance

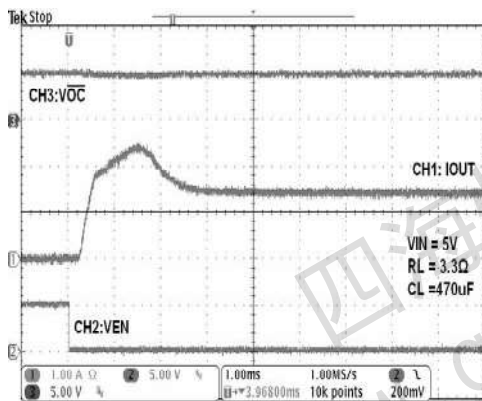

Thermal Shutdown Response

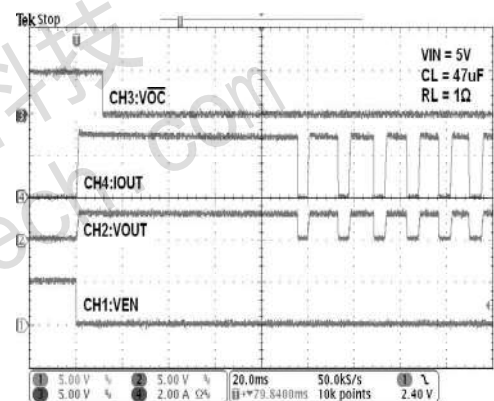

UVLO Protection at Rising

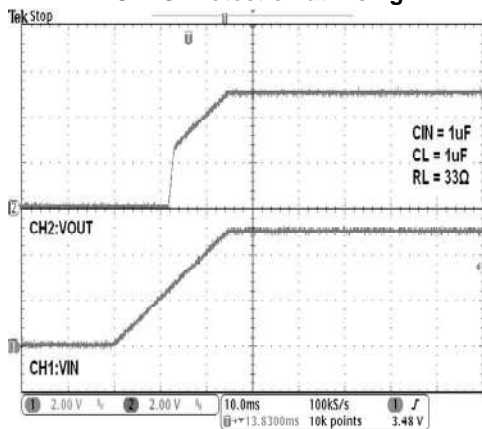

UVLO Protection at Falling

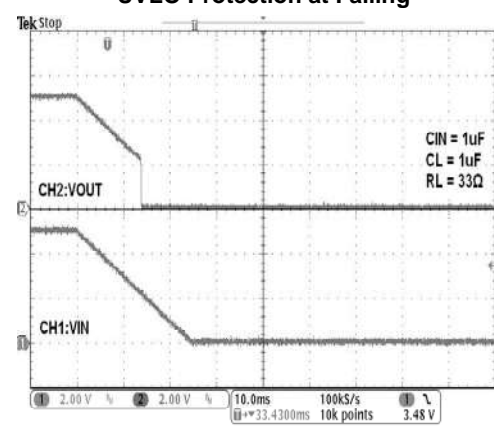

Typical Performance Characteristics (continued)

Inrush Short Circuit Response

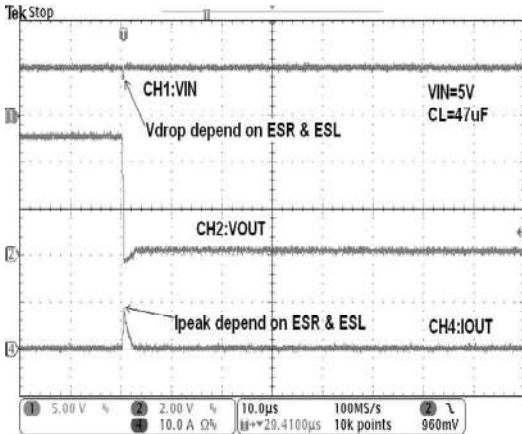

Short Circuit Response at Start up

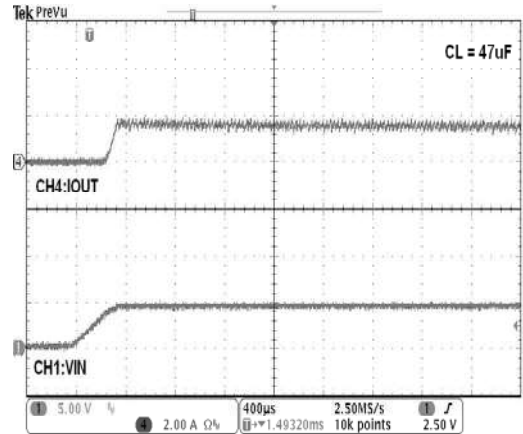

Short-Circuit Current, Device Enable into Short

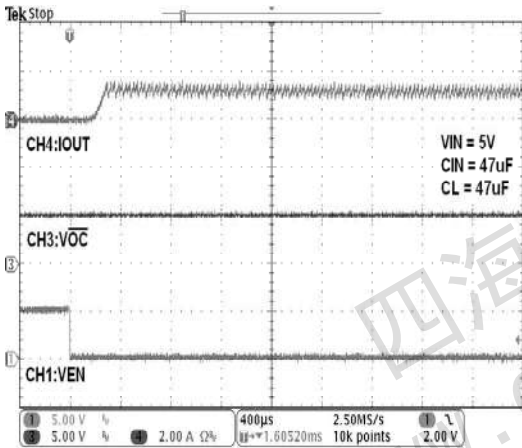

Resistance Load Inrush Response

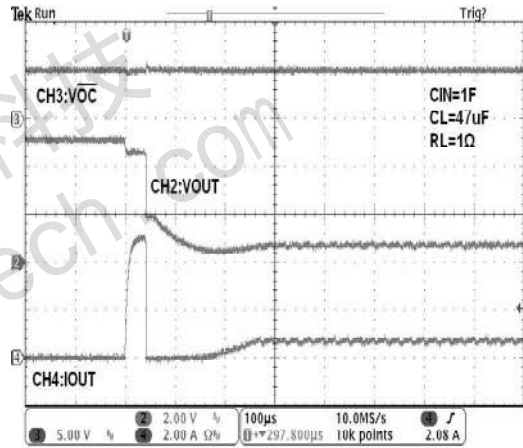

Capacitance Load Inrush Response

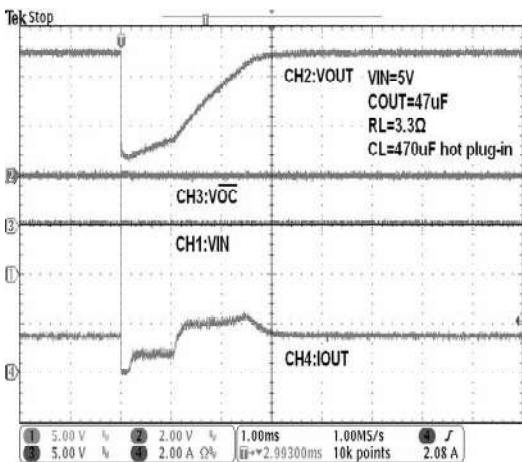

Capacitance Load Inrush Response

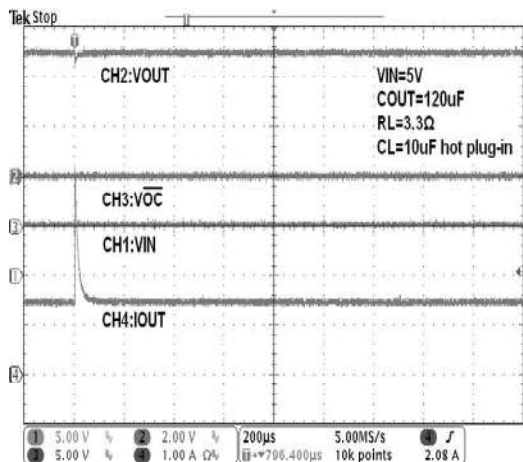

Minimum Footprint PCB Layout Section

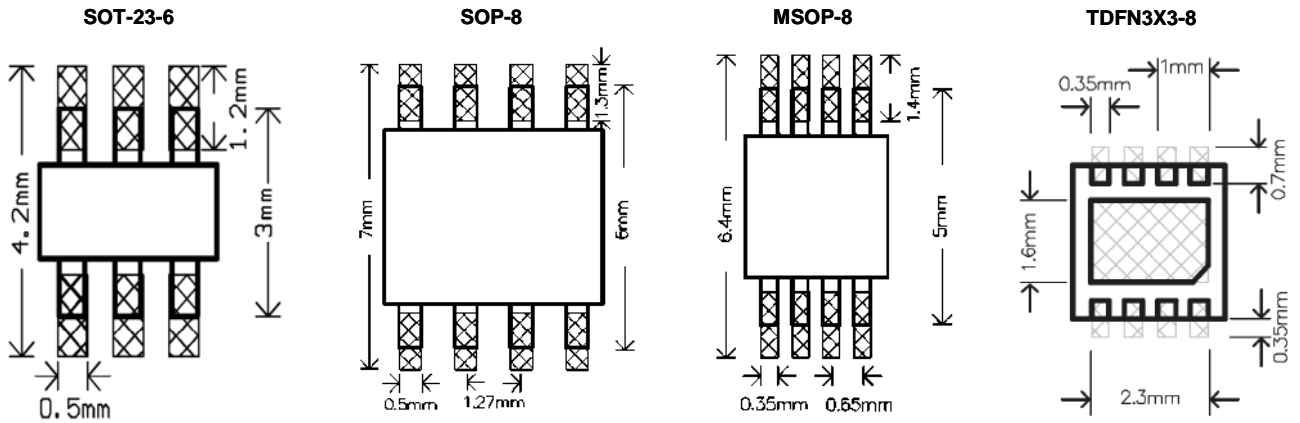

四海恒通科技
www.gofotech.com

Pin Description

PIN			NAME	PIN FUNCTION
SOT-23-6	SOP-8/MSOP-8	TDFN3X3-8		
2	1	1	GND	Ground
3	2,3	2,3	IN	Input Supply: Output MOSFET Drain, which also supplies IC's internal circuitry. Connect to positive supply.
1	4	4	EN($\overline{\text{EN}}$)	Enable: Logic level enable input. Make sure EN pin never floating.
6	5	5	$\overline{\text{OC}}$	Over-Current: Open-Drain $\overline{\text{OC}}$ output.
4,5	6,7,8	6,7,8	OUT	Switch Output: Output MOSFET Source of switch. Typically connect to switched side of load.
		Thermal Pad		Recommend connecting the Thermal Pad to the GND for excellent power dissipation.

Block Diagram

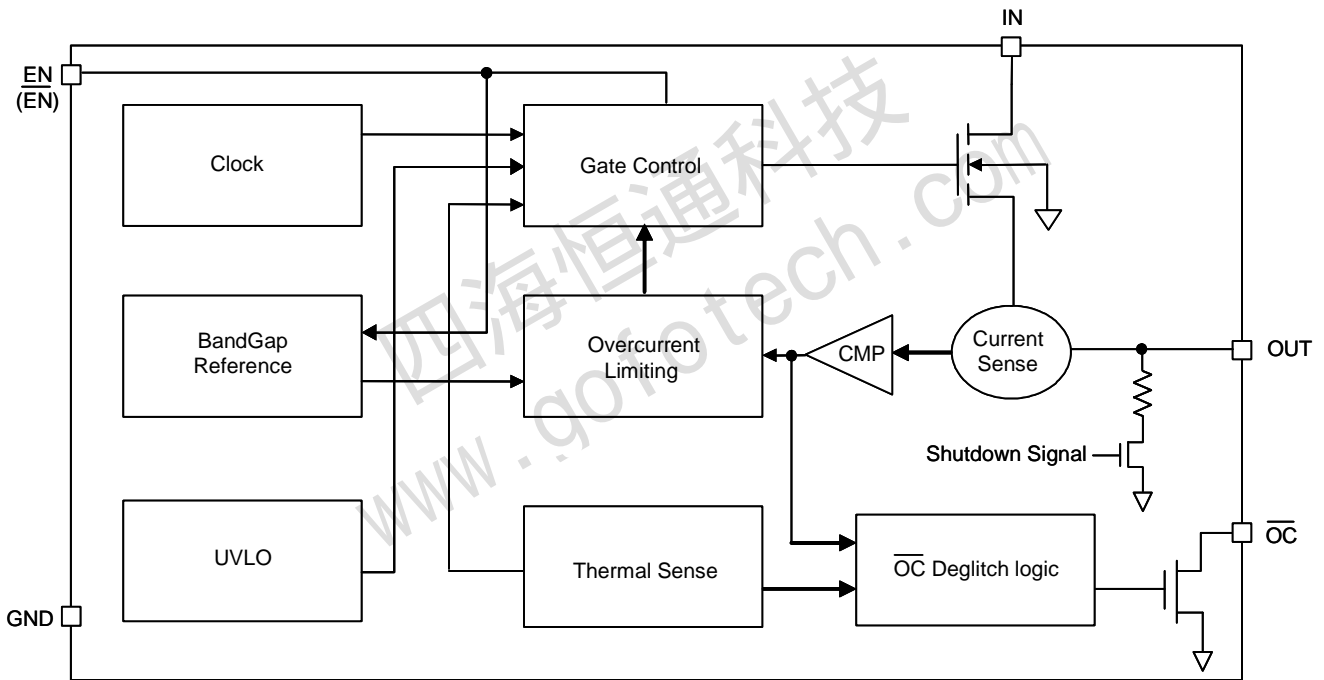

Functional Description

Input and Output

IN (input) is the power supply connection to the logic circuitry and the drain of the output MOSFET. OUT (output) is the source of the output MOSFET. In a typical application, current flows through the switch from IN to OUT toward the load. Both OUT pins must be connected together to the load.

Thermal Shutdown

Thermal shutdown protects G547 from excessive power dissipation. If the die temperature exceeds 135°C, the MOSFETS switch is shut off. 20°C of hysteresis prevents the switch from turning on until the die temperature drops to 115°C. Thermal shutdown circuit functions only when the switch is enabled.

Undervoltage Lockout

UVLO (undervoltage lockout) prevents the output MOSFET from turning on until IN (input voltage) exceeds 2.5V typically. After the switch turns on, if the voltage drops below 2.3V typically, UVLO shuts off the output MOSFET.

Current Limiting

The typical current limit value of G547 is 3.7A, 2.5A, 2A, 1.5A, 1A. There is foldback of current limit when $V_{OUT} < 1.5V$ (See Typical Performance Characteristics).

\overline{OC} Function

The \overline{OC} open-drain output is asserted (active low) when an over current or overtemperature shutdown condition is encountered after a 9-ms deglitch timeout. The output remains asserted until the overcurrent or overtemperature condition is removed.

Applications Information

Supply Filtering

A 1 μ F bypass capacitor from IN to GND, located near the G547, is strongly recommended to control supply transients. Without a bypass capacitor, an output short may cause sufficient ringing on the input (from supply lead inductance) to damage internal control circuitry.

Input transients must not exceed the absolute maximum supply voltage ($V_{IN\ max} = 6V$) even for a short duration.

EN, the Enable Input

EN must be driven logic high or logic low for a clearly defined input. Floating the input may cause unpredictable operation. EN should not be allowed to go negative with respect to GND.

Test Circuit

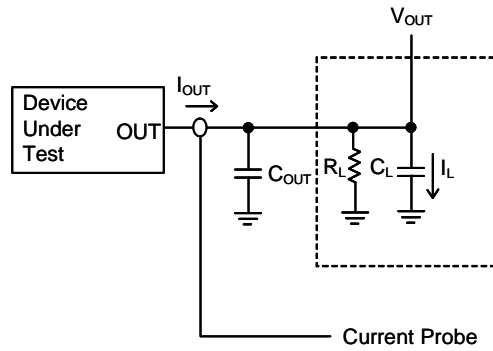

Timing Diagrams

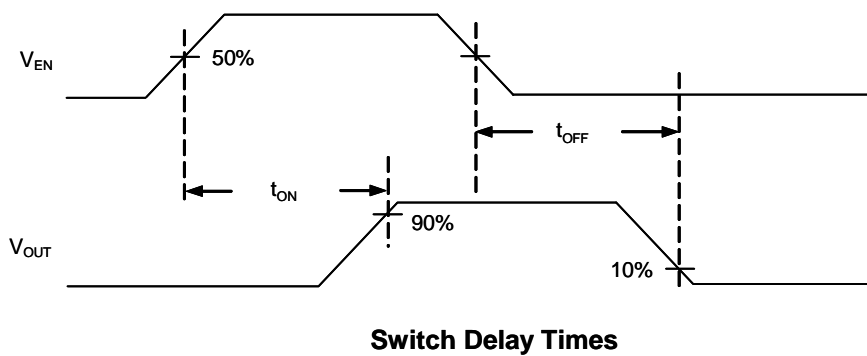
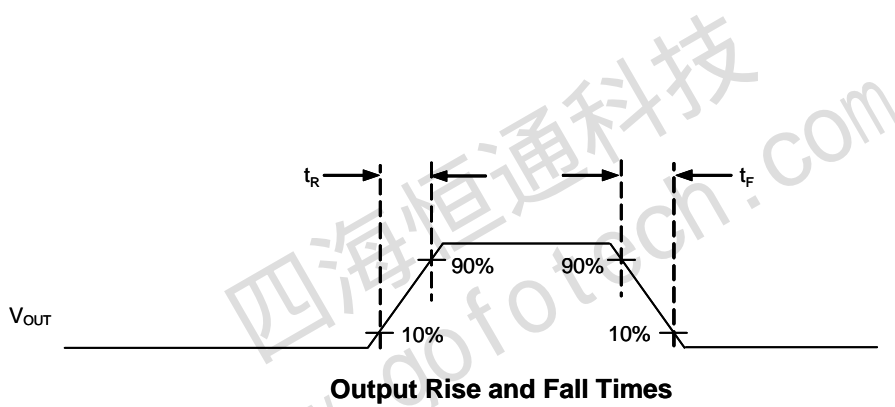

Package Information

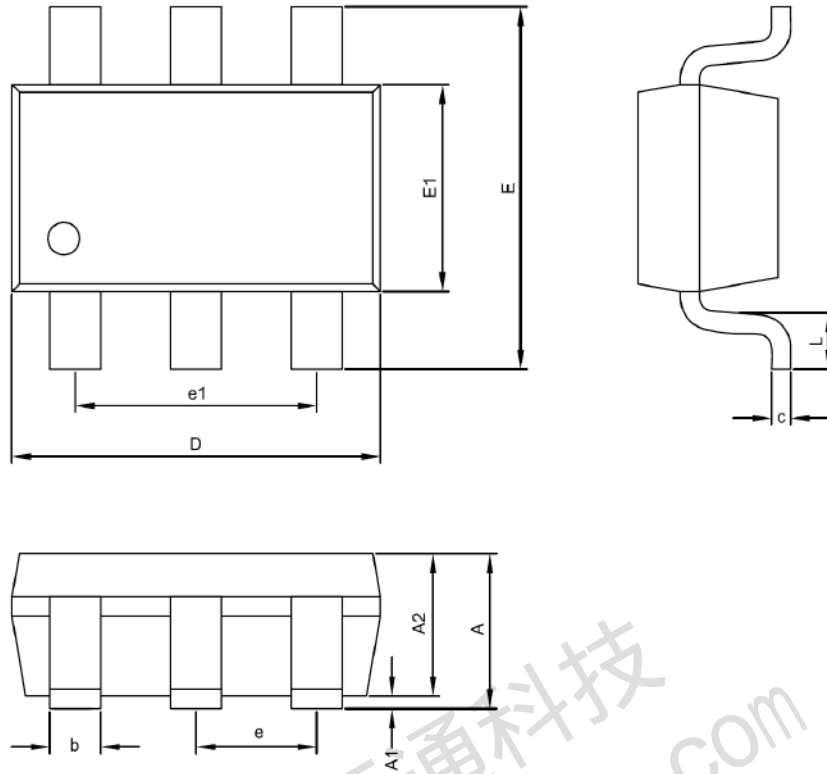

SOT-23-6 Package

Symble	DIMENSION IN MM			DIMENSION IN INCH		
	MIN.	NOM.	MAX.	MIN.	NOM.	MAX.
A	1.00	1.10	1.45	0.039	0.043	0.057
A1	0.00	---	0.15	0.000	---	0.006
A2	1.00	1.10	1.30	0.039	0.043	0.051
D	2.70	2.90	3.10	0.106	0.114	0.122
E	2.60	2.80	3.00	0.102	0.110	0.118
E1	1.50	1.60	1.70	0.059	0.063	0.067
c	0.08	0.15	0.25	0.003	0.006	0.010
b	0.30	0.40	0.50	0.012	0.016	0.020
e	0.95 BSC			0.037 BSC		
e1	1.90 BSC			0.075 BSC		
L	0.30	0.45	0.60	0.012	0.018	0.024

Taping Specification

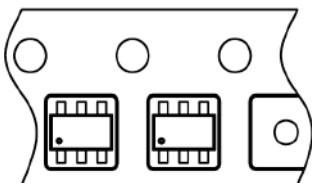

PACKAGE	Q'TY/REEL
SOT-23-6	3,000 ea

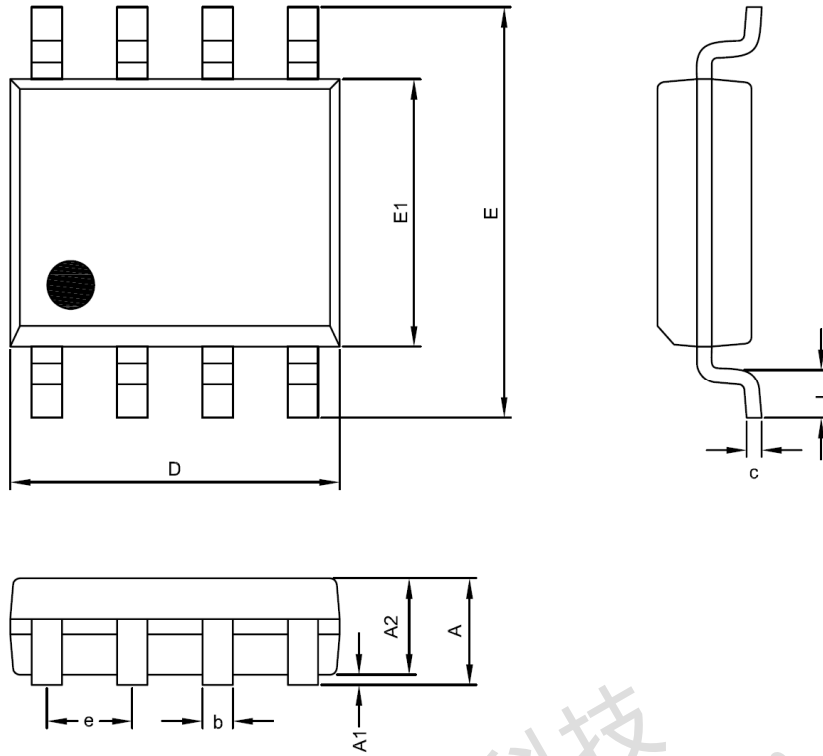

SOP-8 Package

Symble	DIMENSION IN MM			DIMENSION IN INCH		
	MIN.	NOM.	MAX.	MIN.	NOM.	MAX.
A	1.35	1.55	1.75	0.053	0.061	0.069
A1	0.00	---	0.25	0.000	---	0.010
A2	1.15	1.35	1.50	0.045	0.053	0.059
D	4.80	4.90	5.00	0.189	0.192	0.197
E	5.80	6.00	6.20	0.228	0.236	0.244
E1	3.80	3.90	4.00	0.150	0.153	0.157
c	0.19	0.23	0.27	0.007	0.009	0.011
b	0.33	0.43	0.53	0.013	0.017	0.021
e	1.27 BSC			0.050 BSC		
L	0.40	0.7	1.00	0.016	0.028	0.039

Taping Specification

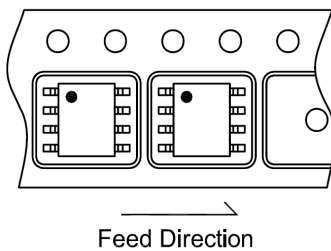

PACKAGE	Q'TY/REEL
SOP-8	2,500 ea

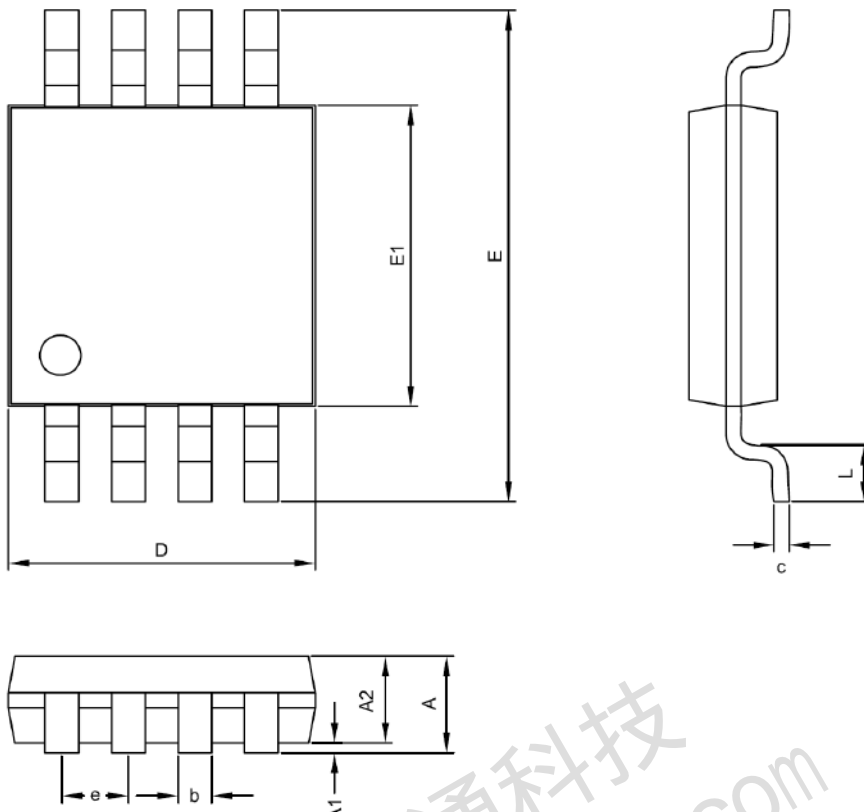

MSOP-8 Package

Symble	DIMENSION IN MM			DIMENSION IN INCH		
	MIN.	NOM.	MAX.	MIN.	NOM.	MAX.
A	0.81	0.95	1.10	0.032	0.037	0.043
A1	0.00	---	0.15	0.000	---	0.006
A2	0.76	0.86	0.96	0.030	0.034	0.038
D	2.85	3.00	3.15	0.112	0.118	0.124
E	4.75	4.90	5.05	0.187	0.193	0.199
E1	2.85	3.00	3.15	0.112	0.118	0.124
c	0.13	0.15	0.23	0.005	0.006	0.009
b	0.28	0.30	0.38	0.011	0.012	0.015
e	0.65 BSC			0.026 BSC		
L	0.4	0.53	0.8	0.016	0.021	0.031

Taping Specification

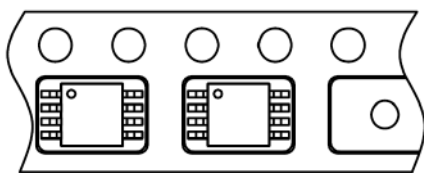

Feed Direction

PACKAGE	Q'TY/REEL
MSOP-8	3,000 ea

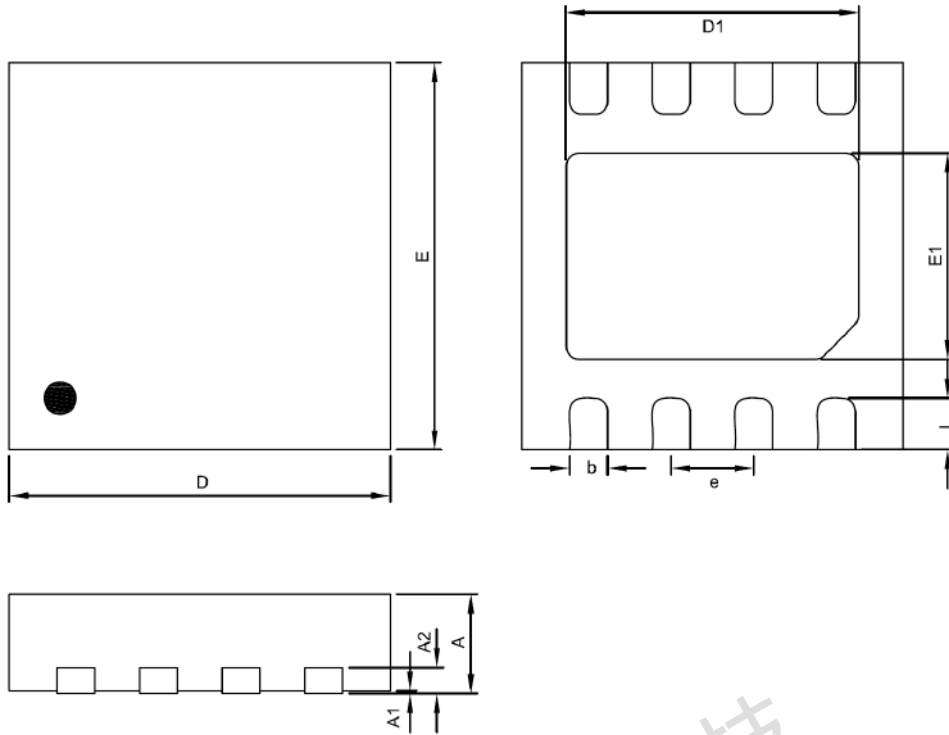
TDFN3X3-8 Package

Symble	DIMENSION IN MM			DIMENSION IN INCH		
	MIN.	NOM.	MAX.	MIN.	NOM.	MAX.
A	0.70	0.75	0.80	0.0276	0.0295	0.0315
A1	0.00	---	0.05	0.0000	---	0.0020
A2	0.19	0.20	0.21	0.0075	0.0079	0.0083
D	2.95	3.00	3.05	0.1161	0.1181	0.1201
E	2.95	3.00	3.05	0.1161	0.1181	0.1201
D1	2.20	2.30	2.40	0.0866	0.0906	0.0945
E1	1.40	1.50	1.60	0.0551	0.0591	0.0630
b	0.25	0.30	0.35	0.0098	0.0118	0.0138
e	0.65 BSC			0.0256 BSC		
L	0.30	0.35	0.45	0.0118	0.0138	0.0177

Taping Specification

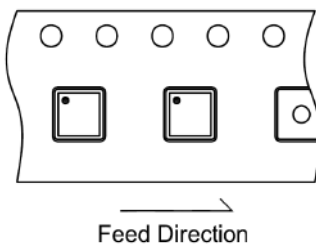

PACKAGE	Q'TY/REEL
TDFN3X3-8	3,000 ea

GMT Inc. does not assume any responsibility for use of any circuitry described, no circuit patent licenses are implied and GMT Inc. reserves the right at any time without notice to change said circuitry and specifications.