

TA7233P

T-74-05-01

## TENTATIVE

## DUAL AUDIO POWER AMPLIFIER.

The TA7233P is a dual audio power amplifier for consumer applications.

It is suitable for power amplifier of portable stereo radio cassette and stereo receiver.

## . High Power:

$$P_{OUT(1)} = 4.5W(\text{Typ.})/\text{CH}$$

( $V_{CC}=12V$ ,  $f=1\text{kHz}$ ,  $\text{THD}=10\%$ ,  $R_L=4\Omega$ )

$$P_{OUT(2)} = 2.5W(\text{Typ.})/\text{CH}$$

( $V_{CC}=9V$ ,  $f=1\text{kHz}$ ,  $\text{THD}=10\%$ ,  $R_L=4\Omega$ )

## . Low Supply Current

$$I_{CCQ} = 35\text{mA}(\text{Typ.}) \quad (V_{CC}=12V, V_{in}=0)$$

## . Thermal Shut Down Protector

## . Audio Muting Function

. Operating Supply Voltage :  $V_{CC(\text{opr})}=6 \sim 12V$ 

Unit in mm

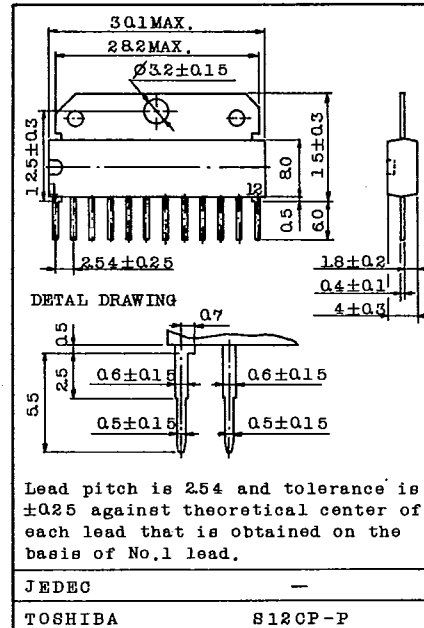
MAXIMUM RATINGS ( $T_a=25^\circ\text{C}$ )

CHARACTERISTIC	SYMBOL	RATING	UNIT
Supply Voltage	$V_{CC}$	16	V
Output Current (Peak/CH)	$I_O(\text{peak})$	2.5	A
Power Dissipation	$P_D$	12.5	W
Operating Temperature	$T_{opr}$	-20 ~ 75	$^\circ\text{C}$
Storage Temperature	$T_{stg}$	-55 ~ 150	$^\circ\text{C}$

AUDIO LINEAR IC

9097247 TOSHIBA. ELECTRONIC

02E 16935 D

**TA7233P**

T-74-05-01

## ELECTRICAL CHARACTERISTICS

(Unless otherwise specified,  $V_{CC}=12V$ ,  $R_L=4\Omega$ ,  $R_g=600\Omega$ ,  $f=1kHz$ ,  $T_a=25^\circ C$ )

CHARACTERISTIC	SYMBOL	TEST CIR-CUIT	TEST CONDITION	MIN.	TYP.	MAX.	UNIT
Quiescent Current	$I_{CCQ}$		$V_{in}=0$	-	35	60	mA
Output Power	$P_{OUT(1)}$		THD=10%	3.8	4.5	-	W
	$P_{OUT(2)}$		THD=10%, $V_{CC}=9V$	2.0	2.5	-	
Total Harmonic Distortion	THD		$P_{OUT}=1W/CH.$	-	0.1	0.8	%
Voltage Gain	$G_V(1)$		$R_f=150\Omega$ $V_{OUT}=0.775V_{rms}$	43	45	47	dB
	$G_V(2)$		$R_f=0$ , $V_{OUT}=0.775V_{rms}$	-	57	-	
Input Resistance	$R_{IN}$		-	-	30	-	k $\Omega$
Output Noise Voltage	$V_{NO}$		$R_g=10k\Omega$ $BW=20Hz \sim 20kHz$	-	0.4	0.7	mV $_{rms}$
Ripple Rejection Ratio	R.R.		$R_g=600\Omega$ $f_{ripple}=100Hz$	-	45	-	dB
Cross Talk	CT		$R_g=10k\Omega$ , Ampl $\leftrightarrow$ 2 $V_{OUT}=0dBm$ , $f=1kHz$	-	60	-	dB
Input Offset Voltage	$V_5, V_7$		-	-	35	60	mV

## TYPICAL DC VOLTAGE OF EACH TERMINAL

 $(V_{CC}=12V, T_a=25^\circ C)$ 

TERMINAL No.	1	2	3	4	5	6	7	8	9	10	11	12
DC Voltage (V)	11.5	6	6.7	0.7	0.035	GND	0.035	0.7	GND	6	11.5	$V_{CC}$

**TOSHIBA**

# TA7233P

T-74-05-01

## BLOCK DIAGRAM, TEST CIRCUIT

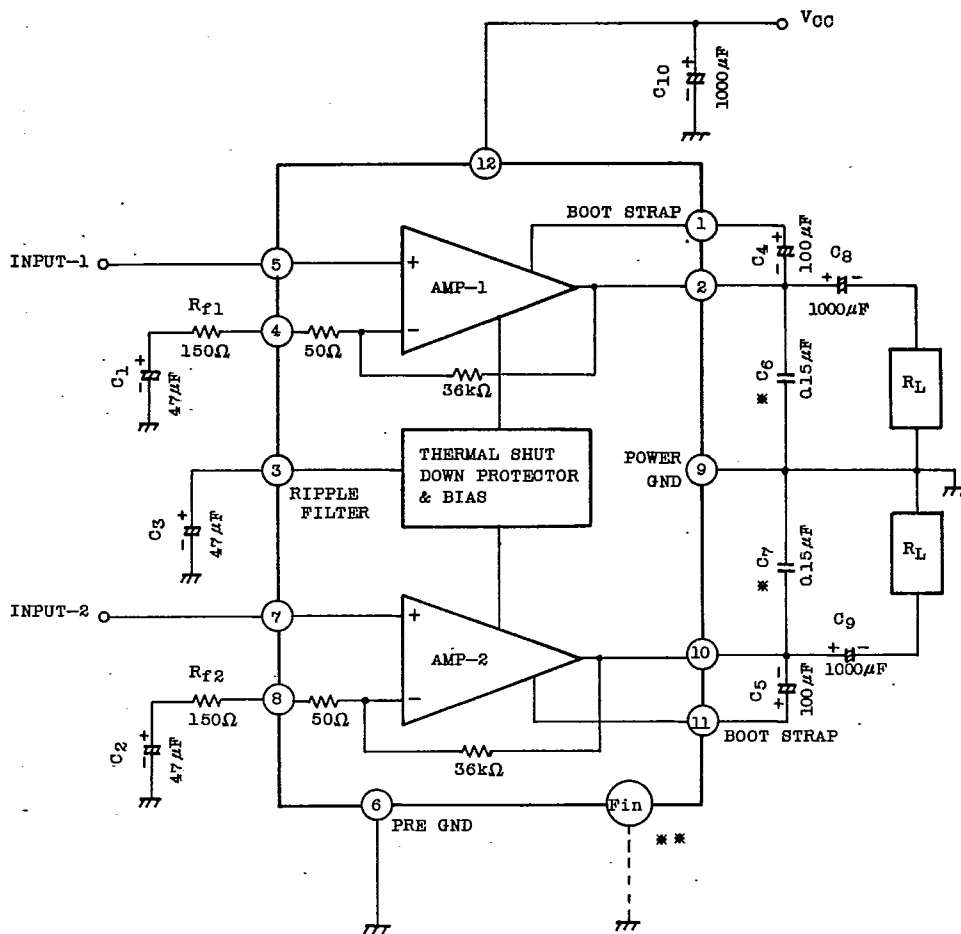

\* C<sub>6</sub>, C<sub>7</sub> : Polystiroll capacitor

\*\* Heat Sink (Fin) : Connect to GND or open

AUDIO LINEAR IC

**TA7233P**

T-74-05-01

## APPLICATION INFORMATION

## 1. VOLTAGE GAIN ADJUSTMENT

The voltage gain :  $G_v$  is determined by  $R_1$ ,  $R_2$  and  $R_f$ .

$$G_v = 20 \log \frac{R_f + R_1 + R_2}{R_f + R_1}$$

When  $R_f = 0$

$$G_v = 57 \text{dB (Typ.)}$$

When  $R_f = 150 \Omega$

$$G_v = 45 \text{dB (Typ.) is given.}$$

The recommended voltage gain is more than 40dB.

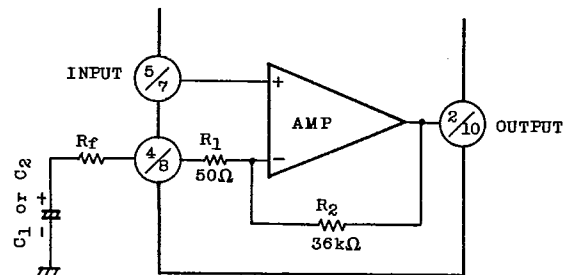

Fig. 1

## 2. AUDIO MUTING

Audio muting can be accomplished by connecting 3 pin (ripple filter) to GND as shown in Fig.2.

Then, the bias circuit are cut off. Amount of muting attenuation is about 60dB.

The ripple filter :  $C_3$  is in dead states at muting on. Therefore, the ripple rejection ratio should be checked at muting on/off in applications.

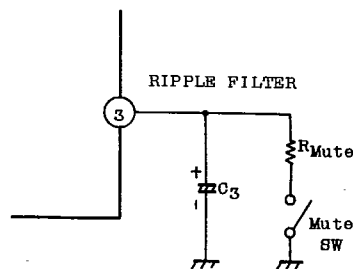

Fig. 2

**TA7233P**

T-74-05-01

**3. INPUT AMPLIFIER**

The first stage is a PNP transistor, the input terminal voltage ( $Q_1$  base) is 60mV and less, and the volume :  $V_R$  can be directly coupled without a coupling capacitor.

But volume slide noise should be checked at volume up/down in applications.

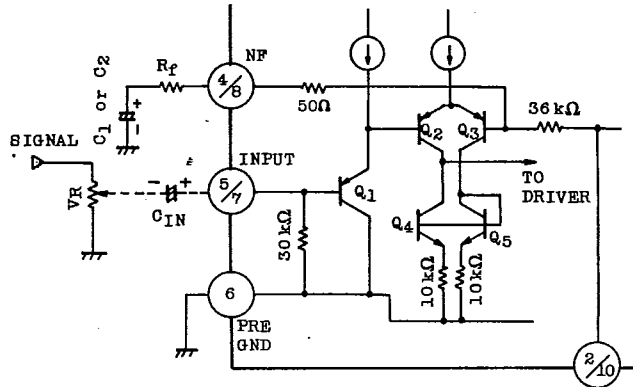

Fig. 3

**4. THERMAL SHUT DOWN CIRCUIT**

This IC built in thermal shut down protector.

The operating temperature of thermal shut down circuit is 160°C (Typ.)

**5. CAPACITOR  $C_6$ ,  $C_7$** 

The purpose of capacitor  $C_6$ ,  $C_7$  are to prevent oscillation.

These capacitors need to be small temperature coefficient.

So celamic capacitor is unsuitable.

The voltage gain less than 40dB results occasionally in a parastic oscillation.

The following capacitor layout is recommended to refer the standard print board.

**6. INPUT VOLTAGE**

The maximum input voltage is 300mV<sub>rms</sub>(typ.). (at  $V_{CC}=12V$ ,  $R_L=4\Omega$ ,  $f=1kHz$ )

When input voltage is more 300mV<sub>rms</sub>, the output wave is turn up.

# TA7233P

## STANDARD PRINT PATTERN

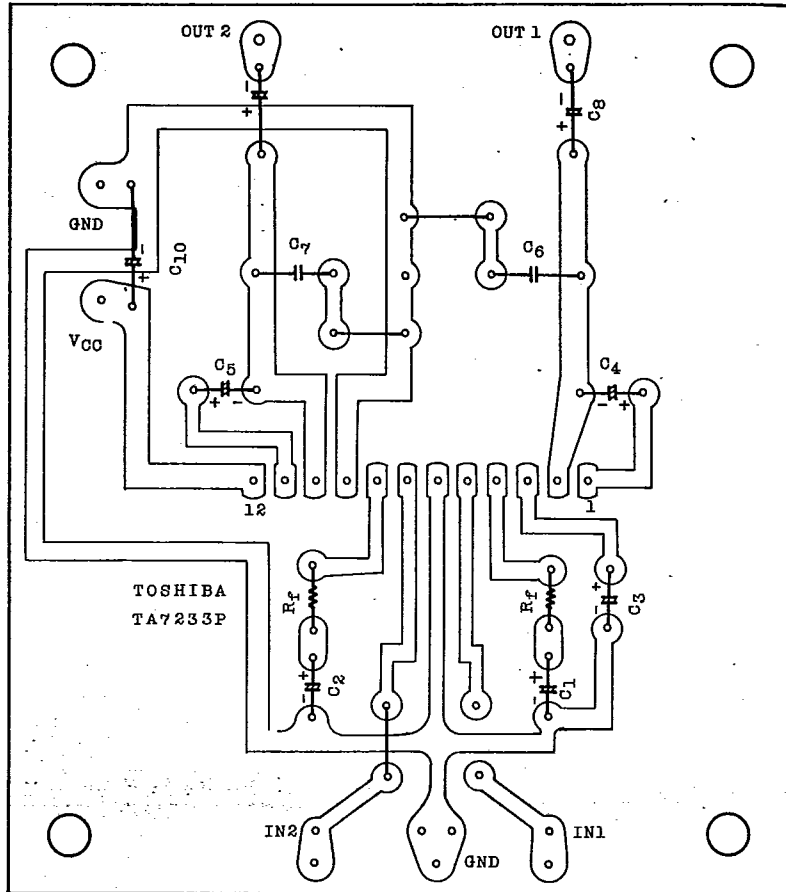

# TA7233P

T-74-05-01

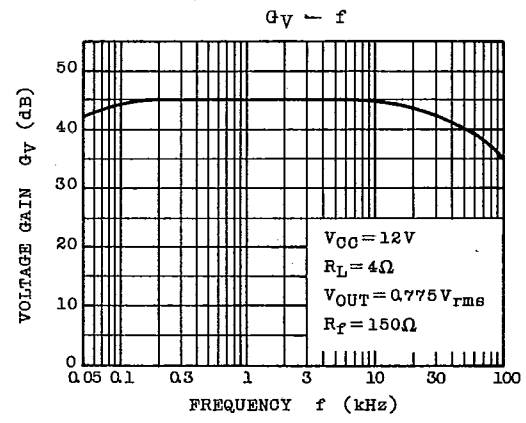
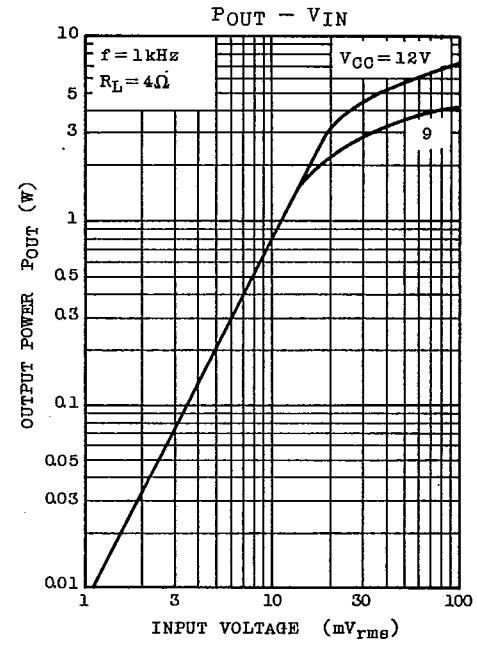
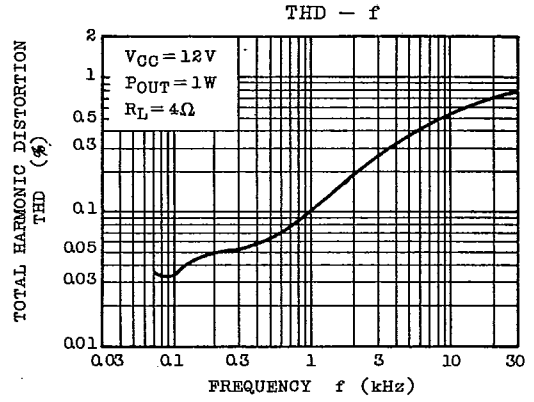
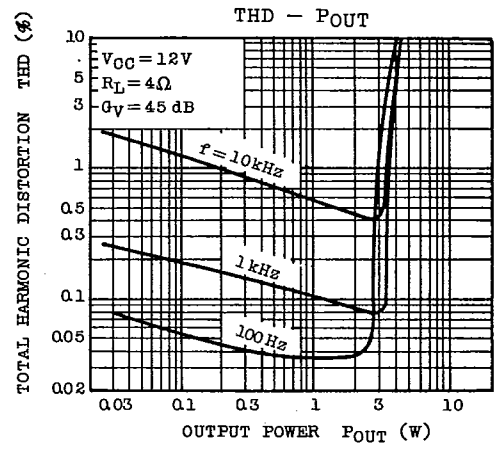
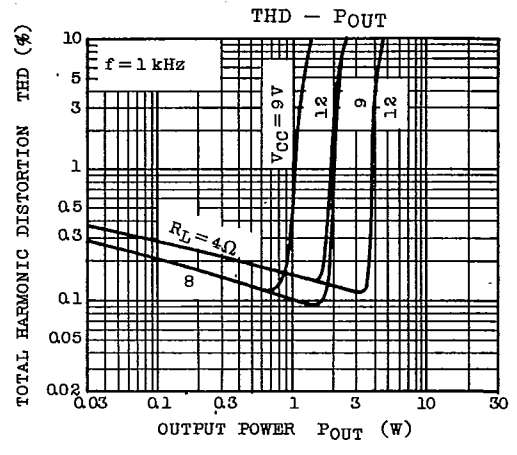

**AUDIO LINEAR IC**

# TA7233P

T-74-05-01

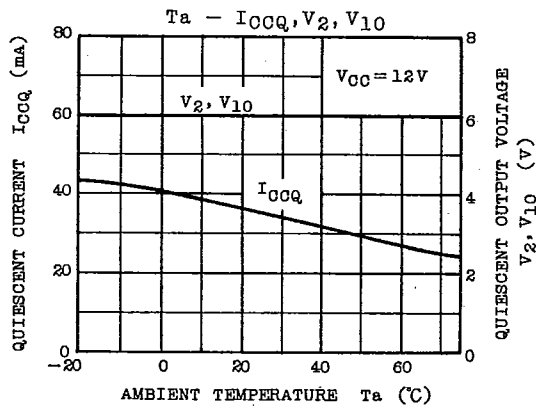
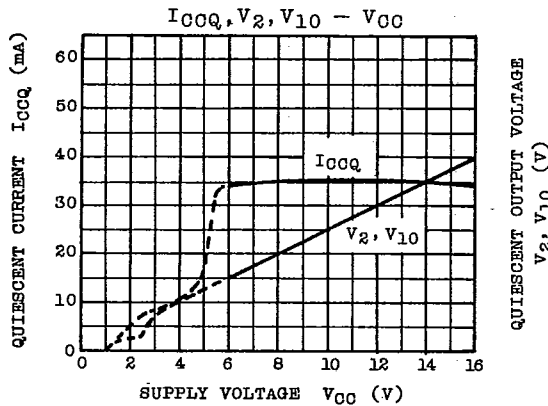
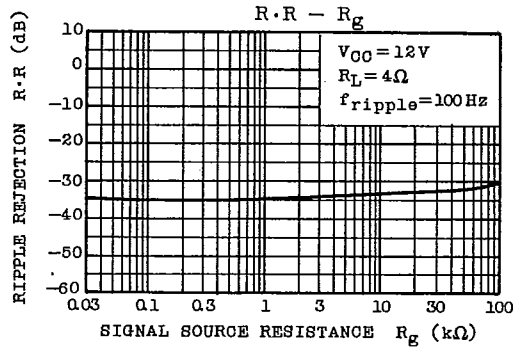
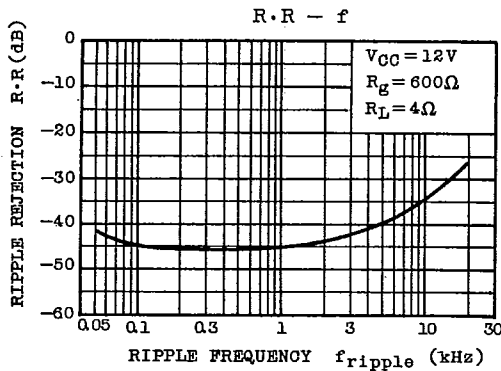
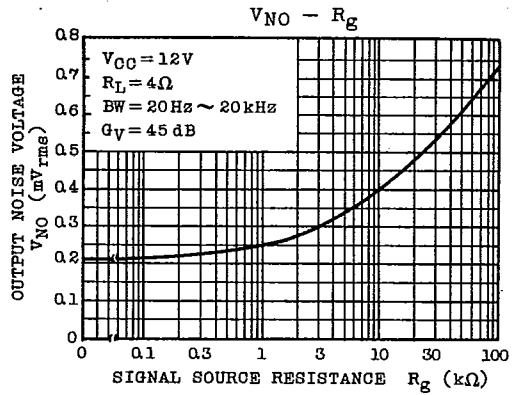
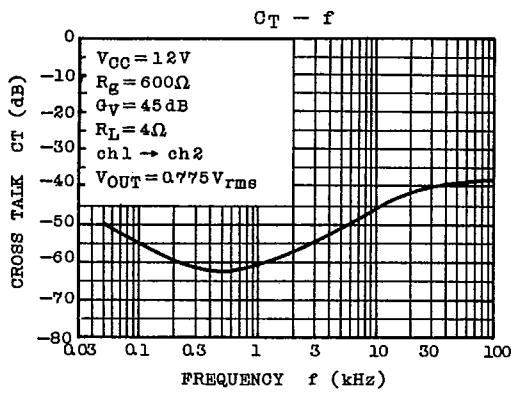



# TA7233P

T-74-05-01

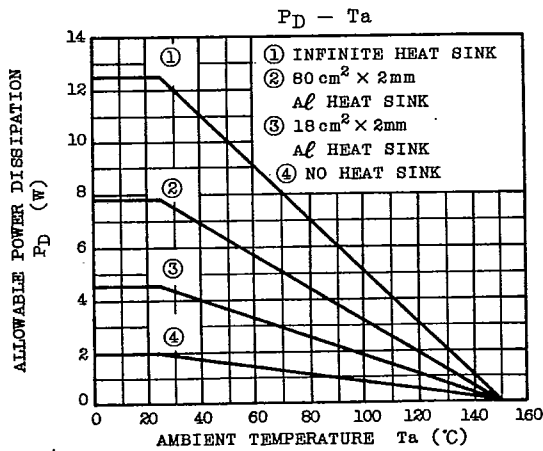
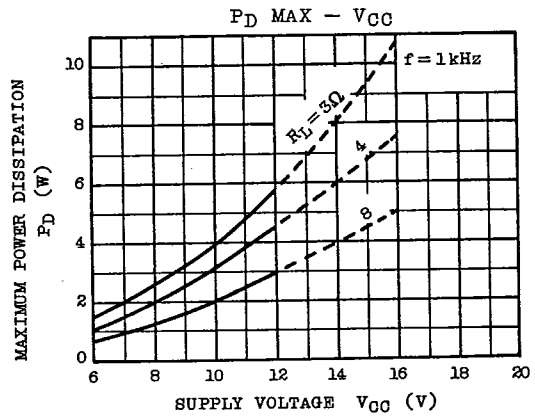
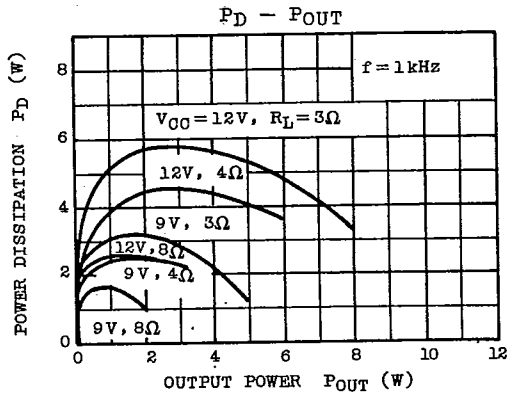
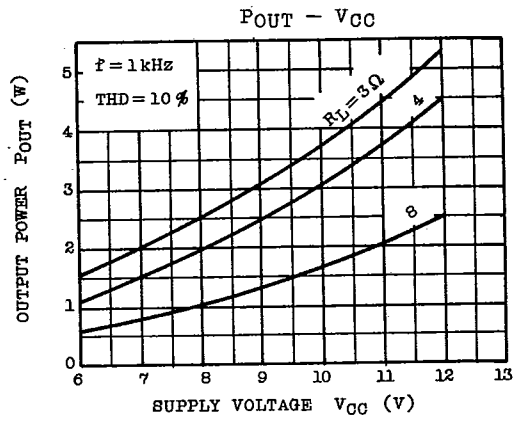
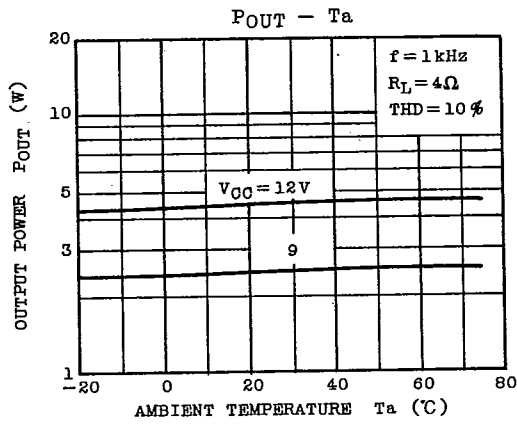

AUDIO LINEAR IC