



## PREAMPLIFIER WITH ALC FOR C<sub>7</sub>O<sub>2</sub> CASSETTE RECORDERS

- EXCELLENT VERSATILITY IN USE ( $V_S$  from 4 to 20V)
- HIGH OPEN LOOP GAIN
- LOW DISTORTION
- LOW NOISE
- LARGE AUTOMATIC LEVEL CONTROL RANGE
- STEREO MATCHING BETTER THAN 3 dB (matched pair)

The TDA 2054M is a monolithic integrated circuit in a 16-lead dual in-line plastic package. The functions incorporated are:

- low noise preamplifier
- automatic level control system (ALC)
- high gain equalization amplifier

It is intended as preamplifier in tape and cassette recorders and players (C<sub>7</sub>O<sub>2</sub>), dictaphones, compressor and expander in telephonic equipments, Hi-Fi preamplifiers and in wire diffusion receivers; for stereo applications the ALC matching is better than 3 dB.

### ABSOLUTE MAXIMUM RATINGS

$V_S$	Supply voltage	20	V
$P_{tot}$	Total power dissipation at $T_{amb} = 50^\circ\text{C}$	500	mW
$T_{stg}, T_J$	Storage and junction temperature	-40 to 150	$^\circ\text{C}$

ORDERING NUMBERS: TDA 2054M mono applications  
2 TDA 2054M stereo applications

### MECHANICAL DATA

Dimensions in mm

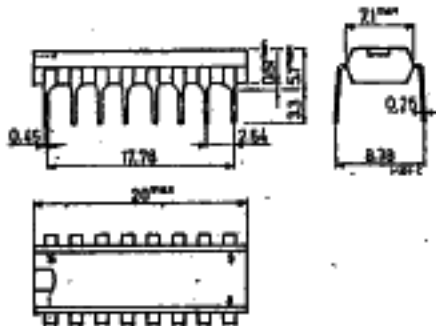

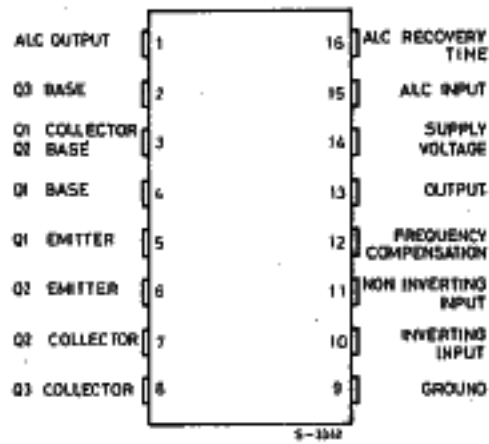
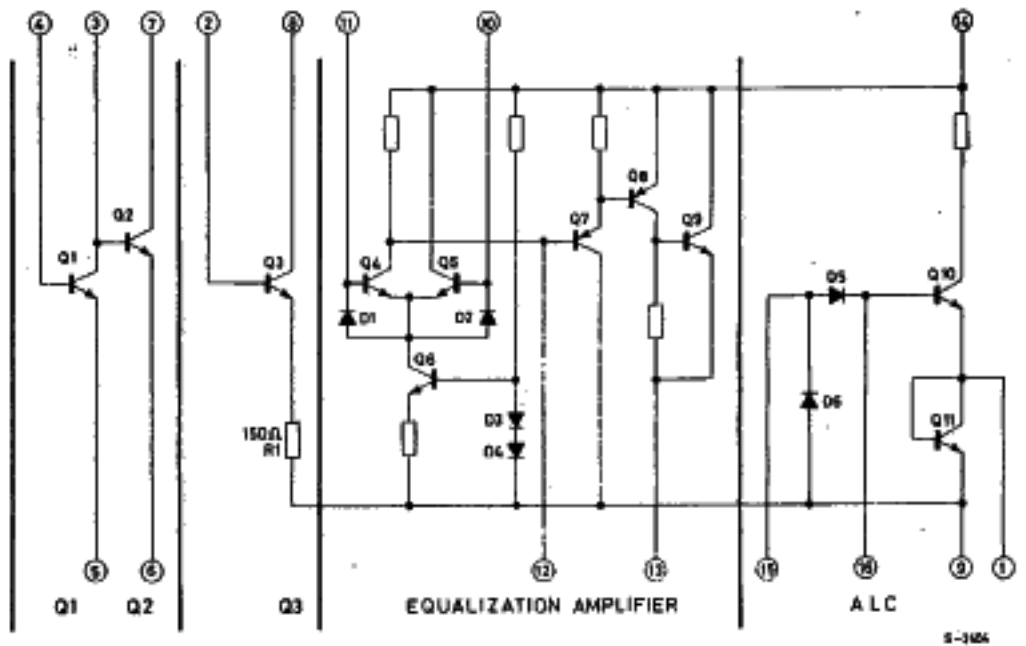
**CONNECTION DIAGRAM**

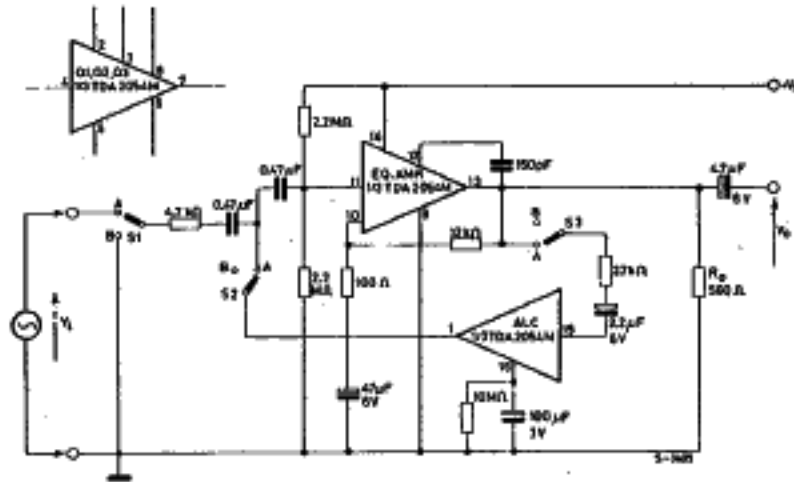
**SCHEMATIC DIAGRAM**

**TEST CIRCUIT**

**THERMAL DATA**

$R_{th\ j-amb}$ Thermal resistance junction-ambient	max 200 °C/W
-----------------------------------------------------	--------------

**ELECTRICAL CHARACTERISTICS (Refer to the test circuit,  $T_{amb} = 25^{\circ}C$ )**

Parameter	Test conditions	Min.	Typ.	Max.	Unit
$V_s$ Supply voltage		4		20	V
$I_d$ Quiescent drain current	$V_s = 9V$ $S1 = S2 = S3 = \text{at B}$		10		mA
$h_{FE}$ DC current gain (Q1, Q2, Q3)	$I_c = 0.1\text{ mA}$ $V_{CE} = 5V$	300	500		-
$e_N$ Input noise voltage (Q1, Q2, Q3)	$I_c = 0.1\text{ mA}$ $V_{CE} = 5V$ $f = 1\text{ KHz}$		2		$\frac{nV}{\sqrt{Hz}}$
$i_N$ Input noise current (Q1, Q2, Q3)			0.5		$\frac{pA}{\sqrt{Hz}}$
NF Noise figure (Q1, Q2, Q3)	$I_c = 0.1\text{ mA}$ $V_{CE} = 5V$ $R_s = 4.7\text{ K}\Omega$ B (-3 dB) = 20 to 10000 Hz		0.5	4	dB
$G_v$ Open loop voltage gain (for equalization amplifier)	$V_s = 9V$ $f = 1\text{ KHz}$		60		dB
$V_o$ Output voltage with A.L.C.	$V_s = 9V$ $V_i = 100\text{ mV}$ $f = 1\text{ KHz}$ $S1 = S2 = S3 \text{ at A}$		0.6		V
$e_{N}$ Equivalent input noise voltage (for equalization amplifier pin 11)	$V_s = 9V$ $G_v = 40\text{ dB}$ $S1 \text{ at B}$ B (-3 dB) = 20 to 20000 Hz		1.3		$\mu V$
$R_1$ Q3 emitter resistance		105	150	195	$\Omega$

Fig. 1 - Equivalent input spot voltage and noise current vs. bias current (transistors Q1, Q2, Q3)

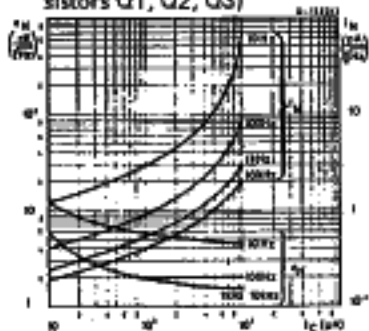

Fig. 2 - Equivalent input noise current vs. frequency (transistors Q1, Q2, Q3)

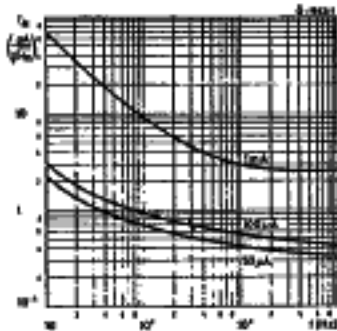

Fig. 3 - Equivalent input noise voltage vs. frequency (transistors Q1, Q2, Q3)

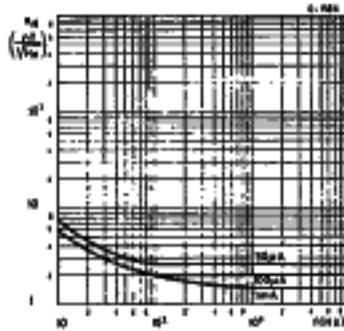

Fig. 4 - Noise figure vs. bias current (transistors Q1, Q2, Q3)

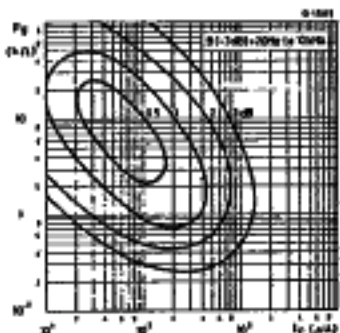

Fig. 5 - Optimum source resistance and minimum NF vs. bias current (transistors Q1, Q2, Q3)

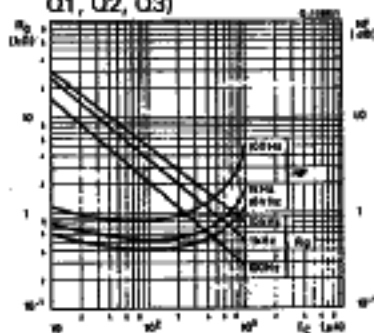

Fig. 6 - Current gain vs. collector current (transistors Q1, Q2, Q3)

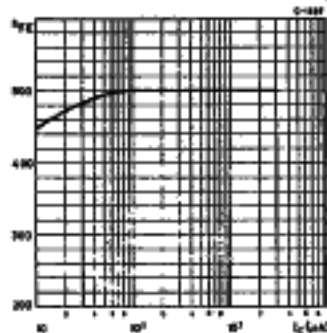

Fig. 7 - Open loop gain vs. frequency (equalization amplifier)

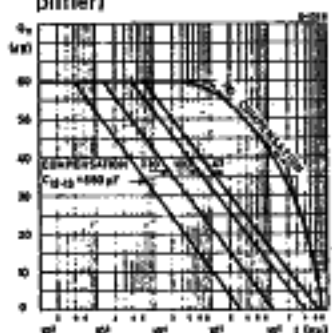

Fig. 8 - Open loop phase response vs. frequency (equalization amplifier)

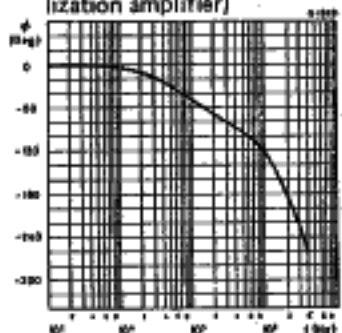
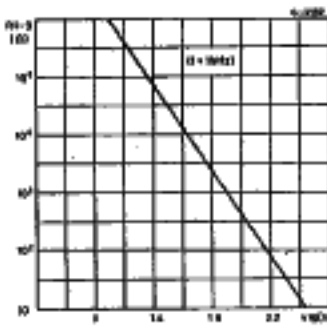

Fig. 9 - Dynamic resistance  $R_{1-9}$  vs. ALC voltage  $V_{16}$



### APPLICATION INFORMATION

Fig. 9 - Application circuit for C<sub>7</sub>O<sub>2</sub> cassette player and recorder

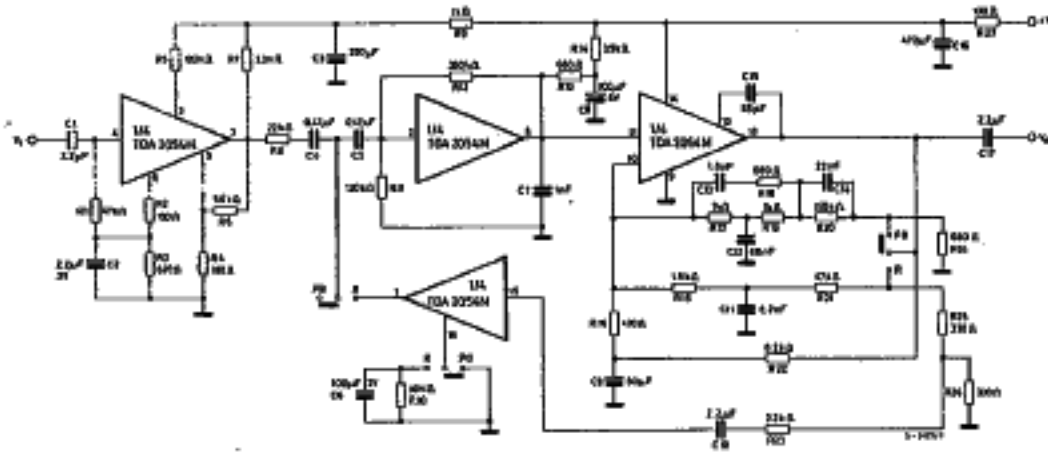
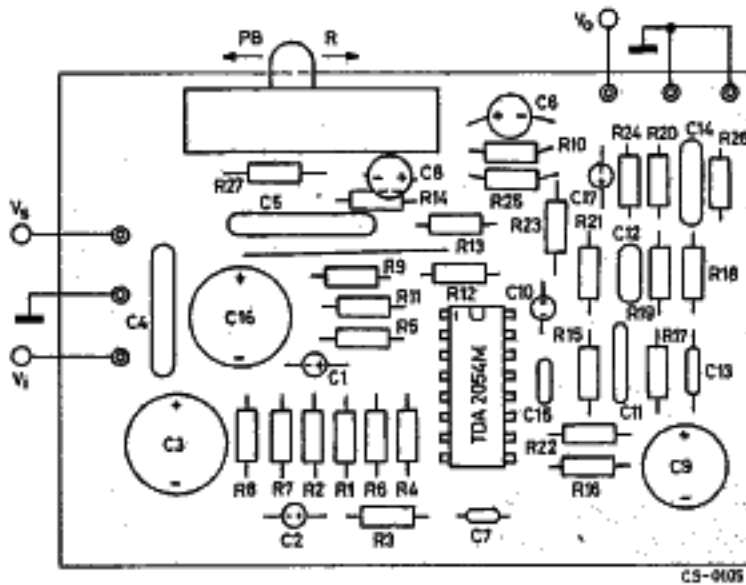

Fig. 10 - P.C. board and component layout for the circuit of Fig. 9 (1:1 scale)



**TYPICAL PERFORMANCE OF CIRCUIT IN FIG. 9 ( $T_{amb} = 25^{\circ}\text{C}$ ,  $V_s = 9\text{V}$ )**

Parameter	Test conditions	Min.	Typ.	Max.	Unit
<b>PLAYBACK</b>					
$G_v$	Voltage gain (open loop)		134		dB
$G_v$	Voltage gain (closed loop)		60		dB
$Z_i$	Input impedance	$f = 100\text{ Hz}$	10		$\text{K}\Omega$
		$f = 1\text{ KHz}$	41		$\text{K}\Omega$
		$f = 10\text{ KHz}$	43		$\text{K}\Omega$
$Z_o$	Output impedance		12	35	$\Omega$
B	Frequency response		see fig. 11		
d	Distortion	$V_o = 1\text{ V}$ $f = 1\text{ KHz}$	0.2		%
	Output background noise	$Z_g = 300\Omega + 120\text{ mH}$ (DIN 45405)	1.5		mV
***	Output weighted background noise		1		mV
S+N N	Signal to noise ratio	$V_o = 1.5\text{ V}$ $Z_g = 300\Omega + 120\text{ mH}$	60		dB
$t_{on}^*$	Switch-on time	$V_o = 1\text{ V}$	500		ms

**RECORDING**

$G_v$	Voltage gain (open loop)	$f = 20\text{ to }20000\text{ Hz}$	134		dB
$G_v$	Voltage gain (closed loop)	$f = 1\text{ KHz}$	72		dB
B	Frequency response		see fig. 13		
d	Distortion with ALC	$V_o = 1\text{ V}$ $f = 10\text{ KHz}$	0.6		%
ALC	Automatic level control range (for 3 dB of output voltage variation)	$V_i < 40\text{ mV}$ $f = 10\text{ KHz}$	54		dB
$V_o$	Output voltage before clipping without ALC	$f = 1\text{ KHz}$	3		V
$V_o$	Output voltage with ALC	$V_i = 30\text{ mV}$ $f = 1\text{ KHz}$	1.1		V
$t_l^*$	Limiting time (see fig. 17)	$\Delta V_i = +40\text{ dB}$ $f = 1\text{ KHz}$	75		ms
$t_{set}^*$	Level setting time (see fig. 17)		300		ms
$t_{rec}^*$	Recovery time (see fig. 17)		150		sec.
$t_{on}^*$	Switch-on-time	$V_o = 1\text{ V}$	500		ms
S+N*** N	Signal to noise ratio with ALC	$V_o = 1\text{ V}$ $R_g = 470\Omega$	64		dB

\* This value depends on external network.

\*\* When the DIN 45511 norm for frequency response is not mandatory the equalization peak at 15 KHz can be avoided - so halving the output noise.

\*\*\* Weighted noise measurement (DIN 45405).

Fig. 11 - Frequency response for the circuit in fig. 9 (playback)

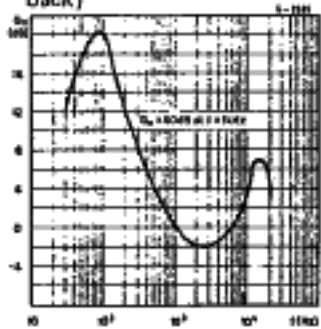

Fig. 12 - Distortion vs. frequency for the circuit in fig. 9 (playback)

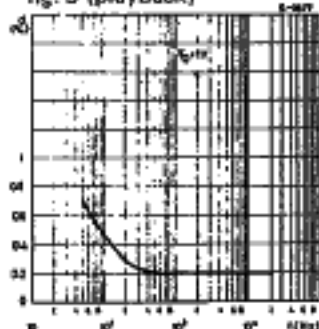

Fig. 13 - Frequency response for the circuit in fig. 9 (recording)

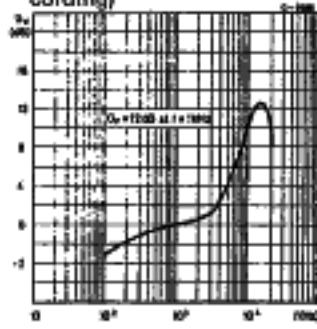

Fig. 14 - Output voltage variation and distortion with ALC vs. input voltage for the circuit in fig. 9 (recording)

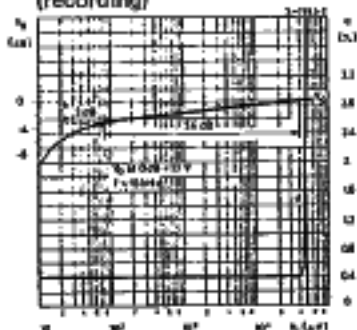

Fig. 15 - Distortion vs. frequency with ALC for the circuit in fig. 9 (recording)

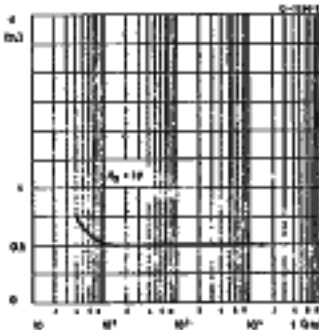

Fig. 16 - Limiting and level setting time vs. input signal variation

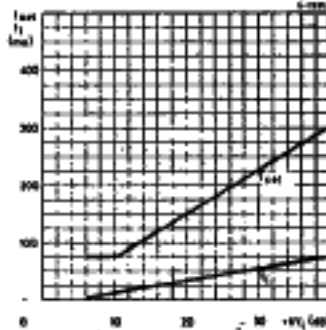

Fig. 17 - Limiting, level setting, recovery time

