

DUAL AUDIO POWER AMPLIFIER

- Output Power : $P_{OUT}=2.4W/CH$ (Typ.)
at $V_{CC}=14V$, $R_L=8\Omega$, THD=10%
- Very Few External Parts (Require 7 pcs capacitor)
- Wide Operating Supply Voltage Range : $V_{CC}=5.5 \sim 20V$
- Built in Turn-on "Pop" Noise Muting Circuit.
- Excellent Cross Talk : C.T=-60dB(Typ.)

MAXIMUM RATINGS ($T_a=25^\circ C$)

CHARACTERISTIC	SYMBOL	RATING	UNIT
Supply Voltage	V_{CC}	24	V
Output Current (Peak)	$I_O(\text{peak})$	1.5	A
Power Dissipation	P_D	12.5	W
Operating Temperature	T_{opr}	-20 ~ 75	$^\circ C$
Storage Temperature	T_{stg}	-55 ~ 150	$^\circ C$

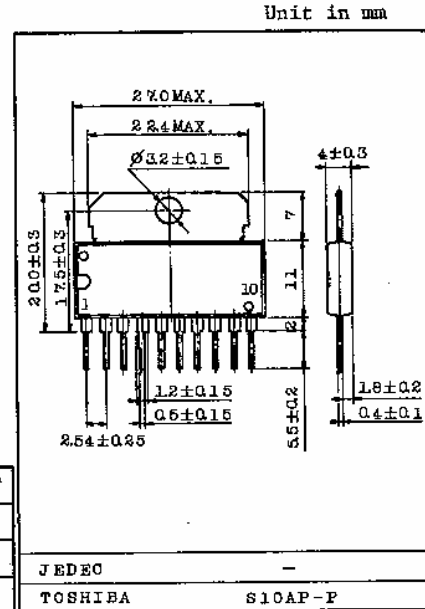

ELECTRICAL CHARACTERISTICS

(Unless otherwise specified, $V_{CC}=14V$, $R_L=8\Omega$, $f=1kHz$, $R_g=600\Omega$, $T_a=25^\circ C$)

CHARACTERISTIC	SYMBOL	TEST CIR-CUIT	TEST CONDITION	MIN.	TYP.	MAX.	UNIT
Quiescent Current	I_{CCQ}	-	$V_{CC}=14V$	-	27	65	mA
			$V_{CC}=20V$	-	3.3	-	
Output Power	P_{OUT}	-	THD=10%	2.0	2.4	-	W
			$R_L=4\Omega$, THD=10%	-	4.0	-	
Voltage Gain	G_V	-	-	46	48	50	dB
Channel Voltage Gain Ratio	ΔG_V	-	-	-	0	1.5	dB
Total Harmonic Distortion	THD	-	$P_O=500mW$	-	0.2	1.2	%
			$R_L=4\Omega$, $P_O=1W$	-	0.4	-	
Output Noise Voltage	V_{NO}	-	$R_g=10k\Omega$	-	0.5	1.5	mV _{rms}
Cross Talk	C.T	-	$R_g=0$, $P_O=1.5W$	-	-60	-45	dB
Input Resistance	R_{IN}	-	$V_{OUT}=1V_{rms}$	-	33	-	k Ω
Ripple Rejection	R.R	-	$R_g=0$, $f=100Hz$	-	-50	-	dB

AUDIO LINEAR IC

BLOCK DIAGRAM

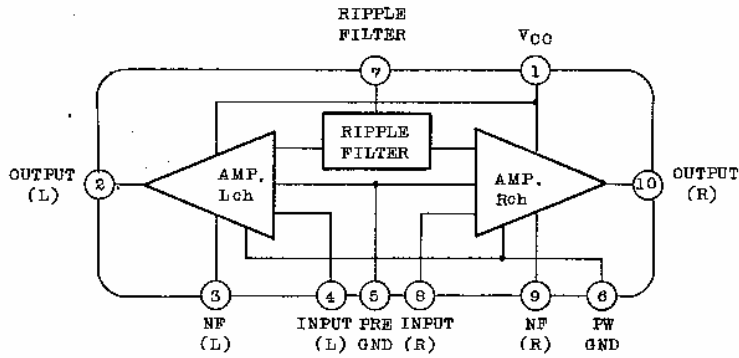

PIN CONNECTION

- ① VCC
- ② L-CH OUTPUT
- ③ L-CH NF
- ④ L-CH INPUT
- ⑤ PRE GND
- ⑥ POWER GND
- ⑦ RIPPLE FILTER
- ⑧ R-CH INPUT
- ⑨ R-CH NF
- ⑩ R-CH OUTPUT

TEST CIRCUIT

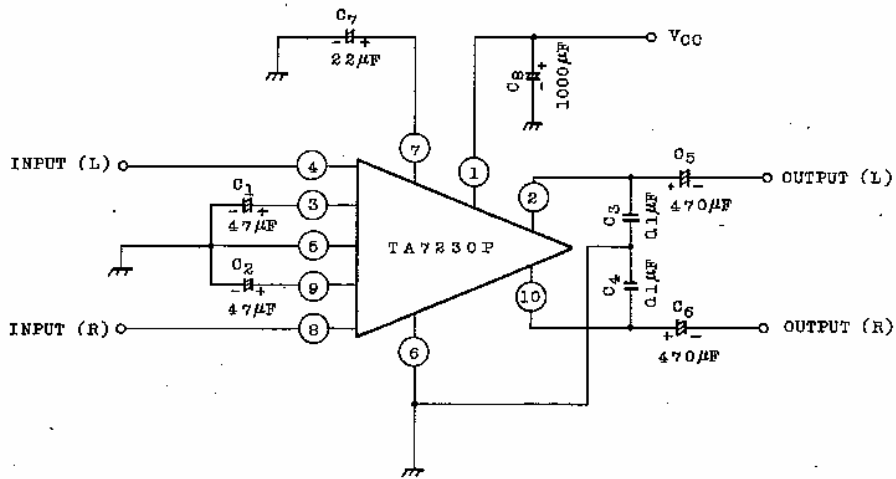

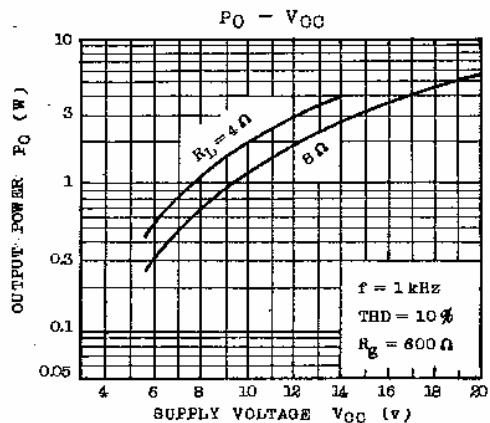
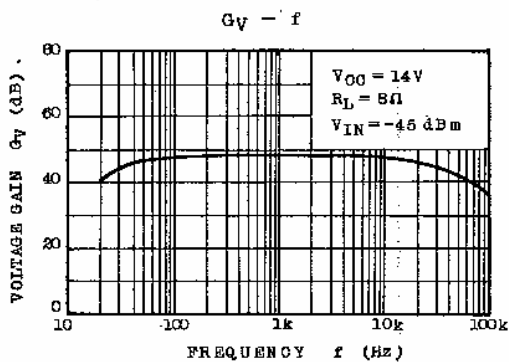
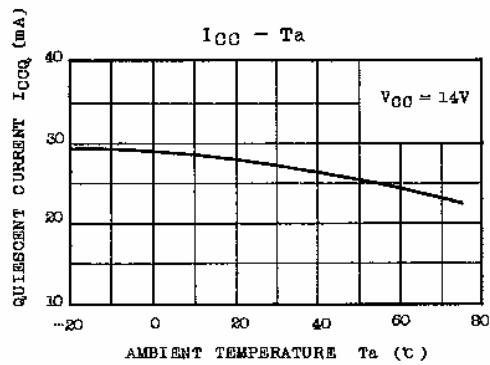
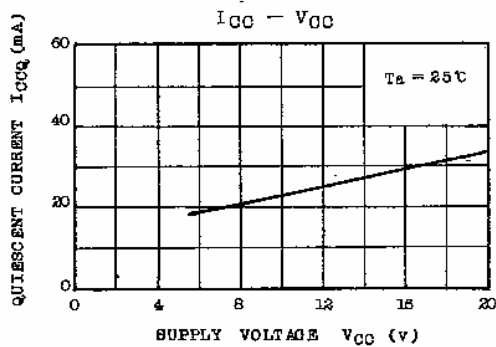
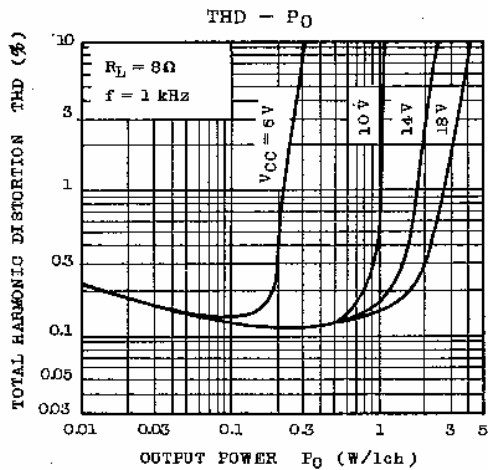
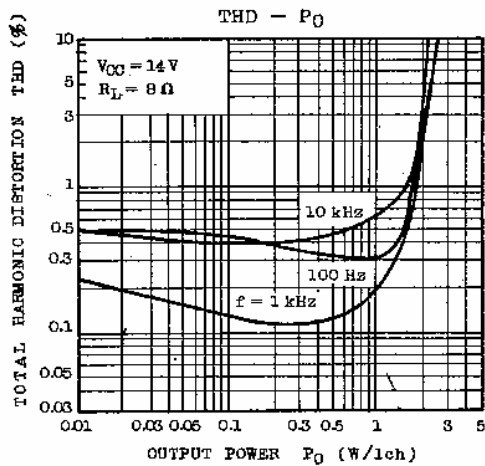

AUDIO LINEAR IC

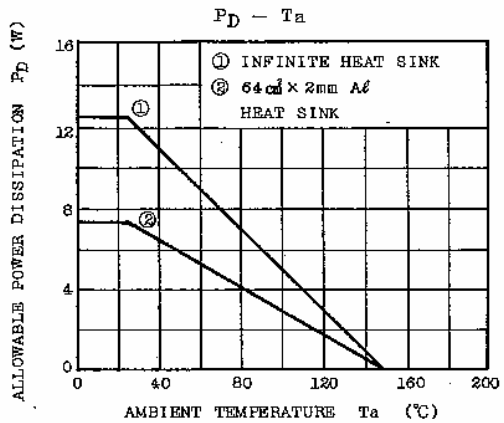
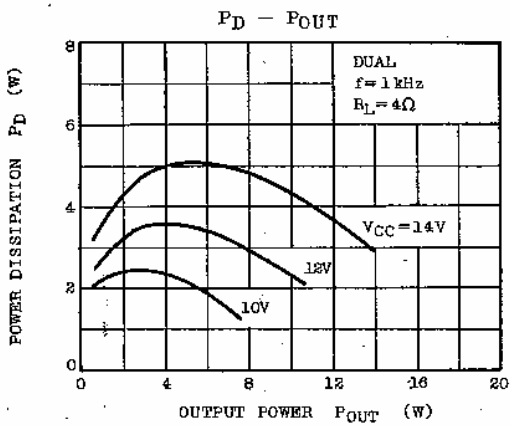
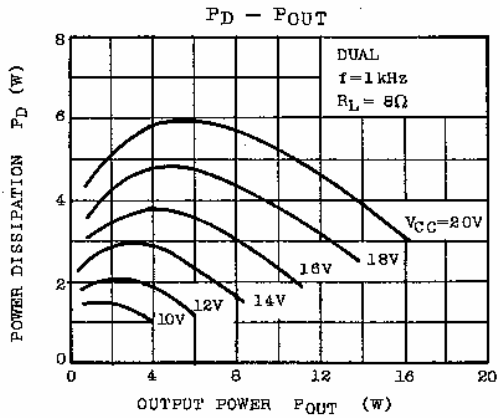
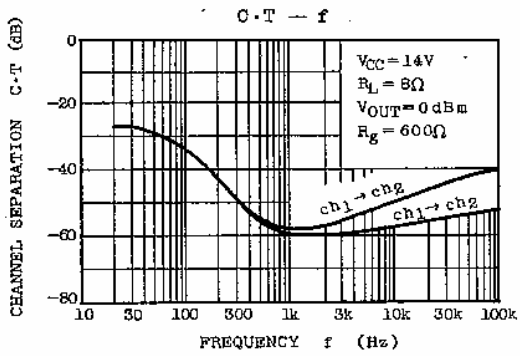
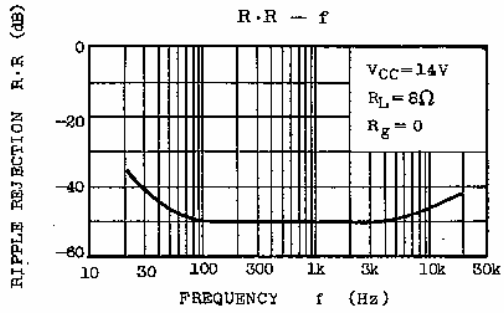
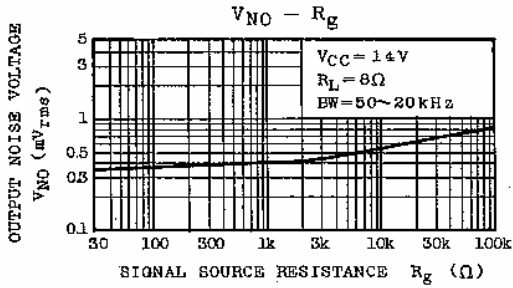

This datasheet has been downloaded from:

www.DatasheetCatalog.com

Datasheets for electronic components.