

Features

- **Low Voltage and Standard Voltage Operation**
 - 5.0 ($V_{CC} = 4.5V$ to $5.5V$)
 - 2.7 ($V_{CC} = 2.7V$ to $5.5V$)
 - 1.8 ($V_{CC} = 1.8V$ to $3.6V$)
- **Internally Organized 16,384 x 8 and 32,768 x 8**
- **2-Wire Serial Interface**
- **Schmitt Trigger, Filtered Inputs for Noise Suppression**
- **Bidirectional Data Transfer Protocol**
- **1 MHz (5V), 400 kHz (2.7V) and 100 kHz (1.8V) Compatibility**
- **Write Protect Pin for Hardware and Software Data Protection**
- **64-Byte Page Write Mode (Partial Page Writes Allowed)**
- **Self-Timed Write Cycle (5 ms typical)**
- **High Reliability**
 - **Endurance: 100,000 Write Cycles**
 - **Data Retention: 40 Years**
 - **ESD Protection: > 4000V**
- **Automotive Grade and Extended Temperature Devices Available**
- **8-Pin JEDEC PDIP, 8-Pin JEDEC and EIAJ SOIC, 14-Pin TSSOP, and 8-Pin Leadless Array Packages**

Description

The AT24C128/256 provides 131,072/262,144 bits of serial electrically erasable and programmable read only memory (EEPROM) organized as 16,384/32,768 words of 8 bits each. The device's cascadable feature allows up to 4 devices to share a common 2-wire bus. The device is optimized for use in many industrial and commercial applications where low power and low voltage operation are essential. The devices are available in space-saving 8-pin JEDEC PDIP, 8-pin EIAJ, 8-pin JEDEC SOIC, 14-pin TSSOP, and 8-pin LAP packages. In addition, the entire family is available in 5.0V (4.5V to 5.5V), 2.7V (2.7V to 5.5V) and 1.8V (1.8V to 3.6V) versions.

Pin Configurations

| Pin Name | Function |
|----------------------------------|--------------------|
| A ₀ to A ₁ | Address Inputs |
| SDA | Serial Data |
| SCL | Serial Clock Input |
| WP | Write Protect |
| NC | No Connect |

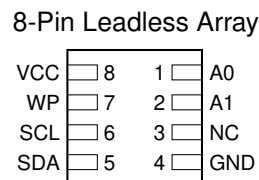
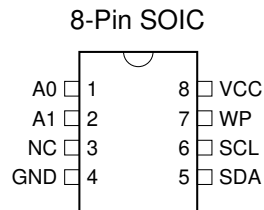
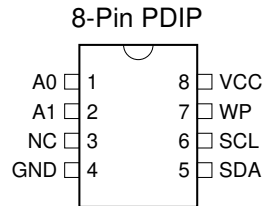
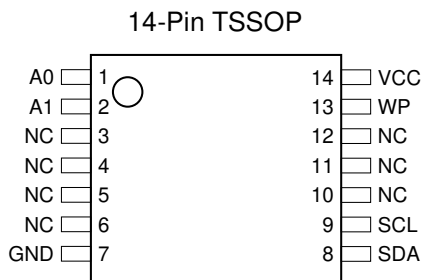

Bottom View



2-Wire Serial EEPROMs

128K (16,384 x 8)

256K (32,768 x 8)

AT24C128

AT24C256



Absolute Maximum Ratings*

| | |
|--|-----------------|
| Operating Temperature | -55°C to +125°C |
| Storage Temperature | -65°C to +150°C |
| Voltage on Any Pin with Respect to Ground | -1.0V to +7.0V |
| Maximum Operating Voltage..... | 6.25V |
| DC Output Current..... | 5.0 mA |

*NOTICE: Stresses beyond those listed under “Absolute Maximum Ratings” may cause permanent damage to the device. This is a stress rating only and functional operation of the device at these or any other conditions beyond those indicated in the operational sections of this specification is not implied. Exposure to absolute maximum rating conditions for extended periods may affect device reliability.

Block Diagram

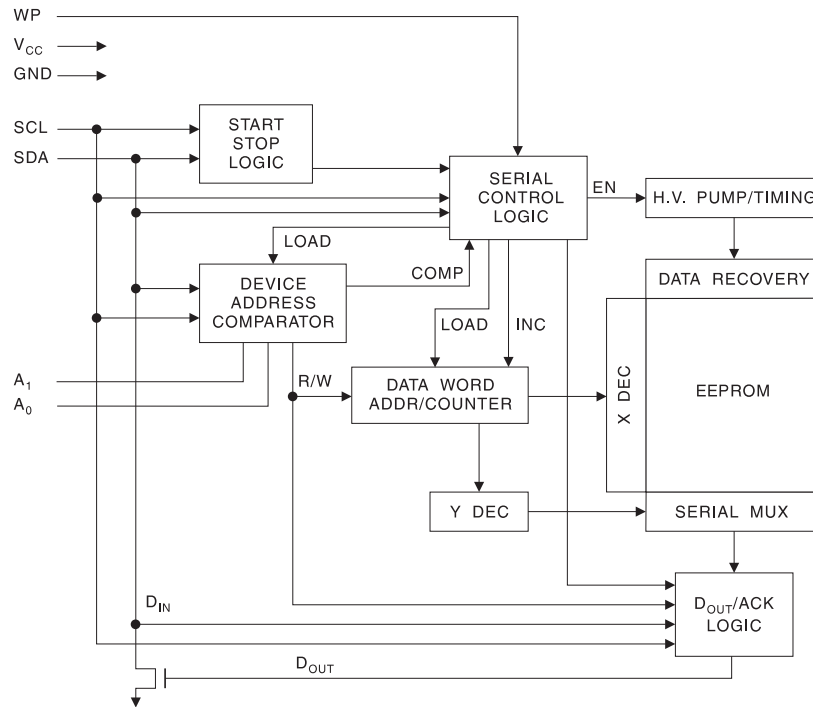

Pin Description

SERIAL CLOCK (SCL): The SCL input is used to positive edge clock data into each EEPROM device and negative edge clock data out of each device.

SERIAL DATA (SDA): The SDA pin is bidirectional for serial data transfer. This pin is open-drain driven and may be wire-ORed with any number of other open-drain or open collector devices.

DEVICE/PAGE ADDRESSES (A1, A0): The A1 and A0 pins are device address inputs that are hardwired or left not connected for hardware compatibility with AT24C32/64. When the pins are hardwired, as many as four 128K/256K devices may be addressed on a single bus system (device addressing is discussed in detail under the Device Addressing section). When the pins are not hardwired, the default A1 and A0 are zero.

WRITE PROTECT (WP): The write protect input, when tied to GND, allows normal write operations. When WP is tied high to V_{CC}, all write operations to the memory are inhibited. If left unconnected, WP is internally pulled down to GND. Switching WP to V_{CC} prior to a write operation creates a software write protect function.

Memory Organization

AT24C128/256, 128K/256K SERIAL EEPROM: The 128K/256K is internally organized as 256/512 pages of 64-bytes each. Random word addressing requires a 14/15-bit data word address.

Pin Capacitance⁽¹⁾

Applicable over recommended operating range from $T_A = 25^\circ\text{C}$, $f = 1.0\text{ MHz}$, $V_{CC} = +1.8\text{V}$.

| Symbol | Test Condition | Max | Units | Conditions |
|-----------|--|-----|-------|-----------------------|
| $C_{I/O}$ | Input/Output Capacitance (SDA) | 8 | pF | $V_{I/O} = 0\text{V}$ |
| C_{IN} | Input Capacitance (A_0, A_1, SCL) | 6 | pF | $V_{IN} = 0\text{V}$ |

Note: This parameter is characterized and is not 100% tested.

DC Characteristics

Applicable over recommended operating range from: $T_{AI} = -40^\circ\text{C}$ to $+85^\circ\text{C}$, $V_{CC} = +1.8\text{V}$ to $+5.5\text{V}$, $T_{AC} = 0^\circ\text{C}$ to $+70^\circ\text{C}$, $V_{CC} = +1.8\text{V}$ to $+5.5\text{V}$ (unless otherwise noted).

| Symbol | Parameter | Test Condition | Min | Typ | Max | Units |
|-----------|-------------------------------------|---|-------------------------------|------|---------------------|---------------|
| V_{CC1} | Supply Voltage | | 1.8 | | 3.6 | V |
| V_{CC2} | Supply Voltage | | 2.7 | | 5.5 | V |
| V_{CC3} | Supply Voltage | | 4.5 | | 5.5 | V |
| I_{CC1} | Supply Current | $V_{CC} = 5.0\text{V}$ READ at 400 kHz | | 1.0 | 2.0 | mA |
| I_{CC2} | Supply Current | $V_{CC} = 5.0\text{V}$ WRITE at 400 kHz | | 2.0 | 3.0 | mA |
| I_{SB1} | Standby Current (1.8V option) | $V_{CC} = 1.8\text{V}$ | $V_{IN} = V_{CC}$ or V_{SS} | | 0.2 | μA |
| | | $V_{CC} = 3.6\text{V}$ | | | 2.0 | |
| I_{SB2} | Standby Current (2.7V option) | $V_{CC} = 2.7\text{V}$ | $V_{IN} = V_{CC}$ or V_{SS} | | 0.5 | μA |
| | | $V_{CC} = 5.5\text{V}$ | | | 6.0 | |
| I_{SB3} | Standby Current (5.0V option) | $V_{CC} = 4.5 - 5.5\text{V}$ $V_{IN} = V_{CC}$ or V_{SS} | | | 6.0 | μA |
| I_{LI} | Input Leakage Current | $V_{IN} = V_{CC}$ or V_{SS} | | 0.10 | 3.0 | μA |
| I_{LO} | Output Leakage Current | $V_{OUT} = V_{CC}$ or V_{SS} | | 0.05 | 3.0 | μA |
| V_{IL} | Input Low Level ^(Note:) | | -0.6 | | $V_{CC} \times 0.3$ | V |
| V_{IH} | Input High Level ^(Note:) | | $V_{CC} \times 0.7$ | | $V_{CC} + 0.5$ | V |
| V_{OL2} | Output Low Level | $V_{CC} = 3.0\text{V}$ $I_{OL} = 2.1\text{ mA}$ | | | 0.4 | V |
| V_{OL1} | Output Low Level | $V_{CC} = 1.8\text{V}$ $I_{OL} = 0.15\text{ mA}$ | | | 0.2 | V |

Note: V_{IL} min and V_{IH} max are reference only and are not tested

AC Characteristics

Applicable over recommended operating range from $T_A = -40^{\circ}\text{C}$ to $+85^{\circ}\text{C}$, $V_{CC} = +1.8\text{V}$ to $+5.5\text{V}$, $CL = 100\text{ pF}$ (unless otherwise noted). Test conditions are listed in Note 2.

| Symbol | Parameter | 1.8-volt | | 2.7-volt | | 5.0-volt | | Units |
|--------------------------|--|----------|-----|----------|-----|----------|------|---------------|
| | | Min | Max | Min | Max | Min | Max | |
| f_{SCL} | Clock Frequency, SCL | | 100 | | 400 | | 1000 | kHz |
| t_{LOW} | Clock Pulse Width Low | 4.7 | | 1.3 | | 0.6 | | μs |
| t_{HIGH} | Clock Pulse Width High | 4.0 | | 1.0 | | 0.4 | | μs |
| t_{AA} | Clock Low to Data Out Valid | 0.1 | 4.5 | 0.05 | 0.9 | 0.05 | 0.55 | μs |
| t_{BUF} | Time the bus must be free before a new transmission can start ⁽¹⁾ | 4.7 | | 1.3 | | 0.5 | | μs |
| $t_{HD.STA}$ | Start Hold Time | 4.0 | | 0.6 | | 0.25 | | μs |
| $t_{SU.STA}$ | Start Set-up Time | 4.7 | | 0.6 | | 0.25 | | μs |
| $t_{HD.DAT}$ | Data In Hold Time | 0 | | 0 | | 0 | | μs |
| $t_{SU.DAT}$ | Data In Set-up Time | 200 | | 100 | | 100 | | ns |
| t_R | Inputs Rise Time ⁽¹⁾ | | 1.0 | | 0.3 | | 0.3 | μs |
| t_F | Inputs Fall Time ⁽¹⁾ | | 300 | | 300 | | 100 | ns |
| $t_{SU.STO}$ | Stop Set-up Time | 4.7 | | 0.6 | | 0.25 | | μs |
| t_{DH} | Data Out Hold Time | 100 | | 50 | | 50 | | ns |
| t_{WR} | Write Cycle Time | | 20 | | 10 | | 10 | ms |
| Endurance ⁽¹⁾ | 5.0V, 25°C, Page Mode | 100K | | 100K | | 100K | | Write Cycles |

Notes: 1. This parameter is characterized and is not 100% tested.

2. AC measurement conditions:

R_L (connects to V_{CC}): 1.3K Ω (2.7V, 5V), 10K Ω (1.8V)

Input pulse voltages: 0.3 V_{CC} to 0.7 V_{CC}

Input rise and fall times: $\leq 50\text{ns}$

Input and output timing reference voltages: 0.5 V_{CC}

Device Operation

CLOCK and DATA TRANSITIONS: The SDA pin is normally pulled high with an external device. Data on the SDA pin may change only during SCL low time periods (refer to Data Validity timing diagram). Data changes during SCL high periods will indicate a start or stop condition as defined below.

START CONDITION: A high-to-low transition of SDA with SCL high is a start condition which must precede any other command (refer to Start and Stop Definition timing diagram).

STOP CONDITION: A low-to-high transition of SDA with SCL high is a stop condition. After a read sequence, the stop command will place the EEPROM in a standby power mode (refer to Start and Stop Definition timing diagram).

ACKNOWLEDGE: All addresses and data words are serially transmitted to and from the EEPROM in 8-bit words. The EEPROM sends a zero during the ninth clock cycle to acknowledge that it has received each word.

STANDBY MODE: The AT24C128/256 features a low power standby mode which is enabled: a) upon power-up and b) after the receipt of the STOP bit and the completion of any internal operations.

MEMORY RESET: After an interruption in protocol, power loss or system reset, any 2-wire part can be reset by following these steps: (a) Clock up to 9 cycles, (b) look for SDA high in each cycle while SCL is high and then (c) create a start condition as SDA is high.

Bus Timing (SCL: Serial Clock, SDA: Serial Data I/O)

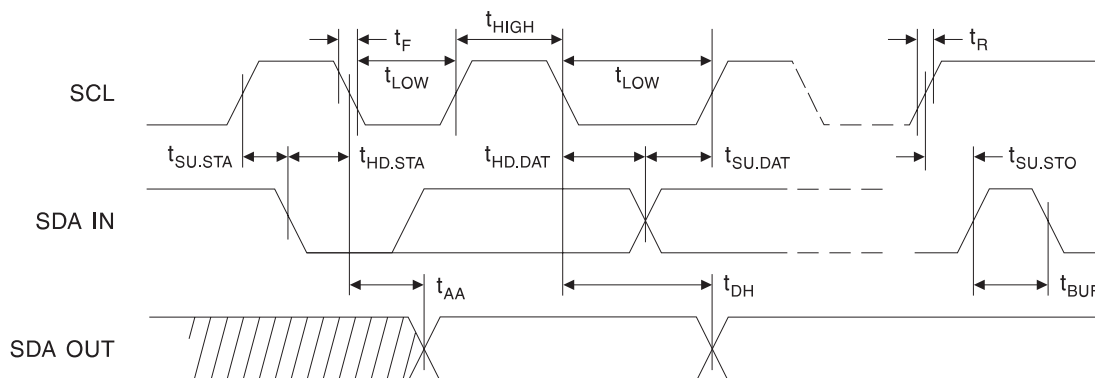

Write Cycle Timing (SCL: Serial Clock, SDA: Serial Data I/O)

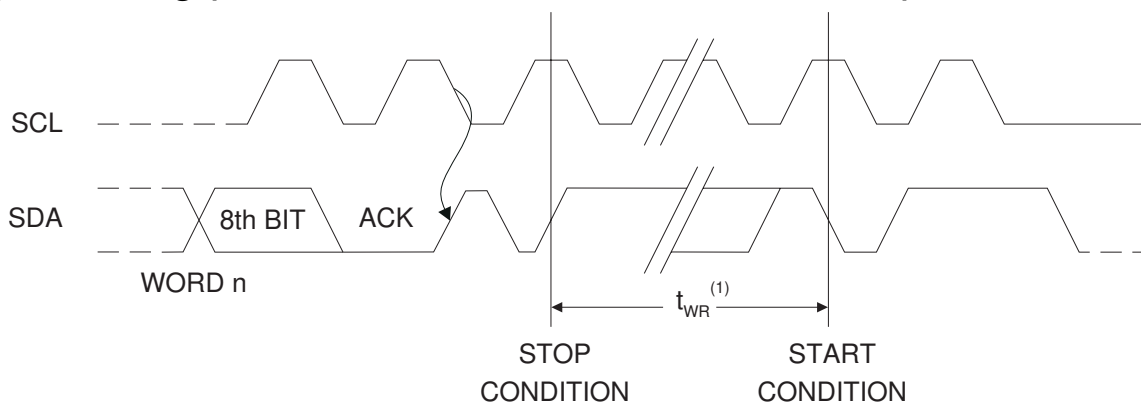

Note: 1. The write cycle time t_{WR} is the time from a valid stop condition of a write sequence to the end of the internal clear/write cycle.

Data Validity

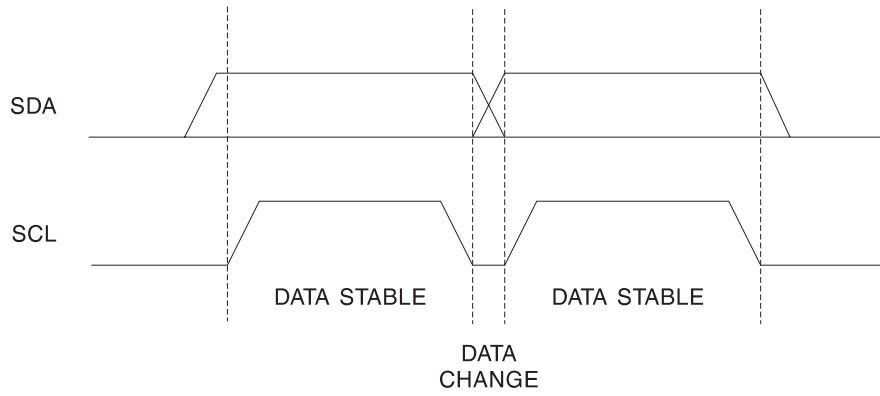

Start and Stop Definition

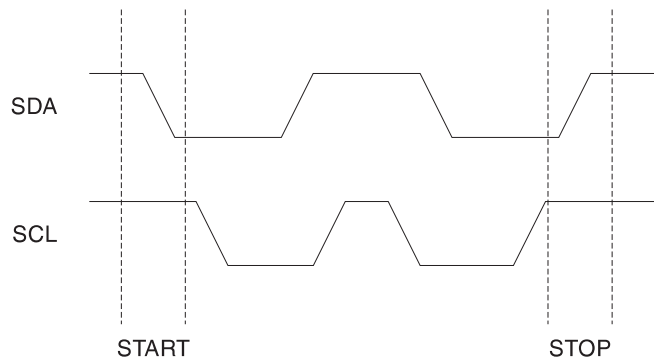

Output Acknowledge

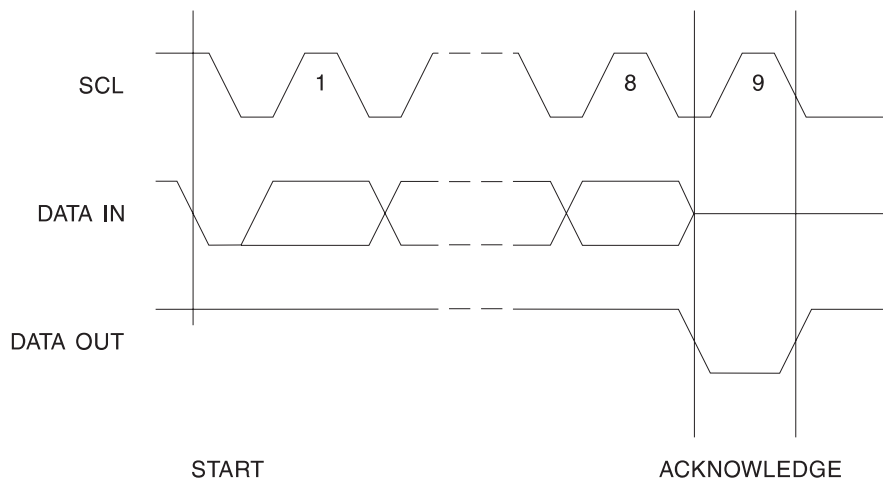

Device Addressing

The 128K/256K EEPROM requires an 8-bit device address word following a start condition to enable the chip for a read or write operation (refer to Figure 1). The device address word consists of a mandatory one, zero sequence for the first five most significant bits as shown. This is common to all 2-wire EEPROM devices.

The 128K/256K uses the two device address bits A1, A0 to allow as many as four devices on the same bus. These bits must compare to their corresponding hardwired input pins. The A1 and A0 pins use an internal proprietary circuit that biases them to a logic low condition if the pins are allowed to float.

The eighth bit of the device address is the read/write operation select bit. A read operation is initiated if this bit is high and a write operation is initiated if this bit is low.

Upon a compare of the device address, the EEPROM will output a zero. If a compare is not made, the device will return to a standby state.

DATA SECURITY: The AT24C128/256 has a hardware data protection scheme that allows the user to write protect the whole memory when the WP pin is at V_{CC} .

Write Operations

BYTE WRITE: A write operation requires two 8-bit data word addresses following the device address word and acknowledgment. Upon receipt of this address, the EEPROM will again respond with a zero and then clock in the first 8-bit data word. Following receipt of the 8-bit data word, the EEPROM will output a zero. The addressing device, such as a microcontroller, then must terminate the write sequence with a stop condition. At this time the EEPROM enters an internally-timed write cycle, t_{WR} , to the nonvolatile memory. All inputs are disabled during this write cycle and the EEPROM will not respond until the write is complete (refer to Figure 2).

PAGE WRITE: The 128K/256K EEPROM is capable of 64-byte page writes.

A page write is initiated the same way as a byte write, but the microcontroller does not send a stop condition after the first data word is clocked in. Instead, after the EEPROM acknowledges receipt of the first data word, the microcontroller can transmit up to 63 more data words. The EEPROM will respond with a zero after each data word received. The microcontroller must terminate the page write sequence with a stop condition (refer to Figure 3).

The data word address lower 6 bits are internally incremented following the receipt of each data word. The higher data word address bits are not incremented, retaining the memory page row location. When the word address, internally generated, reaches the page boundary, the following byte is placed at the beginning of the same page. If more than 64 data words are transmitted to the EEPROM, the

data word address will “roll over” and previous data will be overwritten. The address “roll over” during write is from the last byte of the current page to the first byte of the same page.

ACKNOWLEDGE POLLING: Once the internally-timed write cycle has started and the EEPROM inputs are disabled, acknowledge polling can be initiated. This involves sending a start condition followed by the device address word. The read/write bit is representative of the operation desired. Only if the internal write cycle has completed will the EEPROM respond with a zero, allowing the read or write sequence to continue.

Read Operations

Read operations are initiated the same way as write operations with the exception that the read/write select bit in the device address word is set to one. There are three read operations: current address read, random address read and sequential read.

CURRENT ADDRESS READ: The internal data word address counter maintains the last address accessed during the last read or write operation, incremented by one. This address stays valid between operations as long as the chip power is maintained. The address “roll over” during read is from the last byte of the last memory page, to the first byte of the first page.

Once the device address with the read/write select bit set to one is clocked in and acknowledged by the EEPROM, the current address data word is serially clocked out. The microcontroller does not respond with an input zero but does generate a following stop condition (refer to Figure 4).

RANDOM READ: A random read requires a “dummy” byte write sequence to load in the data word address. Once the device address word and data word address are clocked in and acknowledged by the EEPROM, the microcontroller must generate another start condition. The microcontroller now initiates a current address read by sending a device address with the read/write select bit high. The EEPROM acknowledges the device address and serially clocks out the data word. The microcontroller does not respond with a zero but does generate a following stop condition (refer to Figure 5).

SEQUENTIAL READ: Sequential reads are initiated by either a current address read or a random address read. After the microcontroller receives a data word, it responds with an acknowledge. As long as the EEPROM receives an acknowledge, it will continue to increment the data word address and serially clock out sequential data words. When the memory address limit is reached, the data word address will “roll over” and the sequential read will continue. The sequential read operation is terminated when the microcontroller does not respond with a zero but does generate a following stop condition (refer to Figure 6).

Figure 1. Device Address

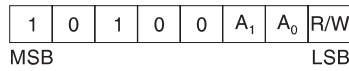

Figure 2. Byte Write

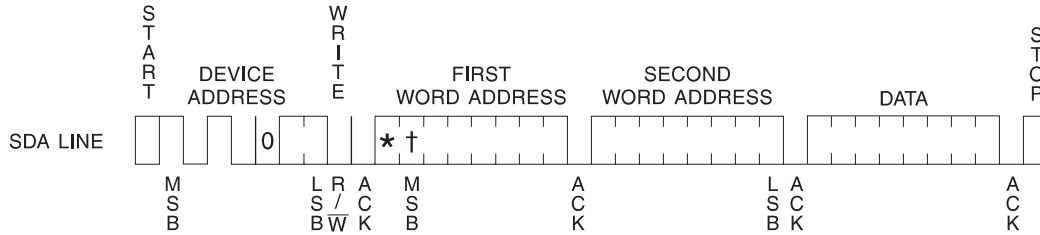
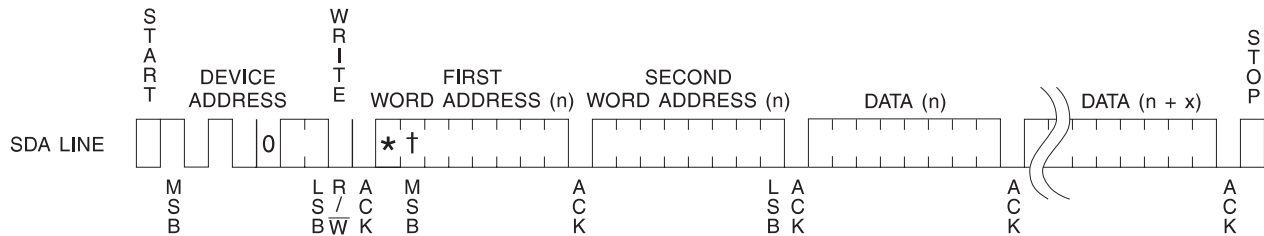

Figure 3. Page Write



(* = DON'T CARE bit)

(† = DON'T CARE bit for the 128K)

Figure 4. Current Address Read

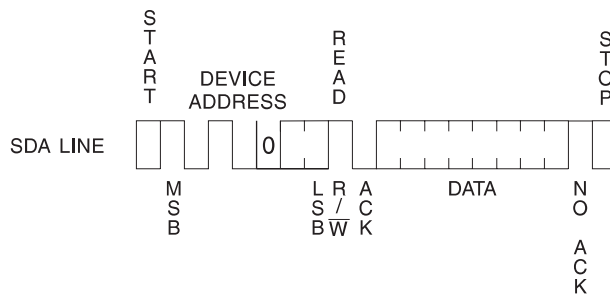
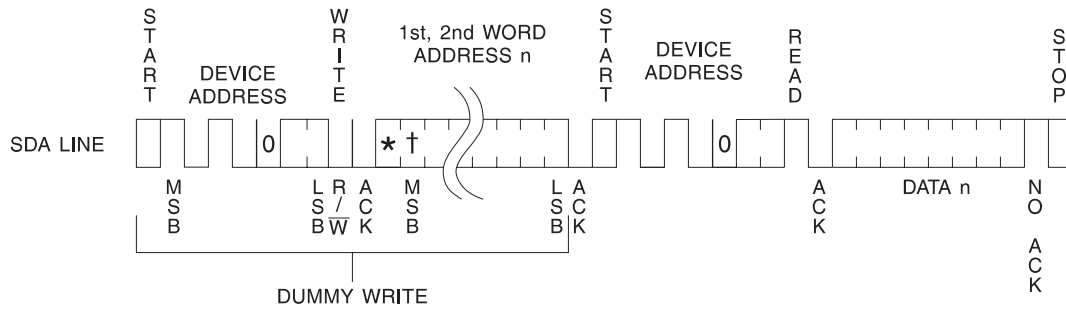

Figure 5. Random Read



(* = DON'T CARE bit)

(† = DON'T CARE bit for the 128K)

Figure 6. Sequential Read

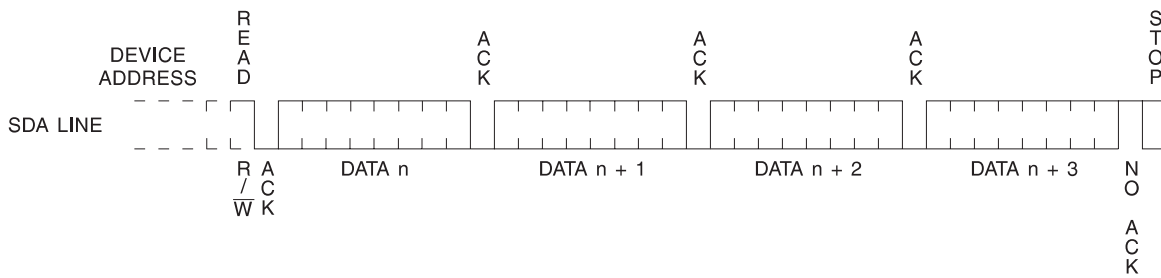



AT24C128 Ordering Information

| t_{WR} (max) (ms) | I_{CC} (max) (μA) | I_{SB} (max) (μA) | f_{MAX} (kHz) | Ordering Code | Package | Operation Range |
|------------------------|-------------------------------|-------------------------------|--------------------|--|---------------------------------------|-------------------------------|
| 10 | 3000 | 6.0 | 1000 | AT24C128-10PC AT24C128N-10SC AT24C128W-10SC AT24C128-10CC AT24C128C1-10CC AT24C128T1-10TC | 8P3 8S1 8S2 8C 8C1 14T | Commercial (0°C to 70°C) |
| | 3000 | 6.0 | 1000 | AT24C128-10PI AT24C128N-10SI AT24C128W-10SI AT24C128-10CI AT24C128C1-10CI AT24C128T1-10TI | 8P3 8S1 8S2 8C 8C1 14T | Industrial (-40°C to 85°C) |
| 10 | 1500 | 0.5 | 400 | AT24C128-10PC-2.7 AT24C128N-10SC-2.7 AT24C128W-10SC-2.7 AT24C128-10CC-2.7 AT24C128C1-10CC-2.7 AT24C128T1-10TC-2.7 | 8P3 8S1 8S2 8C 8C1 14T | Commercial (0°C to 70°C) |
| | 1500 | 0.5 | 400 | AT24C128-10PI-2.7 AT24C128N-10SI-2.7 AT24C128W-10SI-2.7 AT24C128-10CI-2.7 AT24C128C1-10CI-2.7 AT24C128T1-10TI-2.7 | 8P3 8S1 8S2 8C 8C1 14T | Industrial (-40°C to 85°C) |

| Package Type | |
|--------------|---|
| 8C | 8-Lead, 0.230" Wide, Leadless Array Package (LAP) |
| 8C1 | 8-Lead, 0.300" Wide, Leadless Array Package (LAP) |
| 8P3 | 8-Lead, 0.300" Wide, Plastic Dual Inline Package (PDIP) |
| 8S1 | 8-Lead, 0.150" Wide, Plastic Gull Wing Small Outline Package (JEDEC SOIC) |
| 8S2 | 8-Lead, 0.200" Wide, Plastic Gull Wing Small Outline Package (EIAJ SOIC) |
| 14T | 14-Lead, 0.170" Wide, Thin Shrink Small Outline Package (TSSOP) |
| Options | |
| Blank | Standard Operation (4.5V to 5.5V) |
| -2.7 | Low-Voltage (2.7V to 5.5V) |
| -1.8 | Low-Voltage (1.8V to 3.6V) |

AT24C128 Ordering Information (Continued)

| t_{WR} (max) (ms) | I_{CC} (max) (μA) | I_{SB} (max) (μA) | f_{MAX} (kHz) | Ordering Code | Package | Operation Range |
|------------------------|-------------------------------|-------------------------------|--------------------|---------------------|---------|-------------------------------|
| 20 | 800 | 0.2 | 100 | AT24C128-10PC-1.8 | 8P3 | Commercial (0°C to 70°C) |
| | | | | AT24C128N-10SC-1.8 | 8S1 | |
| | | | | AT24C128W-10SC-1.8 | 8S2 | |
| | | | | AT24C128-10CC-1.8 | 8C | |
| | | | | AT24C128C1-10CC-1.8 | 8C1 | |
| | | | | AT24C128T1-10TC-1.8 | 14T | |
| | 800 | 0.2 | 100 | AT24C128-10PI-1.8 | 8P3 | Industrial (-40°C to 85°C) |
| | | | | AT24C128N-10SI-1.8 | 8S1 | |
| | | | | AT24C128W-10SI-1.8 | 8S2 | |
| | | | | AT24C128-10CI-1.8 | 8C | |
| | | | | AT24C128C1-10CI-1.8 | 8C1 | |
| | | | | AT24C128T1-10TI-1.8 | 14T | |

| Package Type | |
|--------------|---|
| 8C | 8-Lead, 0.230" Wide, Leadless Array Package (LAP) |
| 8C1 | 8-Lead, 0.300" Wide, Leadless Array Package (LAP) |
| 8P3 | 8-Lead, 0.300" Wide, Plastic Dual Inline Package (PDIP) |
| 8S1 | 8-Lead, 0.150" Wide, Plastic Gull Wing Small Outline Package (JEDEC SOIC) |
| 8S2 | 8-Lead, 0.200" Wide, Plastic Gull Wing Small Outline Package (EIAJ SOIC) |
| 14T | 14-Lead, 0.170" Wide, Thin Shrink Small Outline Package (TSSOP) |
| Options | |
| Blank | Standard Operation (4.5V to 5.5V) |
| -2.7 | Low-Voltage (2.7V to 5.5V) |
| -1.8 | Low-Voltage (1.8V to 3.6V) |



AT24C256 Ordering Information

| t_{WR} (max) (ms) | I_{CC} (max) (μA) | I_{SB} (max) (μA) | f_{MAX} (kHz) | Ordering Code | Package | Operation Range |
|------------------------|-------------------------------|-------------------------------|--------------------|---------------------|---------|-------------------------------|
| 10 | 3000 | 6.0 | 1000 | AT24C256-10PC | 8P3 | Commercial (0°C to 70°C) |
| | | | | AT24C256N-10SC | 8S1 | |
| | | | | AT24C256W-10SC | 8S2 | |
| | | | | AT24C256-10CC | 8C | |
| | | | | AT24C256C1-10CC | 8C1 | |
| | | | | AT24C256T1-10TC | 14T | |
| | 3000 | 6.0 | 1000 | AT24C256-10PI | 8P3 | Industrial (-40°C to 85°C) |
| | | | | AT24C256N-10SI | 8S1 | |
| | | | | AT24C256W-10SI | 8S2 | |
| | | | | AT24C256-10CI | 8C | |
| | | | | AT24C256C1-10CI | 8C1 | |
| | | | | AT24C256T1-10TI | 14T | |
| 10 | 1500 | 0.5 | 400 | AT24C256-10PC-2.7 | 8P3 | Commercial (0°C to 70°C) |
| | | | | AT24C256N-10SC-2.7 | 8S1 | |
| | | | | AT24C256W-10SC-2.7 | 8S2 | |
| | | | | AT24C256-10CC-2.7 | 8C | |
| | | | | AT24C256C1-10CC-2.7 | 8C1 | |
| | | | | AT24C256T1-10TC-2.7 | 14T | |
| | 1500 | 0.5 | 400 | AT24C256-10PI-2.7 | 8P3 | Industrial (-40°C to 85°C) |
| | | | | AT24C256N-10SI-2.7 | 8S1 | |
| | | | | AT24C256W-10SI-2.7 | 8S2 | |
| | | | | AT24C256-10CI-2.7 | 8C | |
| | | | | AT24C256C1-10CI-2.7 | 8C1 | |
| | | | | AT24C256T1-10TI-2.7 | 14T | |

| Package Type | |
|--------------|---|
| 8C | 8-Lead, 0.230" Wide, Leadless Array Package (LAP) |
| 8C1 | 8-Lead, 0.300" Wide, Leadless Array Package (LAP) |
| 8P3 | 8-Lead, 0.300" Wide, Plastic Dual Inline Package (PDIP) |
| 8S1 | 8-Lead, 0.150" Wide, Plastic Gull Wing Small Outline Package (JEDEC SOIC) |
| 8S2 | 8-Lead, 0.200" Wide, Plastic Gull Wing Small Outline Package (EIAJ SOIC) |
| 14T | 14-Lead, 0.170" Wide, Thin Shrink Small Outline Package (TSSOP) |
| Options | |
| Blank | Standard Operation (4.5V to 5.5V) |
| -2.7 | Low-Voltage (2.7V to 5.5V) |
| -1.8 | Low-Voltage (1.8V to 3.6V) |

AT24C256 Ordering Information (Continued)

| t_{WR} (max) (ms) | I_{CC} (max) (μA) | I_{SB} (max) (μA) | f_{MAX} (kHz) | Ordering Code | Package | Operation Range |
|------------------------|-------------------------------|-------------------------------|--------------------|---------------------|---------|-------------------------------|
| 20 | 800 | 0.2 | 100 | AT24C256-10PC-1.8 | 8P3 | Commercial (0°C to 70°C) |
| | | | | AT24C256N-10SC-1.8 | 8S1 | |
| | | | | AT24C256W-10SC-1.8 | 8S2 | |
| | | | | AT24C256-10CC-1.8 | 8C | |
| | | | | AT24C256C1-10CC-1.8 | 8C1 | |
| | | | | AT24C256T1-10TC-1.8 | 14T | |
| | 800 | 0.2 | 100 | AT24C256-10PI-1.8 | 8P3 | Industrial (-40°C to 85°C) |
| | | | | AT24C256N-10SI-1.8 | 8S1 | |
| | | | | AT24C256W-10SI-1.8 | 8S2 | |
| | | | | AT24C256-10CI-1.8 | 8C | |
| | | | | AT24C256C1-10CI-1.8 | 8C1 | |
| | | | | AT24C256T1-10TI-1.8 | 14T | |

| Package Type | |
|--------------|---|
| 8C | 8-Lead, 0.230" Wide, Leadless Array Package (LAP) |
| 8C1 | 8-Lead, 0.300" Wide, Leadless Array Package (LAP) |
| 8P3 | 8-Lead, 0.300" Wide, Plastic Dual Inline Package (PDIP) |
| 8S1 | 8-Lead, 0.150" Wide, Plastic Gull Wing Small Outline Package (JEDEC SOIC) |
| 8S2 | 8-Lead, 0.200" Wide, Plastic Gull Wing Small Outline Package (EIAJ SOIC) |
| 14T | 14-Lead, 0.170" Wide, Thin Shrink Small Outline Package (TSSOP) |
| Options | |
| Blank | Standard Operation (4.5V to 5.5V) |
| -2.7 | Low-Voltage (2.7V to 5.5V) |
| -1.8 | Low-Voltage (1.8V to 3.6V) |



Packaging Information

8C, 8-Lead, 0.230" Wide, Leadless Array Package (LAP)
Dimensions in Inches and (Millimeters)

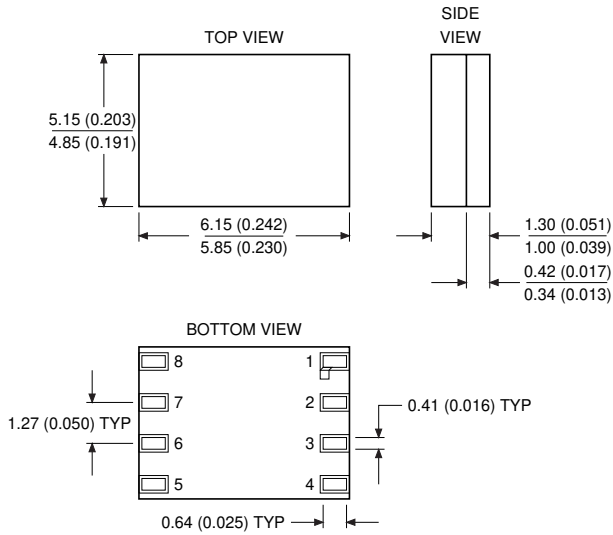

8C1, 8-Lead, 0.300" Wide, Leadless Array Package (LAP)
Dimensions in Inches and (Millimeters)

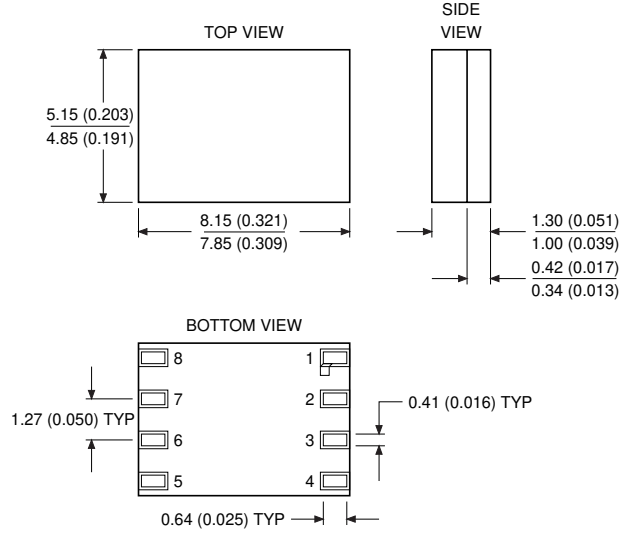

8P3, 8-Lead, 0.300" Wide, Plastic Dual Inline Package (PDIP)
Dimensions in Inches and (Millimeters)
JEDEC STANDARD MS-001 BA

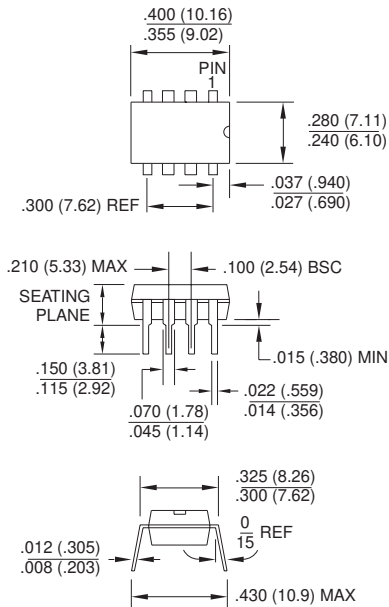

8S1, 8-Lead, 0.150" Wide, Plastic Gull Wing Small Outline (JEDEC SOIC)
Dimensions in Inches and (Millimeters)

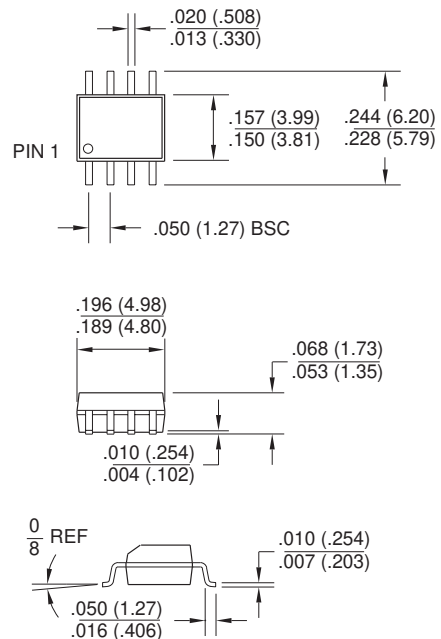

Packaging Information

8S2, 8-Lead, 0.200" Wide,
Plastic Gull Wing Small Outline (EIAJ SOIC)
Dimensions in Inches and (Millimeters)

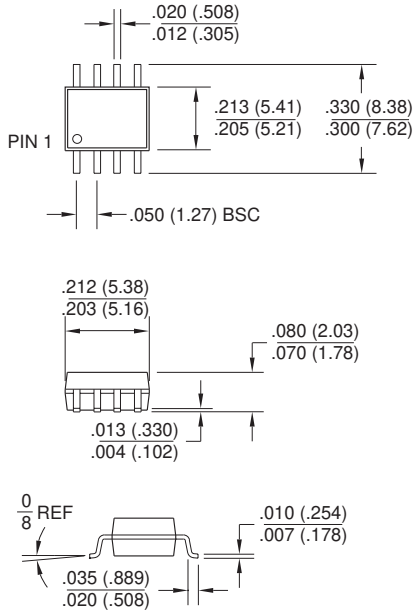

14T, 14-Lead, 0.170" Wide, Thin Shrink Small
Outline Package (TSSOP)
Dimensions in Inches and (Millimeters)

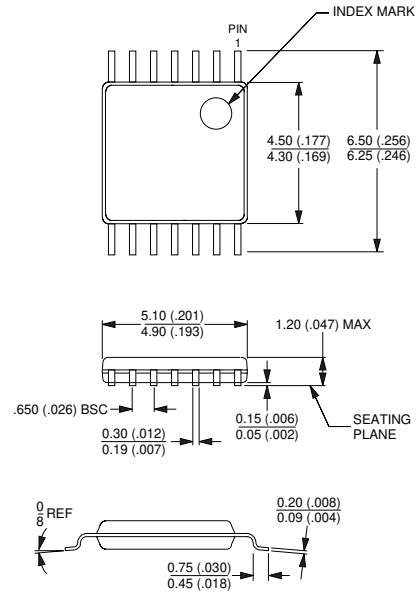

*Controlling dimension: millimeters