

**LA4700N**

2-Channel 12W AF Power Amplifier for Car Stereos

Functions

- Standby switch function built in
- Pop noise suppressor built in
- Thermal shutdown circuit built in
- Overvoltage/surge protector built in
- Output pin-to-GND short protector built in
- Output pin-to-V_{CC} short protector built in
- Load short protector built in

Features

- Low pop noise at the time of power supply ON/OFF
- Excellent oscillation stability

Package Dimensions

unit : mm

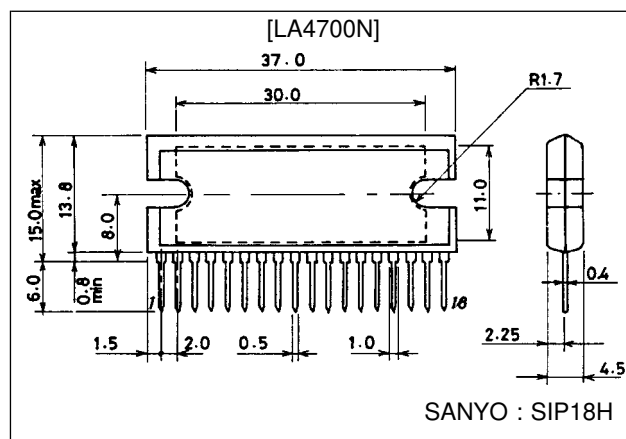
3109-SIP18H

Specifications

Maximum Ratings at Ta = 25°C

Parameter	Symbol	Conditions	Ratings	Unit
Maximum supply voltage	V _{CC} max1	Quiescent t = 30 s	26	V
	V _{CC} max2	Quiescent	18	V
	V _{CC} max3	Operating	16	V
Surge supply voltage	V _{CC} surge	t = 200 ms rise time 1 ms	50	V
Maximum output current	I _o peak	Per channel	4	A
Allowable power dissipation	P _d max	*Note	37.5	W
Operating temperature	T _{opr}		-30 to +75	°C
Storage temperature	T _{stg}		-40 to +150	°C

Operating Conditions at Ta = 25°C

Parameter	Symbol	Conditions	Ratings	Unit
Recommended operating voltage	V _{CC}		13.2	V
Operating voltage range	V _{CC} op		10 to 16	V
Recommended load resistance	R _L	BTL/2ch	4 to 8	Ω

*Note: Use flat head screws for attaching heat sink with tightening torque 39 to 59 N·cm.

LA4700N

**Operating Characteristics at $T_a = 25^\circ\text{C}$, $V_{CC} = 13.2\text{ V}$, $R_L = 4\ \Omega$, $f = 1\text{ kHz}$, $R_g = 600\ \Omega$,
See specified Test Circuit**

Parameter	Symbol	Conditions	min	typ	max	Unit
Quiescent current	I_{CCO}		60	140	200	mA
Voltage gain	VG		48	50	52	dB
Voltage gain difference	ΔVG				2	dB
Total harmonic distortion	THD	$P_o = 1\text{ W}$		0.15	0.75	%
Output voltage	P_o	THD = 10%	10	12		W
Output noise voltage	V_{NO}	$R_g = 0$, B.P.F. = 20 Hz to 20 kHz		0.2	0.4	mV
Ripple rejection	SVRR	$V_r = 0\text{ dBm}$, $f_R = 100\text{ Hz}$, $R_g = 0$	40	55		dB
Channel separation	CHsep	$P_o = 1\text{ W}$, $R_g = 10\text{ k}\Omega$	50	60		dB
Standby current	1st			10	100	μA
Offset voltage	V_{off}		-300		300	mV

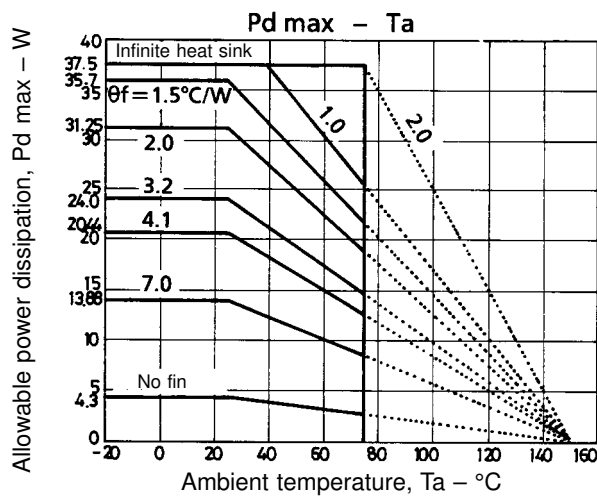

Equivalent Circuit Block Diagram

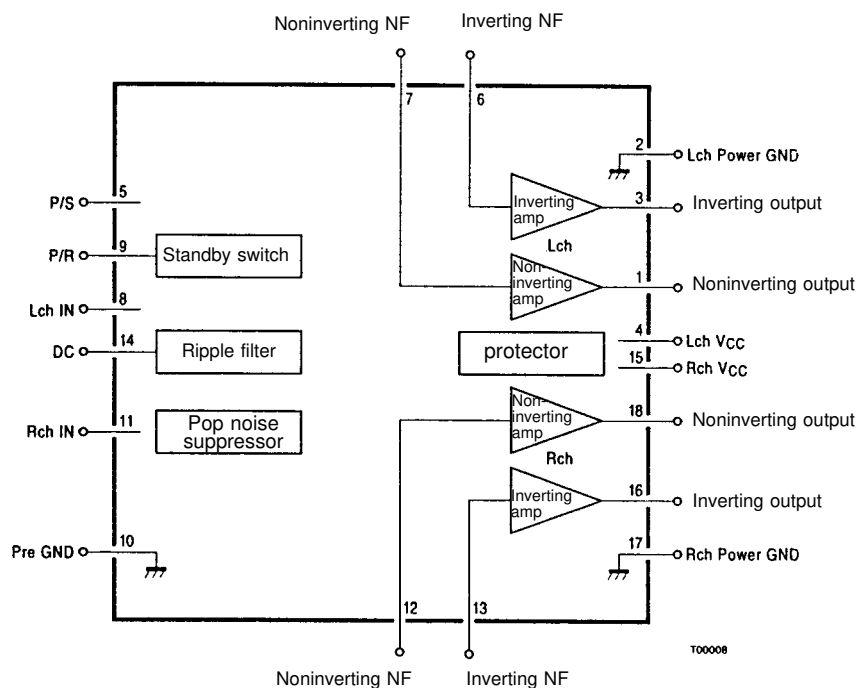

LA4700N

Sample Application Circuit

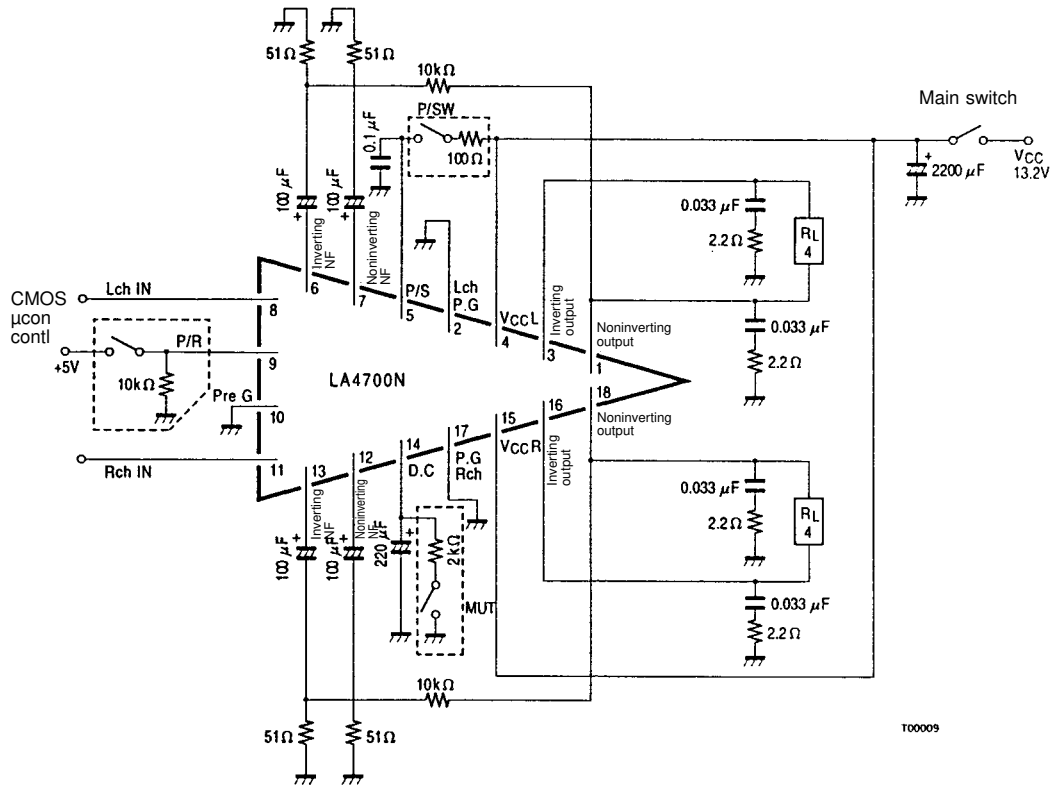

* Connect the portion bounded by a dotted line according to your intended applications. When the power relay is not used, connect pin ⑨ to GND. In this case, the power switch is used to turn ON/OFF the LA4700N or the main switch is used to turn ON/OFF the LA4700N.

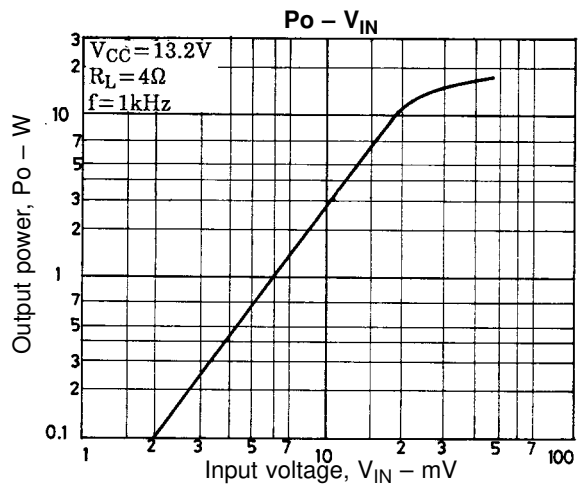
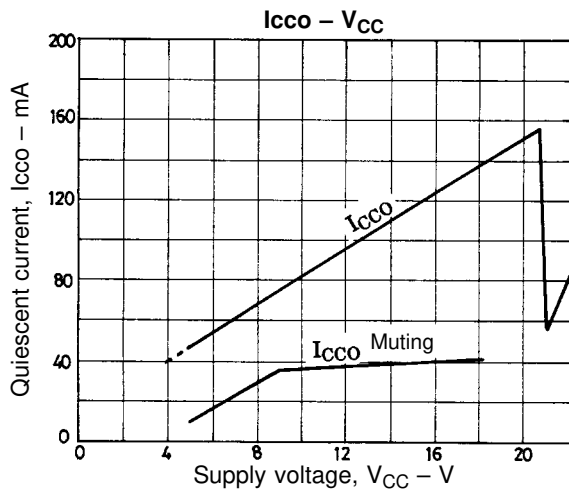

LA4700N

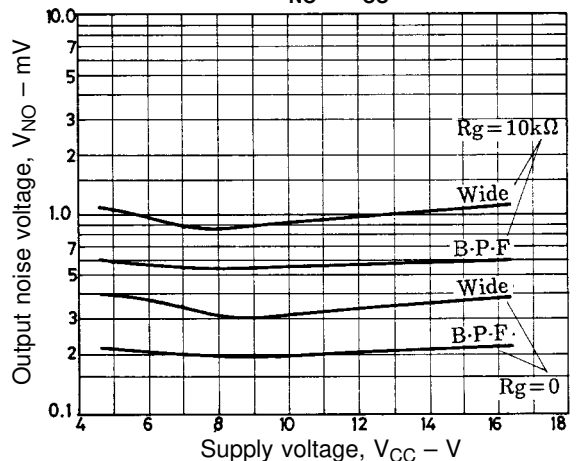
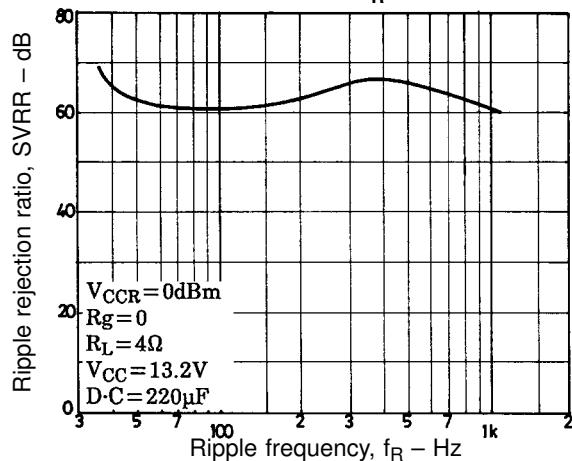
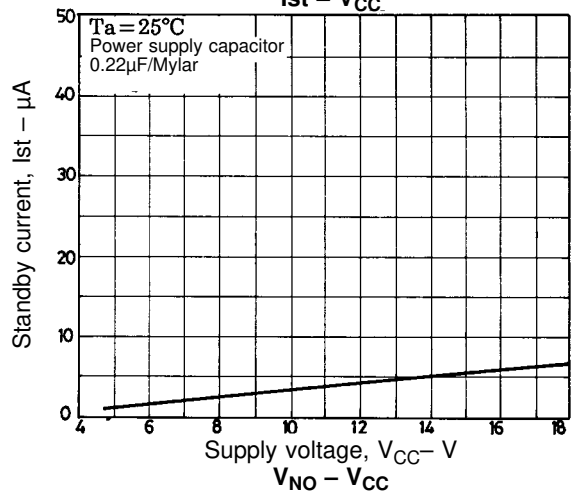
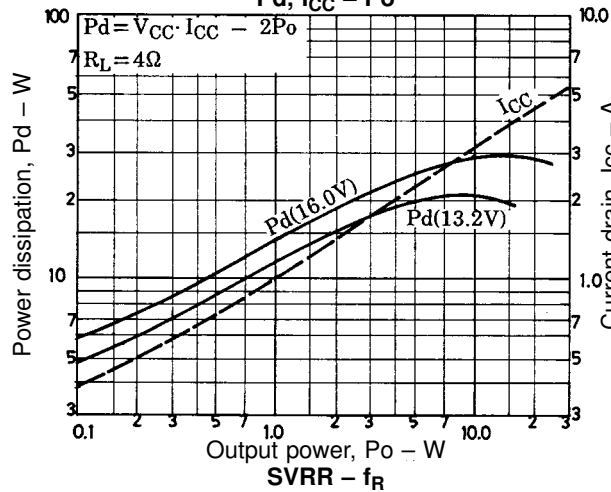
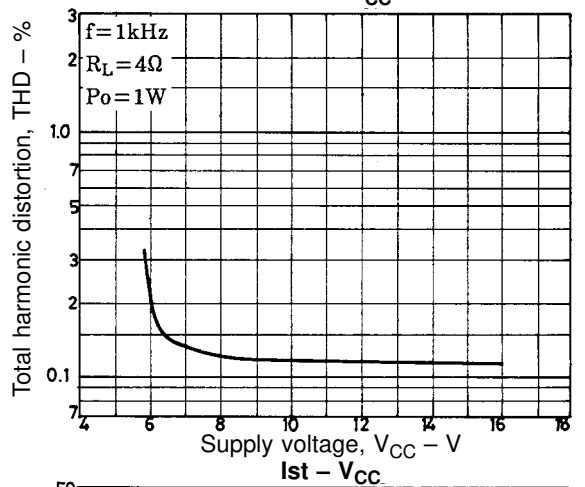
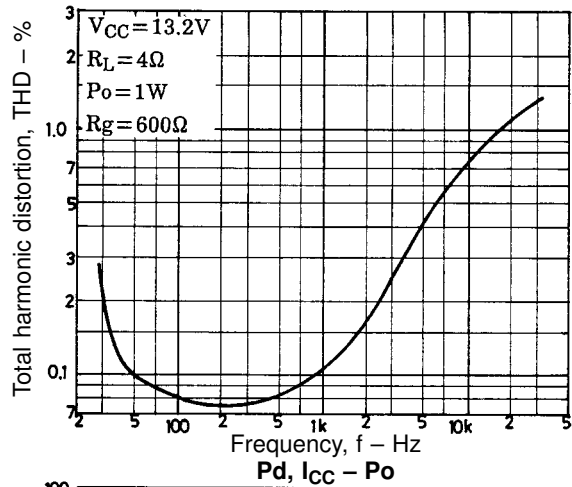
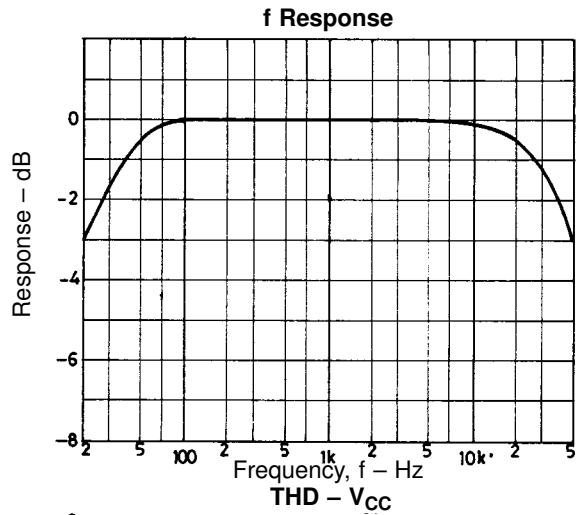
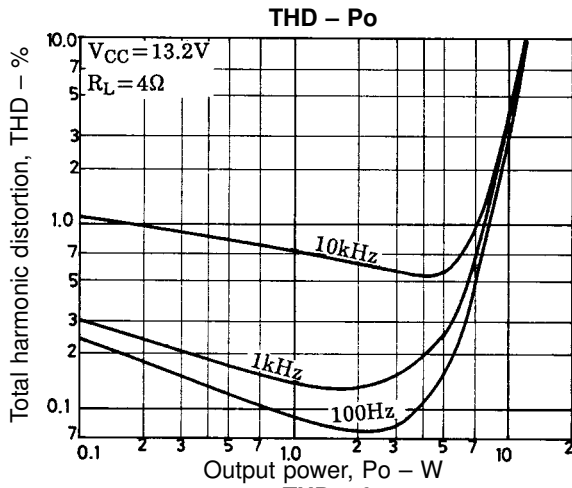

LA4700N

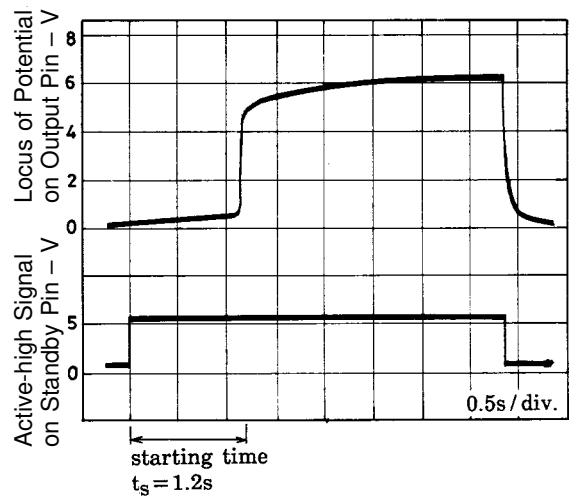
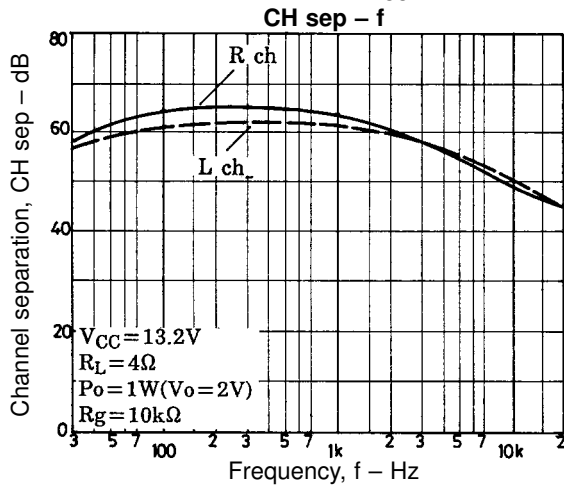
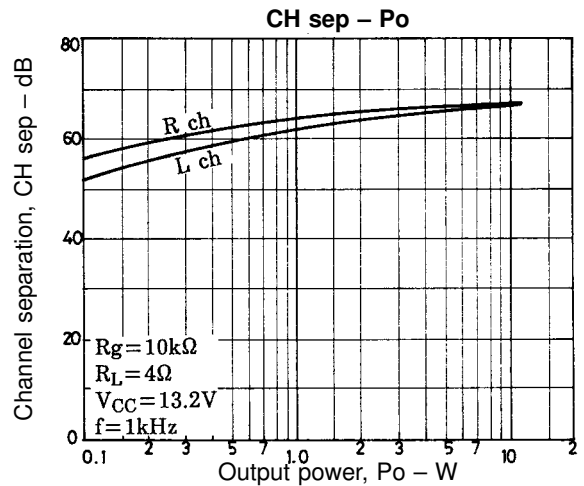
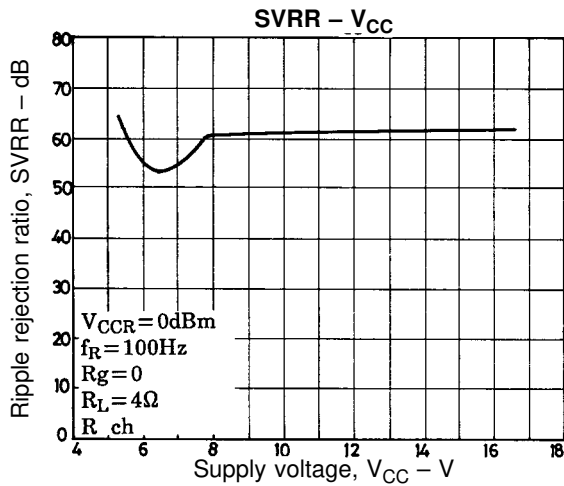

To shorten t_s in the application herein, the filter capacitor (pin 14) value 220 μF is decreased. Filter capacitor value 100 μF gives t_s of 0.6 to 0.7 second.

- No products described or contained herein are intended for use in surgical implants, life-support systems, aerospace equipment, nuclear power control systems, vehicles, disaster/crime-prevention equipment and the like, the failure of which may directly or indirectly cause injury, death or property loss.
- Anyone purchasing any products described or contained herein for an above-mentioned use shall:
 - ① Accept full responsibility and indemnify and defend SANYO ELECTRIC CO., LTD., its affiliates, subsidiaries and distributors and all their officers and employees, jointly and severally, against any and all claims and litigation and all damages, cost and expenses associated with such use:
 - ② Not impose any responsibility for any fault or negligence which may be cited in any such claim or litigation on SANYO ELECTRIC CO., LTD., its affiliates, subsidiaries and distributors or any of their officers and employees jointly or severally.
- Information (including circuit diagrams and circuit parameters) herein is for example only; it is not guaranteed for volume production. SANYO believes information herein is accurate and reliable, but no guarantees are made or implied regarding its use or any infringements of intellectual property rights or other rights of third parties.

This catalog provides information as of April, 1996. Specifications and information herein are subject to change without notice.

This datasheet has been download from:

www.datasheetcatalog.com

Datasheets for electronics components.