

BLA-145

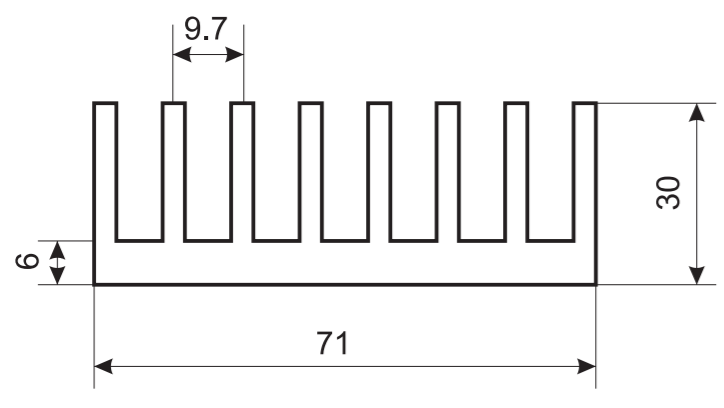

BLA-146

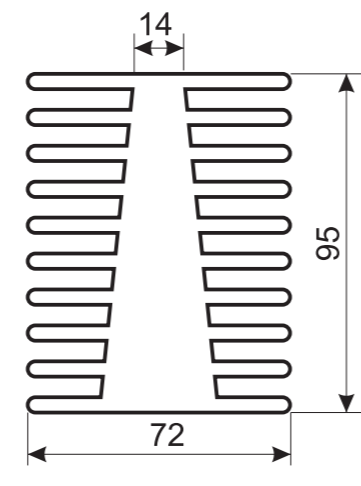

BLA-147

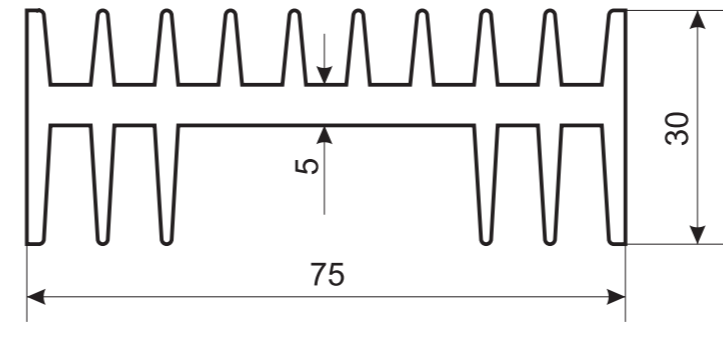

BLA-148

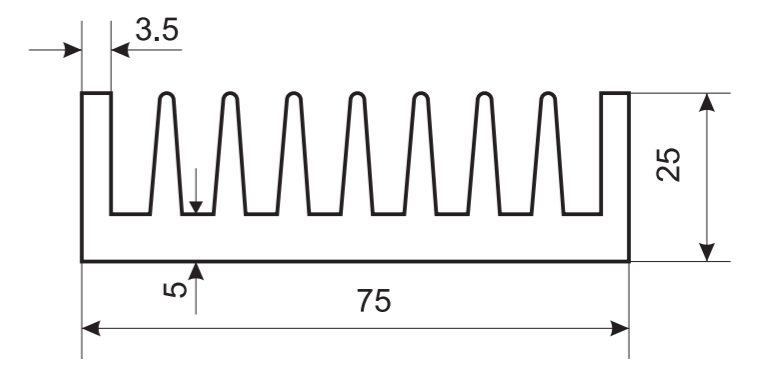

BLA-149

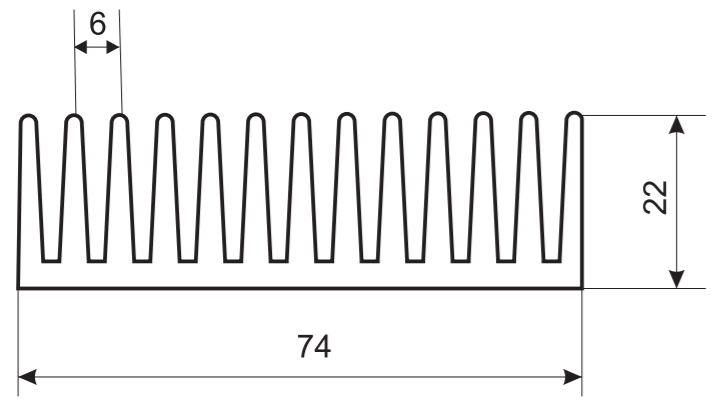

BLA-150

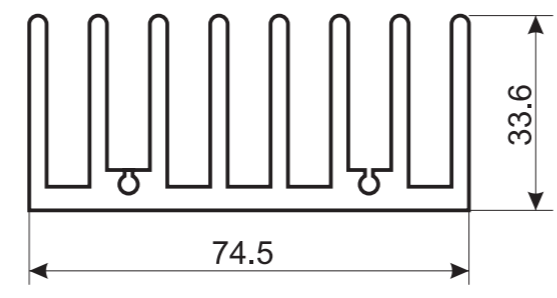

BLA-151

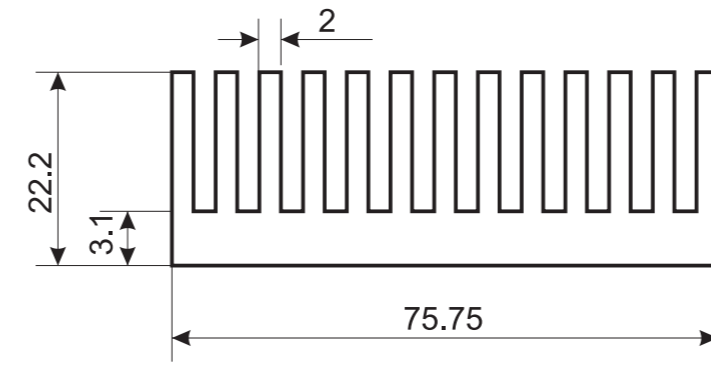

BLA-152

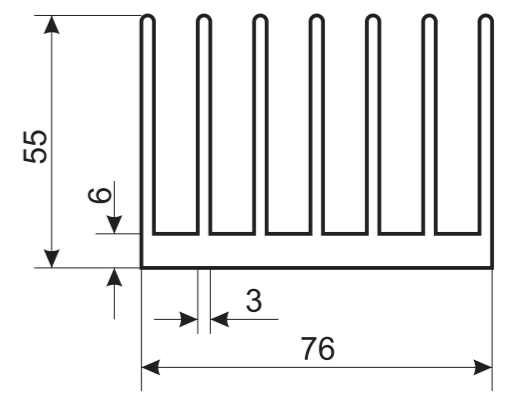

BLA-153

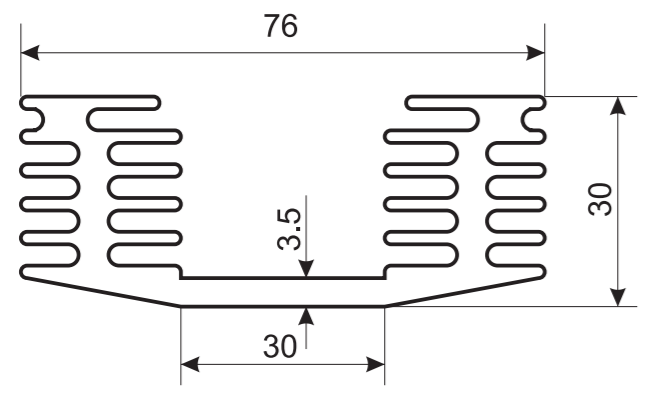

BLA-154

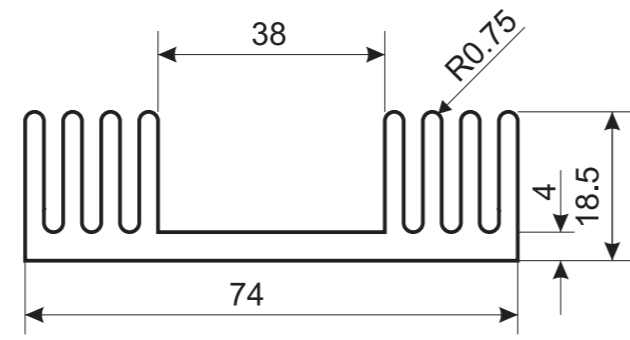

BLA-155

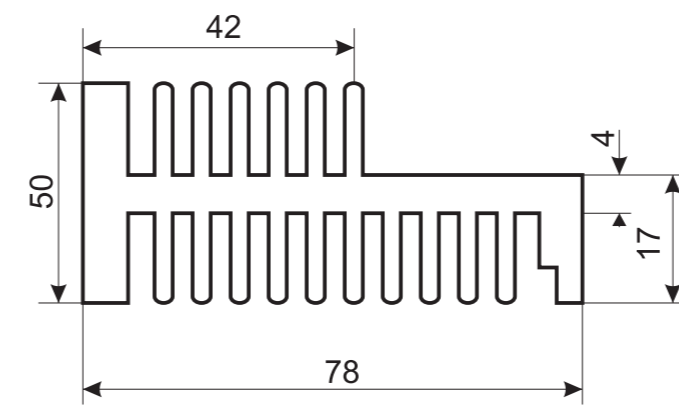

BLA-156

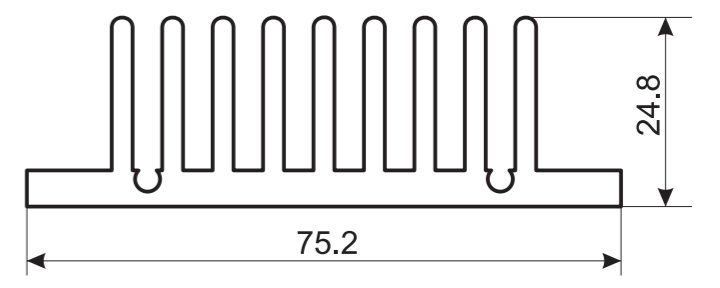

BLA-157

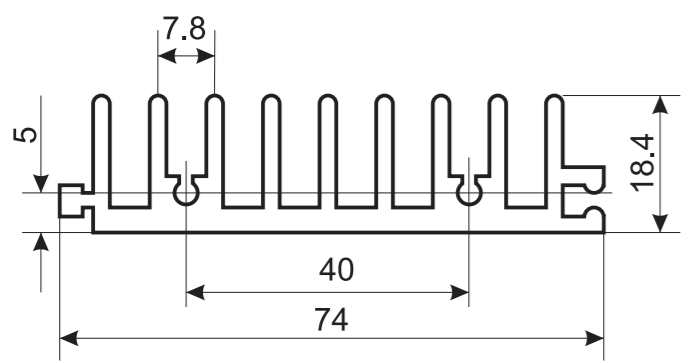

BLA-158

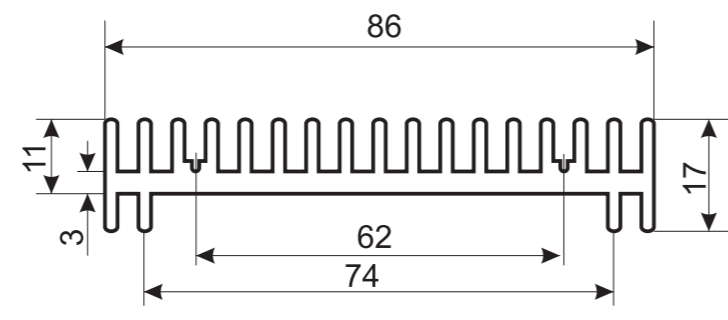

BLA-159

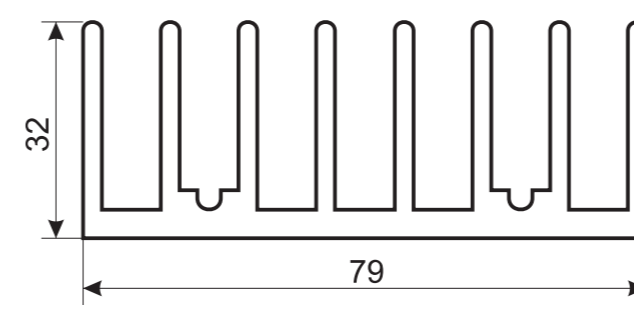

BLA-160

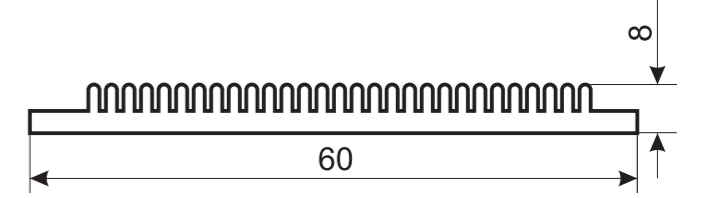

BLA-161

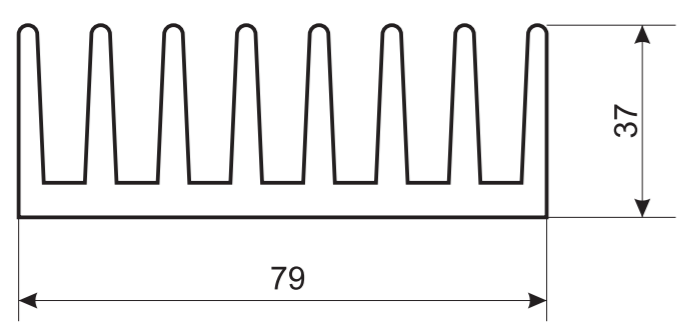

BLA-162

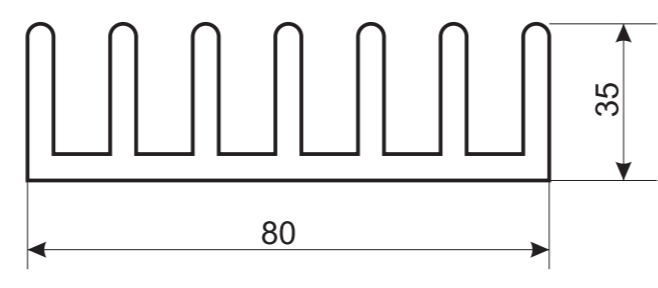

BLA-163

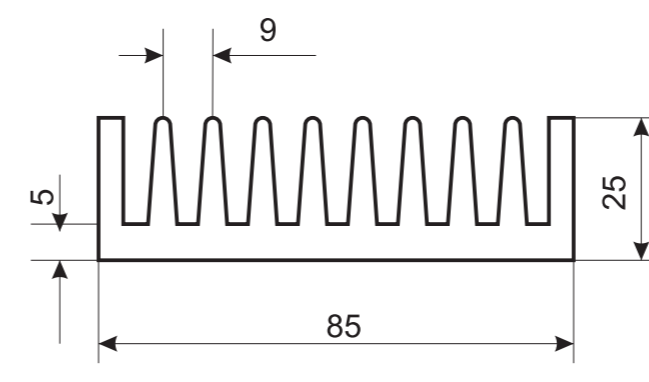

BLA-164

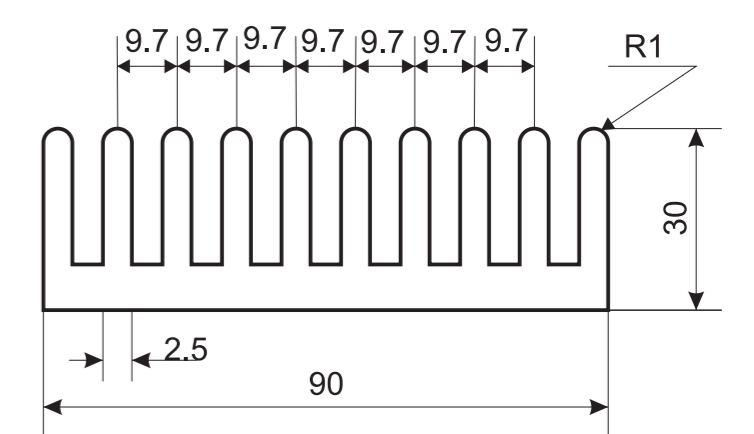

BLA-165

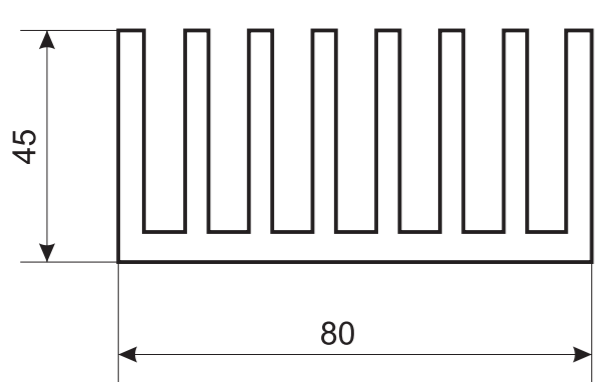

BLA--166

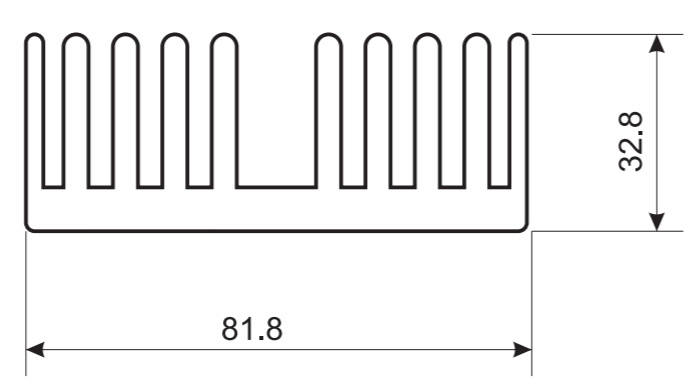

BLA-167

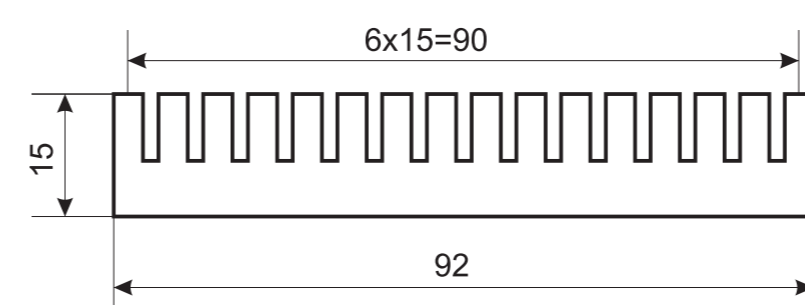

BLA-168

