

BLA-433

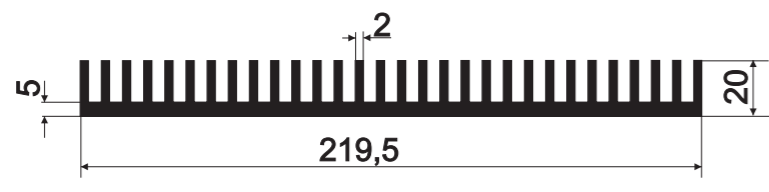

BLA-434

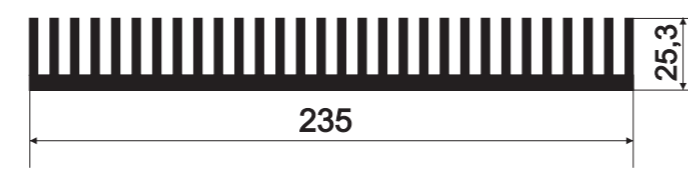

BLA-435

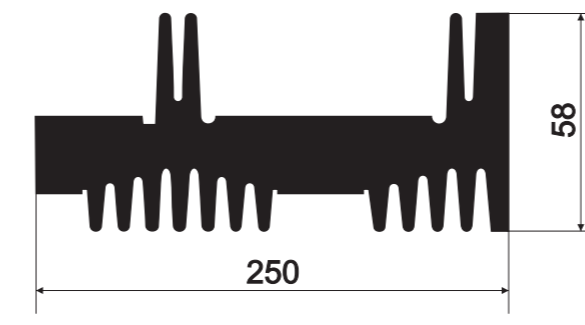

BLA-436

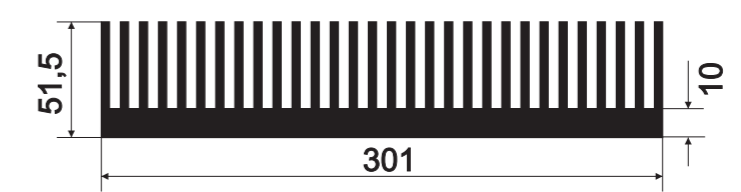

BLA-437

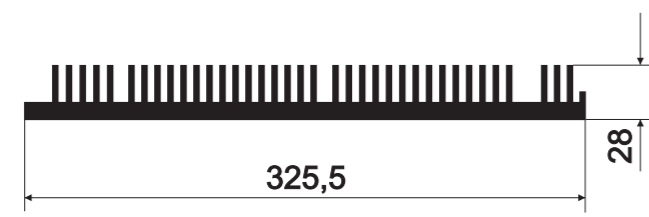

BLA-438

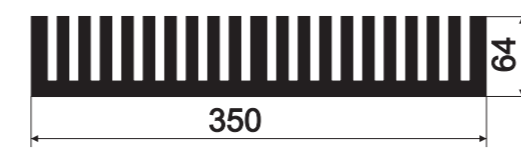

BLA-439

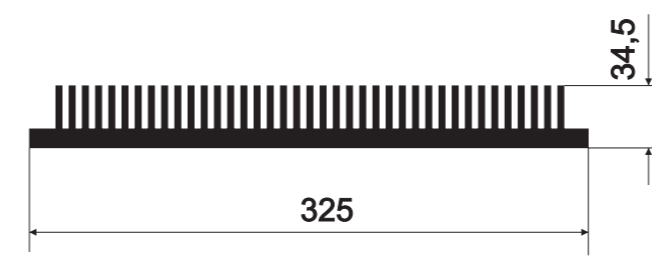

BLA-440

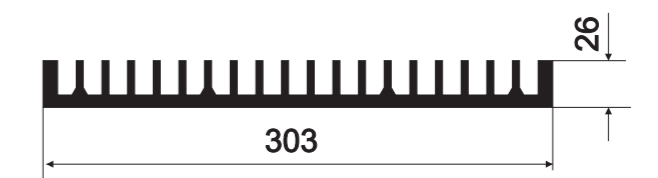

BLA-441



BLA-442

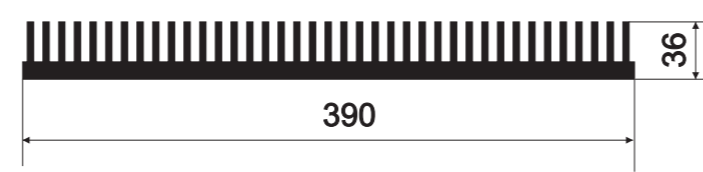

BLA-443

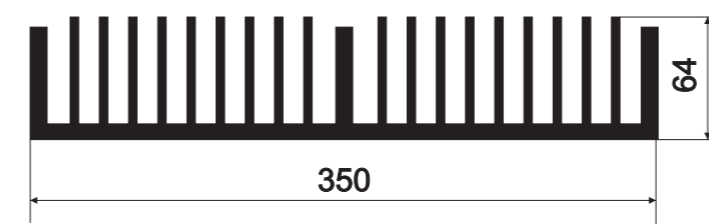

BLA-444

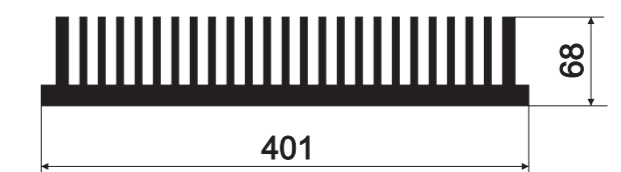

BLA-445

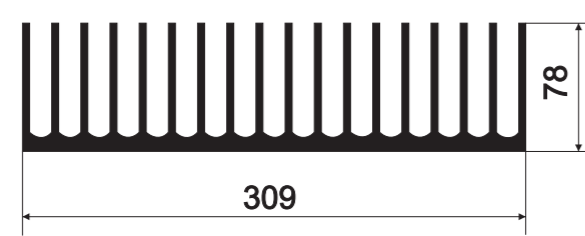

BLA-446

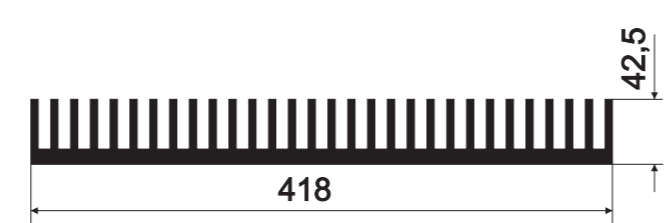

BLA-447

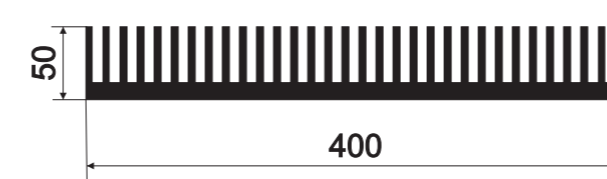

BLA-448

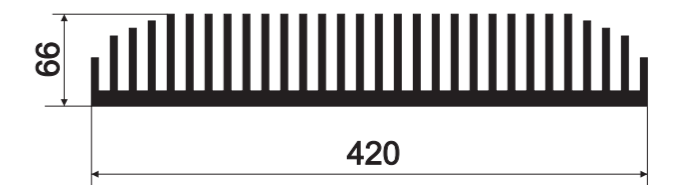

BLA-449

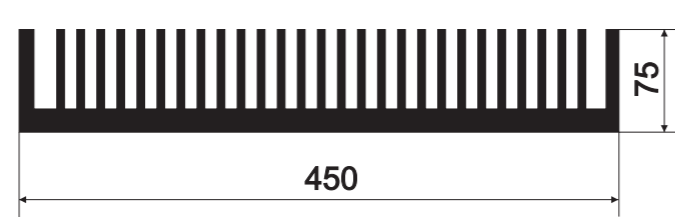

BLA-450

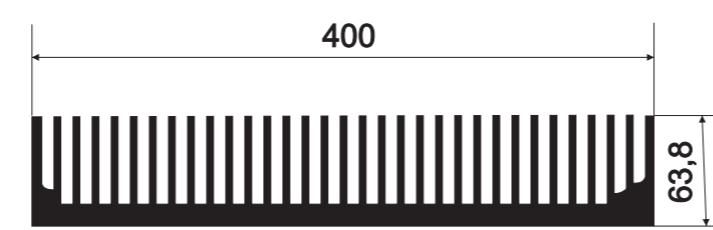

BLA-451

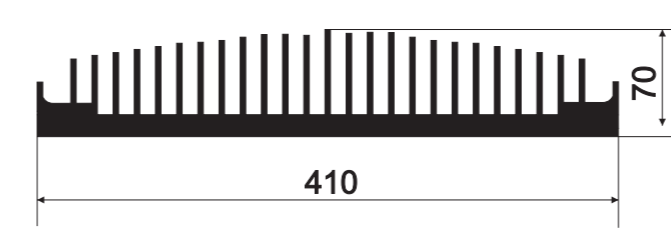

BLA-452

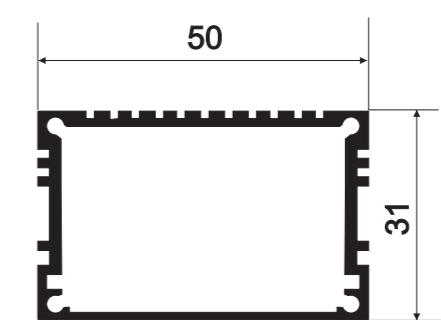

BLA-453

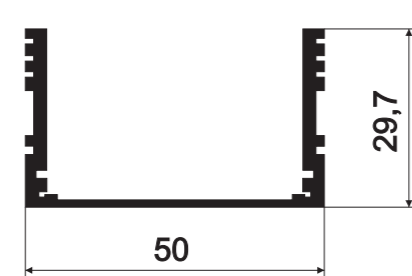

BLA-454

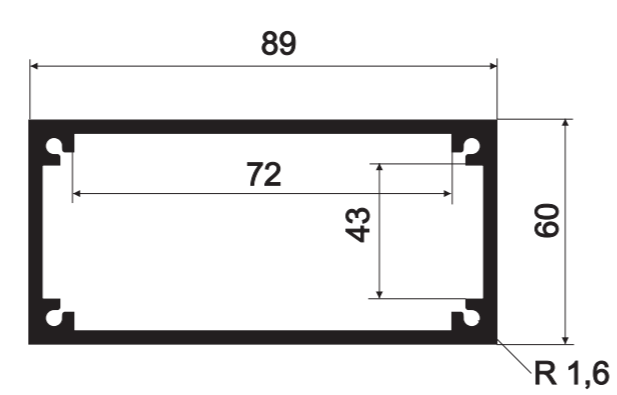

BLA-455

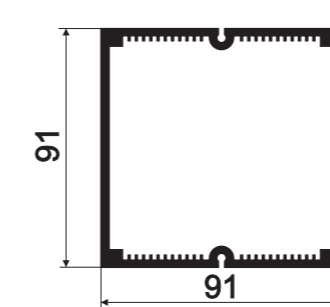

BLA-456

