

BLA-169

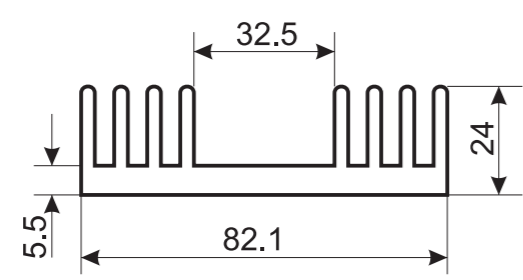

BLA-170

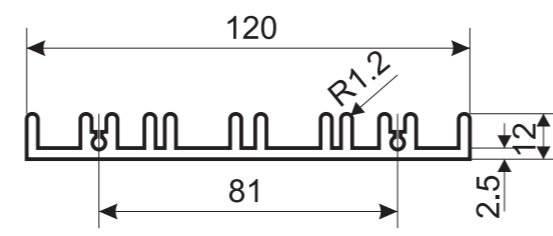

BLA-171

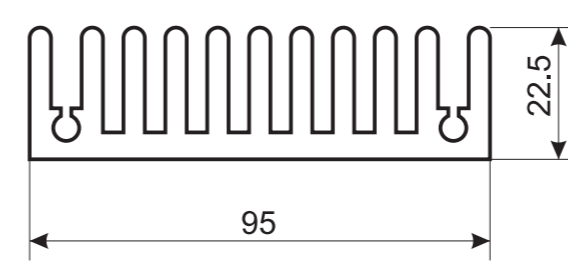

BLA-172

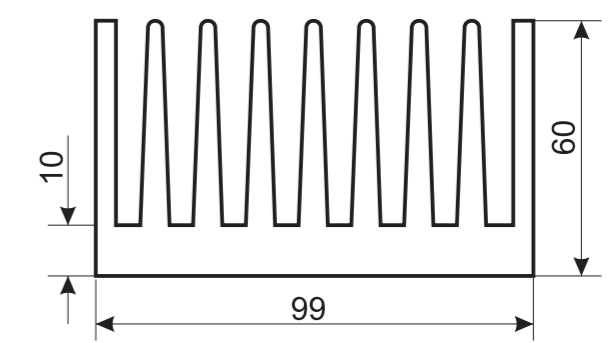

BLA-173

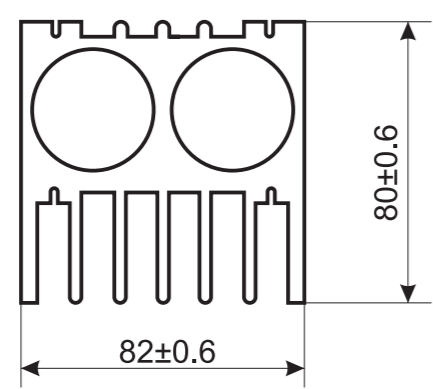

BLA-174

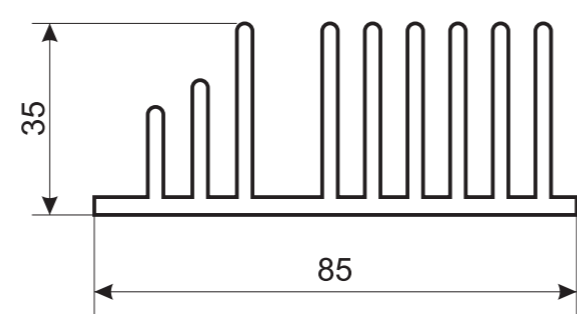

BLA-175

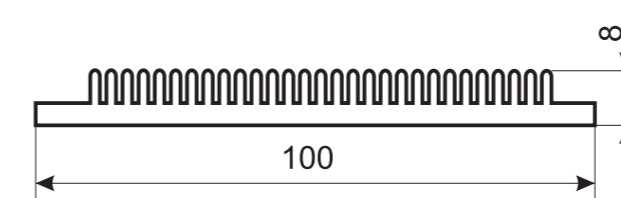

BLA-176

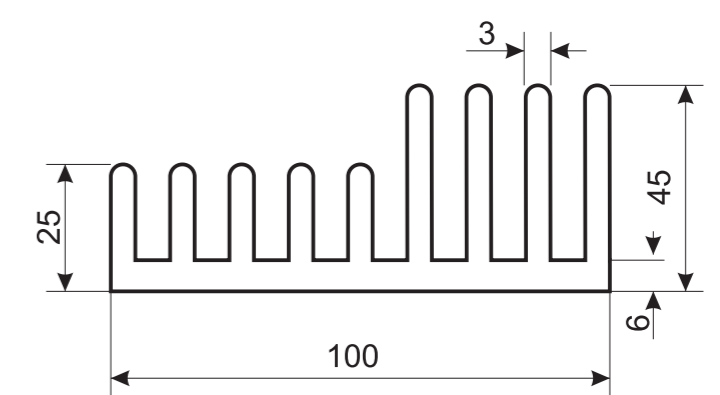

BLA-177

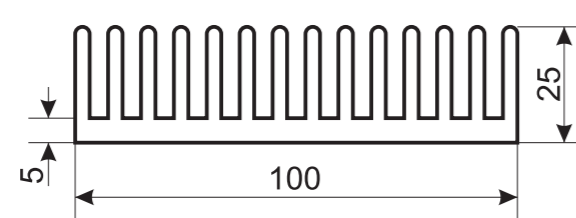

BLA-178

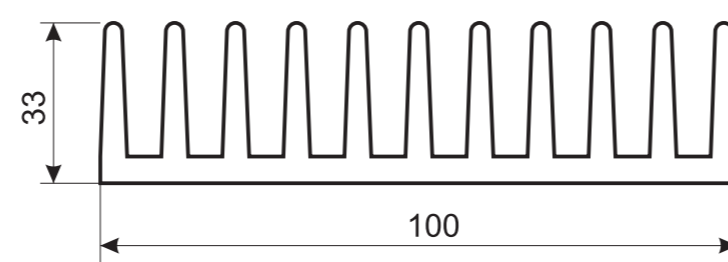

BLA-179

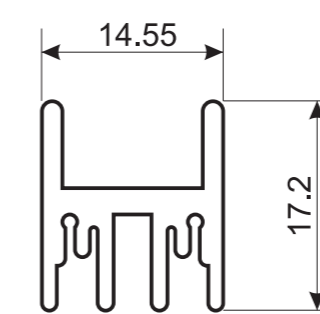

BLA-180

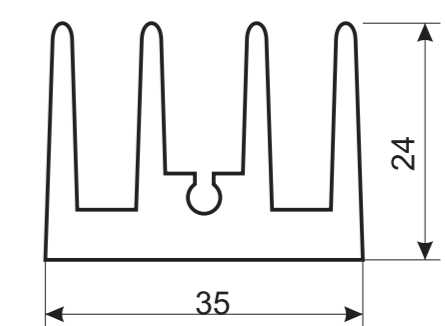

BLA-181

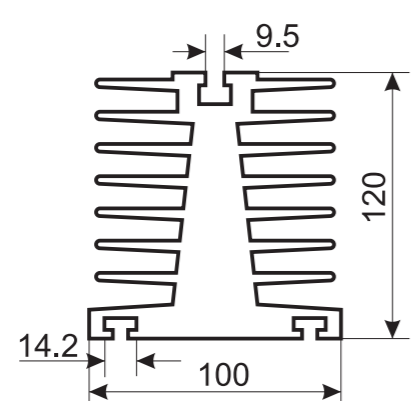

BLA-182

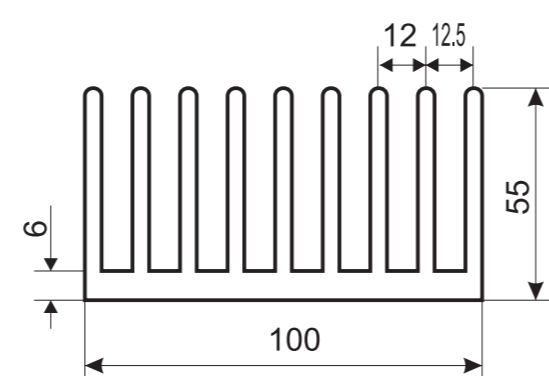

BLA-183

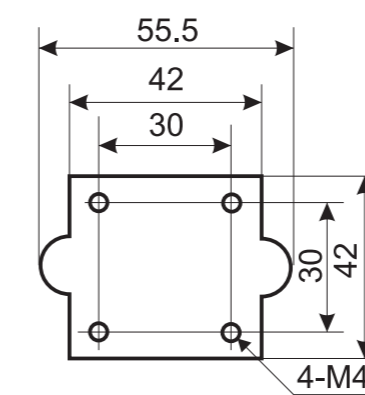

BLA-184

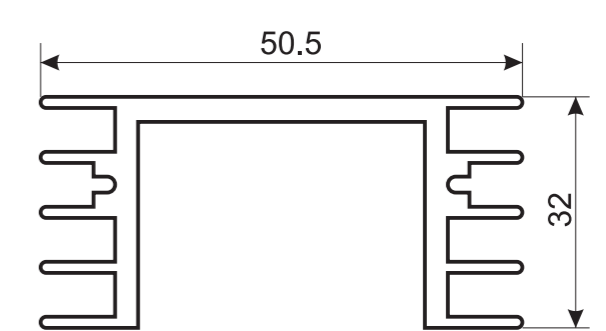

BLA-185

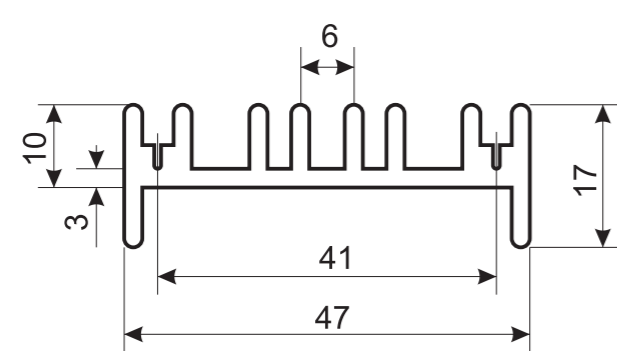

BLA-186

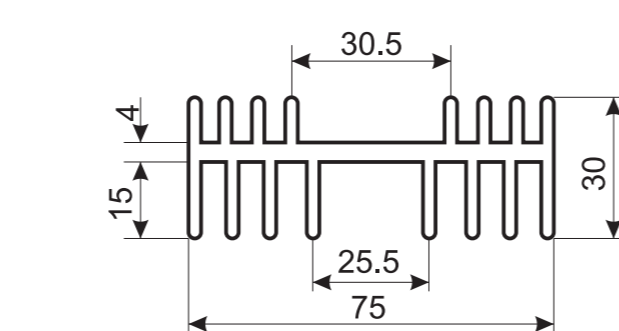

BLA-187

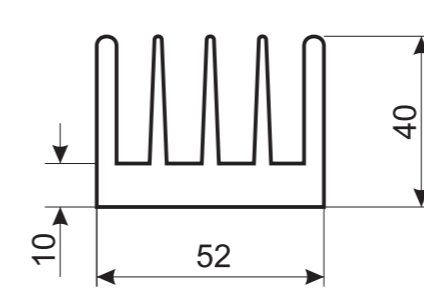

BLA-188

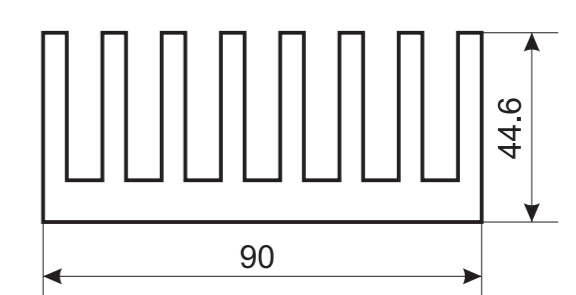

BLA-189

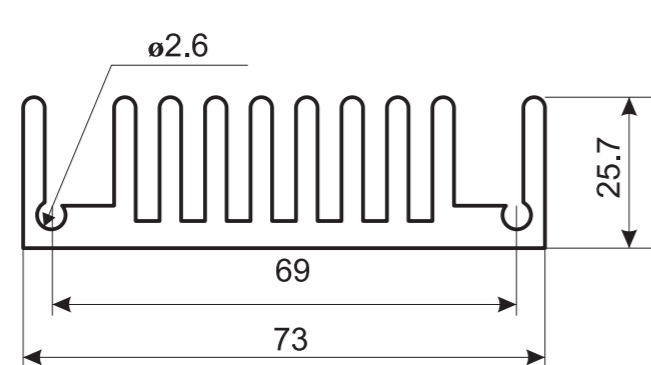

BLA-190

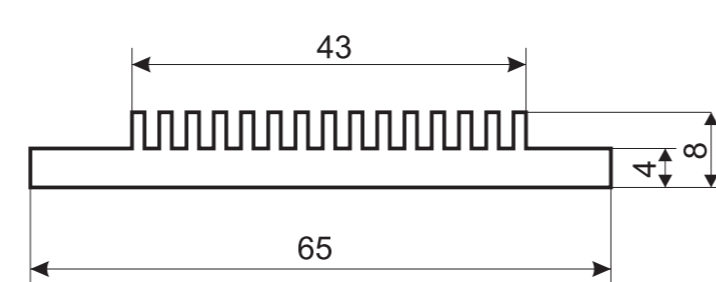

BLA-191

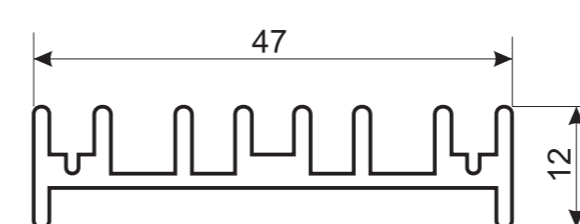

BLA-192

