

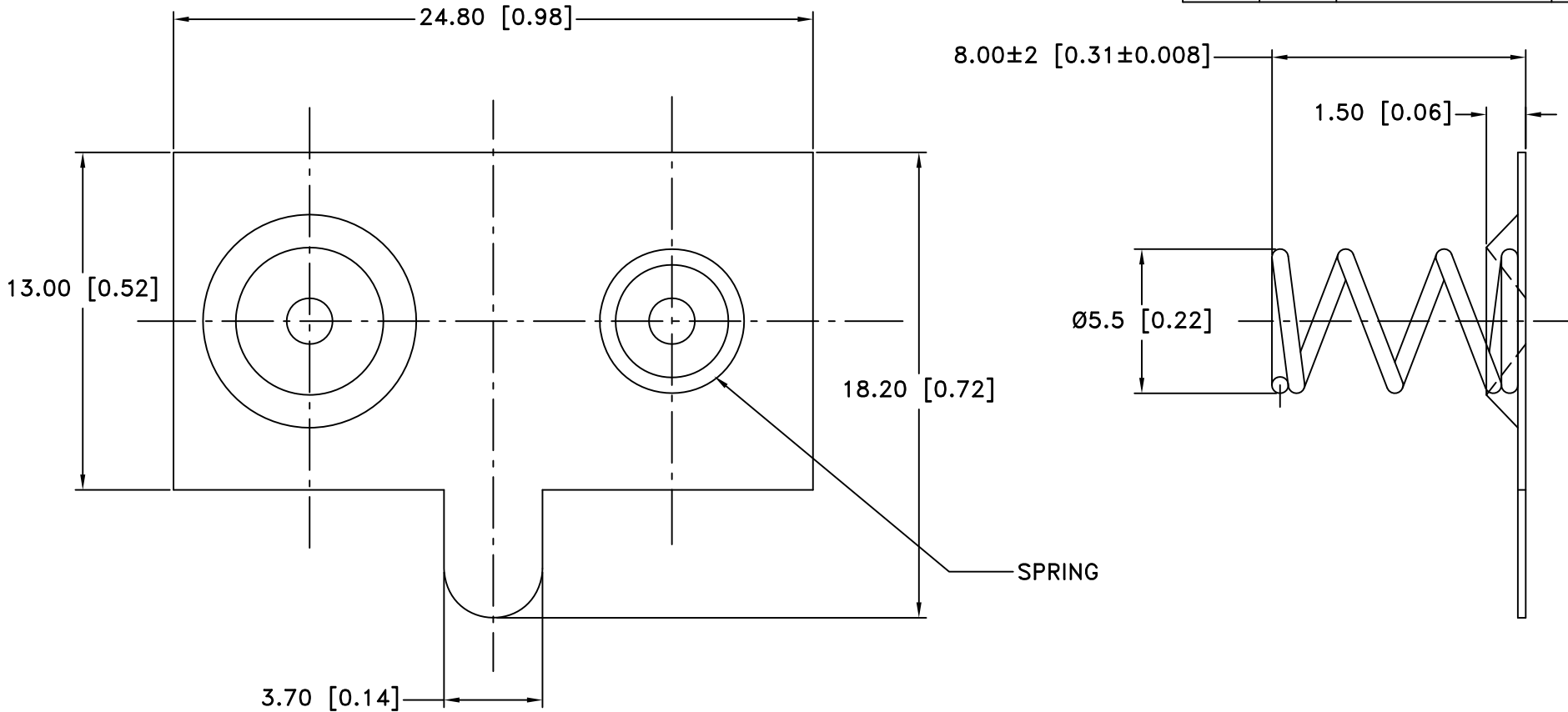

Date	SYM	REVISION RECORD	AUTH	DR.	CK.
08/18/05	A	BASE MATERIAL WAS BRASS	T.B.	B.S.	
08/11/06	B	ADDED "ROHS COMPLIANT"	T.B.	B.S.	
11/21/14	C	UPDATED TO ROHS 2 COMPLIANT	T.B.	B.S.	
03/24/17	D	UPDATED NOTE	T.B.	B.S.	



NOTES:

1. BASE: STEEL, 0.3mm (0.012") THICK. ELECTROLYTIC BRIGHT TIN PLATED.
2. SPRING: SWG 60C ELASTIC STEEL, 0.61mm (0.024") THICK. NICKEL PLATED.
3. ROHS 2 COMPLIANT

Tolerance (Except as noted)	 Memory Protection Devices, Inc 200 Broad Hollow Road, Farmingdale, New York 11735		
decimal ±.5 (.020)		Scale	Drawn By B.S.
Fractional ± .8 (.030)	Title "AA" BATTERY COMMON CONTACT		
Angular ± 3°	Date 03/24/17	Drawing Number SN-T5-3	