



# JQX-13F

CCC 03001003500 10002045756  
 R50126378 cRU us E158859

1C,2C:28×21.5×35.5 3C:28×31.5×36 4C:28×41.5×36

Features	
<ul style="list-style-type: none"> <li>Small size, light weight, heavy reverse power.</li> <li>Optional mounting ways.</li> <li>Firm structure, strong anti-shock &amp; anti vibration.</li> <li>Suitable for automatic control, telecommunication equipment, household electrical appliances and machinery electrical facilities.</li> </ul>	

Ordering Information	
<b>JQX-13F 2C a DC12V 1 L</b>	
1 Part number: JQX-13F	5 Cover: 1:1Mode; 2:2 Mode
2 Contact arrangement: 1A:1A; 2A:2A; 3A:3A; 1B:1B; 2B:2B; 3B:3B; 1C:1C; 2C:2C; 3C:3C; 4A:4A; 4B:4B; 4C:4C	6 Coil transient suppression: L:with LED; D:with diode; LD:with LED & diode; NIL:standard
3 Terminal: a:inserting type; b:PCB type	
4 Coil rated voltage(V): AC:6,12,24,36,48,110,120,220,240	
	DC:6,12,24,36,48,110,220

Contact Data	
Contact Material	AgCdO AgSnO <sub>2</sub>
Contact Arrangement	1A(1H)(SPSTNO) 2A(2H)(DPSTNO) 3A(3H)(SPSTNO) 4A(3H)(SPSTNO) 1B(1D)(SPSTNC) 2B(2D)(DPSTNC) 3B(3D)(SPSTNC) 4B(3D)(SPSTNC) 1C(1Z)(SPDT(B-M)) 2C(2Z)(DPDT(B-M)) 3C(3Z)(3PDT(B-M)) 4C(4Z)(4PDT(B-M))
Contact Rating	Resistive 15A, 20A/277VAC, 28VDC 10A/277VAC, 12A/250VAC, 28VDC
	Motor load 1/3 HP 120VAC 240VAC 1/3 HP 120VAC 240VAC 1/3HP 125VAC 1/2 HP 125VAC
Coil power	DC 0.9W 0.9W 1.4W 1.5W
	AC 1.2VA 1.2VA 2VA 2.5VA
Max. Switching Voltage	30VDC 300VAC
Max. Switching Power	560W 5540VA Max. Switching Current:20A
Max. Resistance or Voltage drop	≤50mΩ Item 4.12 of IEC 61810-7
Operational life	Electrical 10 <sup>5</sup> Item 4.30 of IEC 61810-7
	Mechanical 2 × 10 <sup>7</sup> Item 4.31 of IEC 61810-7

Dash numbers	Coil voltage V		Coil resistance Ω ±10%	Pick up voltage V(max) (80%of rated voltage)	Release voltage V(min) (10%of rated voltage)	Coil power W	Operate Time ms	Release Time ms
	Rated	Max.						
006-900	6	6.6	40	4.8	0.6	0.9	<25	<25
012-900	12	13.2	160	9.6	1.2			
024-900	24	26.4	640/650	19.2	2.4			
036-900	36	39.6	1440	28.8	3.6			
048-900	48	52.8	2600	38.4	4.8			
110-900	110	121	11000	88.0	11.0			
220-900	220	242	53778	176	22.0			
012-1400	12	13.2	107	9.6	1.2	1.4	<25	<25
024-1400	24	26.4	410	19.2	2.4			
036-1400	36	39.6	926	28.8	3.6			
048-1400	48	52.8	1700	38.4	4.8			
110-1400	110	121	8500	88.0	11.0			
220-1400	220	242	34571	176	22.0			
012-1500	12	13.2	100	9.6	1.2	1.5	<25	<25
024-1500	24	26.4	350	19.2	2.4			
036-1500	36	39.6	865	28.8	3.6			
048-1500	48	52.8	1600	38.4	4.8			
110-1500	110	121	6900	88.0	11.0			
220-1500	220	242	32267	176	22.0			

CAUTION: 1.The use of any coil voltage less than the rated coil voltage will compromise the operation of the relay.  
 2.Pickup and release voltage are for test purposes only and are not to be used as design criteria.

### Coil Parameter (AC)

Dash numbers	Coil voltage V		Coil resistance Ω ±10%	Rated current mA	Pick up voltage V(max) (80%of rated voltage)	Release voltage V(min) (30%of rated voltage)	Coil power VA
	Rated	Max.					
006AC-1200	6	6.6	11.5	183.0	4.8	1.8	1.2
012AC-1200	12	13.2	46	91.0	9.6	3.6	
024AC-1200	24	26.4	184	46.0	19.2	7.2	
036AC-1200	36	39.6	320	33.0	28.8	10.8	
048AC-1200	48	52.8	735	24.0	38.4	14.4	
110AC-1200	110	121	3900	11.0	88.0	33.0	
120AC-1200	120	132	4550	9.8	96.0	36.0	
220AC-1200	220	242	14400	5.5	176	66.0	
240AC-1200	240	312	19000	4.2	192	72.0	
012AC-2000	12	13.2	24	167	9.6	3.6	
024AC-2000	24	26.4	100	83	19.2	7.2	
036AC-2000	36	39.6	230	56	28.8	10.8	
048AC-2000	48	52.8	410	42	38.4	14.4	
110AC-2000	110	121	2300	18	88.0	33.0	
220AC-2000	220	242	8600	9.1	176	66.0	
240AC-2000	240	312	12100	6.2	192	72.0	
012AC-2500	12	13.2	20	208	9.6	3.6	2.5
024AC-2500	24	26.4	78	104	19.2	7.2	
036AC-2500	36	39.6	180	69	28.8	10.8	
048AC-2500	48	52.8	350	52.1	38.4	14.4	
110AC-2500	110	121	1600	22.7	88.0	33.0	
220AC-2500	220	242	6700	11.4	176	66.0	
240AC-2500	240	312	9120	9.8	192	72.0	

CAUTION: 1.The use of any coil voltage less than the rated coil voltage will compromise the operation of the relay.  
 2.Pickup and release voltage are for test purposes only and are not to be used as design criteria.

### Operation condition

Insulation Resistance <sup>1)</sup>	1000MΩ min (at 500VDC)	Item 7 of IEC 60255-5
Dielectric Strength <sup>1)</sup>		
Between contacts	50Hz 1000V	Item 6 of IEC 60255-5
Between contact and coil	50Hz 1500V	Item 6 of IEC 60255-5
Shock resistance	100m/s <sup>2</sup> 11ms	IEC 68-2-27 Test Ea
Vibration resistance	10Hz~55Hz double amplitude 1.5mm	IEC 68-2-6 Test Fc
Terminals strength	8N 4N(PC type)	IEC 68-2-21 Test Ua2
Solderability	235℃ ± 2℃ 3s ± 0.5s	IEC 68-2-20 Test Ta method 1
Ambient Temperature	-40℃~70℃; -25℃~70℃(3C,4C)	
Relative Humidity	85% (at 30℃)	IEC 68-2-3 Test Ca
Mass	37g(1C,2C);50g(3C);70g(4C)	

Note: 1). When testing, coil terminals should be connected, if LED is installed in relay.

### Safety approvals

Safety approval	UL&CUR	TiV	CQC
Load	1A,1B,1C:20A/277VAC,28VDC 1/3 HP120VAC,240VAC 2A,2B,2C,3A,3B,3C,4A,4B,4C: 10A/277VAC,12A/250VAC,28VDC 1/2 HP 125VAC 2A,2B,2C: 1/3 HP120VAC,240VAC	10A/277VAC,28VDC	10A/220VAC 10A/277VAC

## Dimensions

mm /inch

1 model

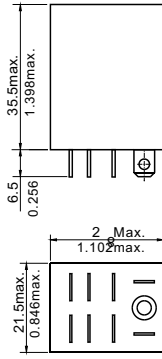

2 model

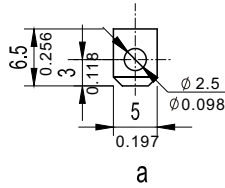
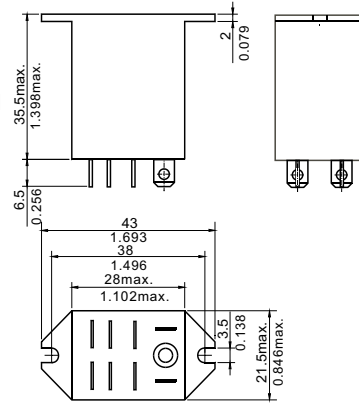

Inserting type

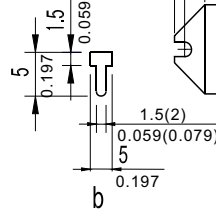

PCB type

Leading end shape diagram  
Dimensions

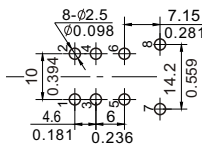

1C

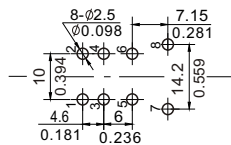

2C

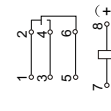

1C

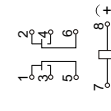

2C

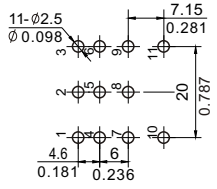

3C

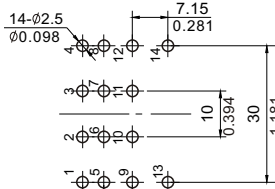

4C

Mounting (Bottom view)

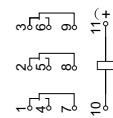

3C



4C

Wiring diagram  
(Bottom view)

- NOTES 1).Dimensions are in millimeters.  
2).Inch equivalents are given for general information only.

## Reference Data

