



HJQ-22F

SPECIFICATION

FILE NUMBER: P-08KD401A

DATE: 2001/11/02



■ Features

- 4 pole configurations
- Au-clad contact available

■ CONTACT DATA

| | | |
|----------------------------|-----------------|-----------------------------------|
| Contact Form | 4C/2C | |
| Contact Material | AgCdO | |
| Contact Ratings | 5A 240VAC/30VDC | |
| Max Switching Voltage | 250VAC/30VDC | |
| Max Switching Current | 5A | |
| Max Switching Power | 1750VA/210W | |
| Contact Resistance | 100m Ω Max | at 6VDC 1A |
| Life Expectancy Electrical | 100,000 | Operations(at30Operations/minute) |
| Machanical | 10,000,000 | Operations |

■ GENERAL DATA

| | | |
|---|-------------------------|------|
| Insulation Resistance | 100MΩ Min at 500VDC | |
| Dielectric Strength Between Open Contacts | 1000VAC(for one minute) | |
| Between Contacts and coil | 1500VAC(for one minute) | |
| Operate Time | 25ms | |
| Release Time | 25ms | |
| Temperature Range | -40°C to+70 °C | |
| Shock Resistance | Operating Extremes | 20G |
| | Damage Limits | 100G |
| Vibration Resistance | 10-55Hz,1.5mm | |
| Humidity | 40-85% | |
| Weight | Approx 35g | |
| Safety Standard | CSA:203664 UL:E209198 | |



■ COIL DATA(4Z)

| Nominal Voltage | | Coil Resistance at 20±10%(Ω) | | Max Operate Voltage | | Min Release Voltage | | Max Applicable Voltage | |
|-----------------|----------|------------------------------|-----------|---------------------|------|---------------------|-----|------------------------|---------|
| 5-110VDC | 6-240VAC | VDC | VAC | VDC | VAC | VDC | VAC | VDC | VAC |
| | | 0.9W | 1.2VA | | | | | | |
| 5 | 6 | 27.5 | 11.5 | 3.75 | 4.8 | 0.5 | 0.6 | 6.5 | 7.8 |
| 6 | 12 | 40 | 46 | 4.5 | 9.6 | 0.6 | 1.2 | 7.8 | 15.6 |
| 12 | 24 | 160 | 184 | 9 | 19.2 | 1.2 | 2.4 | 15.6 | 31.2 |
| 24 | 48 | 650 | 735 | 18 | 38.4 | 2.4 | 4.8 | 31.2 | 62.4 |
| 48 | 110 | 2600 | 4550±15% | 36 | 88 | 4.8 | 11 | 62.4 | 143 |
| 110 | 120 | 11000 | 4550±15% | 82.5 | 96 | 11 | 12 | 143 | 156 |
| | 220/240 | | 14400±15% | | 176 | | 24 | | 286/312 |

■ ORDERING CODE

HJQ-22F-12VDC-4Z(P)---1---F--D

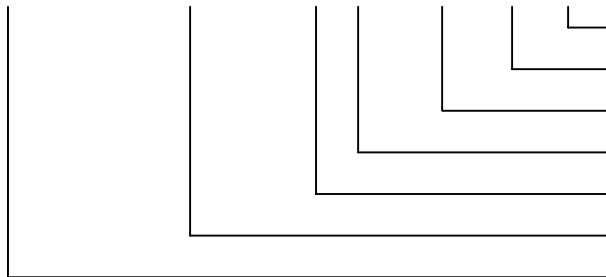

- With LED
- With Flange for 38mm pitch hole
- Bifurcated moving spring
- P: PCB Type Nil: B Type
- 2Z Form 2C 4Z Form 4C
- Coil Nominal Voltage
- Relay Model

OVERALL AND MOUNTING DIMENSIONS

MOUNTING COVER

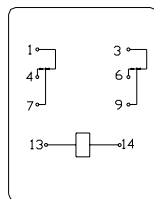
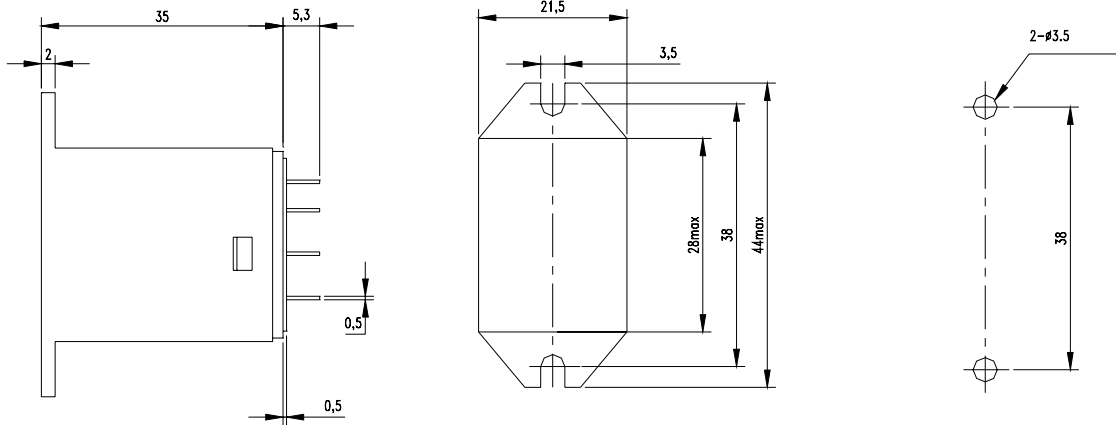

2C Terminal Arrangement/
Internal Connections
(Bottom view)

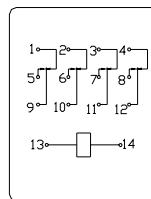

4C Terminal Arrangement/
Internal Connections
(Bottom view)

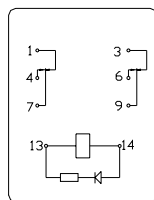

2CD

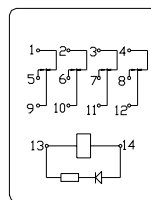

4CD



B Type Terminals

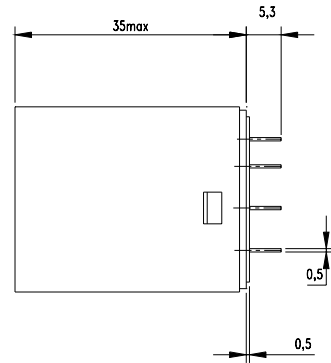
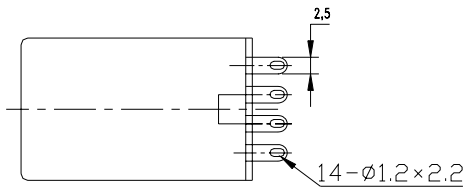

P Type Terminals

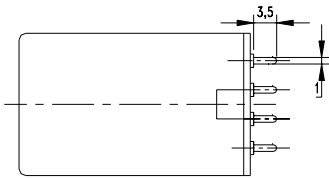

P Type PCB Mounting

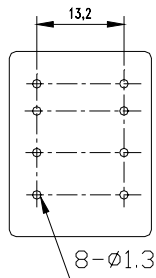
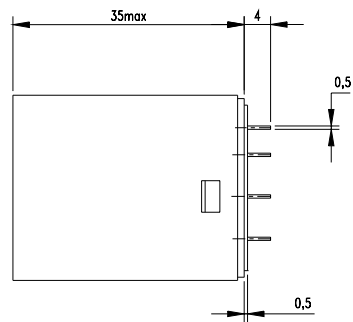

2C

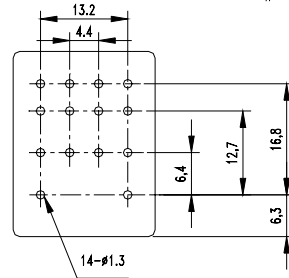

4C

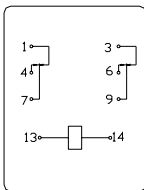

2C Terminal Arrangement/
Internal Connections
(Bottom view)

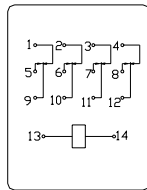

4C Terminal Arrangement/
Internal Connections
(Bottom view)

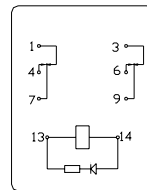

2CD

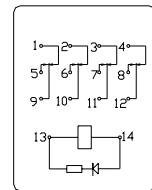

4CD