

UL,C-UL File No.:E179745
TUV File No.:40009320
CQC File No.:CQC03001007667

- 2 poles 3 poles and 4 poles are prepared with switching current of 7A(2 poled and 3 poled), 5A(4 poles).
- printed circuit board terminal use and soldering lug mount, flange case type is prepared.
- Low coil power consumption with high response time.
- High reliability and long life with better vibration and shock resistance.

SPECIFICATIONS

Contact

Arrangement	2a,2c,3a,3c, 4a,4c	
Contact resistive (By voltage drop 1A 6VDC)	50mΩ Max.	
UL/C-UL rating		
Resistive load (cos φ =1)	5A	250VAC
	5A	28VDC
Inductive load (cos φ =0.75~0.8)	2A	250VAC
VDE rating	4C	
	3A/250VAC	3A/30VDC
CQC rating	5A/40A	250VAC
Max.switching voltage	250VAC	28VDC
Max.switching current	5A	
Max.switching power	1,250VA	140W
Expected life(min.ope)	Mechanical (at 120 cpm)	1X10 ⁷
	Electrical (at 20 cpm)	1X10 ⁵

Characteristics

Operate time	25 msec. Max.	
Release time	25 msec. Max.	
Operating humidity	45~85% RH	
Initial breakdown voltage	Between contact and coil	1,500VAC (50/60Hz) for 1 min.
	Between open contacts	1,000VAC (50/60Hz) for 1 min.
Insulation resistance	500MΩ Min.(500VDC)	
Ambient temperature	-25℃ ~+55℃	
Shock resistance	Functional	10G Min.
	Destruction	100G Min.
Vibration resistance	Functional	10 TO 55 Hz at double Amplitude of 1.5mm
	Destruction	10 TO 55 Hz at double Amplitude of 1.5mm
Unit weight	Approx. 40g	

Coil

Nominal operating power	0.9W, 1.0-1.3VA
-------------------------	-----------------

TYPICAL APPLICATION

Vending machines, cooking appliances, office machines, domestic appliances, control equipment, etc

ORDERING INFORMATION

	SMET	2	12	D	M	T	
Type	Number of pole	Coil type		Coil voltage		Contact form	Terminal
SMET	2:2 pole 3:3 pole 4:4 pole	DC: 06,12,24,48,110 AC: 06,12,24,48,110,220		A:AC D:DC		M:1 Form A N:1 Form C	P: Pc Board T: plug-in F: Flange case & Plug-in

COIL(at 20°C)

SMET

Type	Voltage code	Nominal voltage (VDC)	Nominal current (mA)		Coil resistance ($\Omega \pm 10\%$)	Drop-out voltage (VDC)	Pick-up voltage (VDC)	Nominal operating power (W)	Max allowable voltage (VDC)
			50HZ	60HZ					
AC	06	6	220.0	170.0	11.5	30%Min.	80%Max.	Abt. 1.0 to 1.3VA	130% of nominal voltage
	12	12	110.0	8.0	46				
	24	24	60.0	45.0	165				
	48	48	30.0	23.0	735				
	110/120	120	13.5	11.5	4430				
	220/240	220/240	6.0	5.0	14,400				
DC	06	6	150.0		40	10%Min.	75%Max.	Abt.0.9	130% of nominal voltage
	12	12	75.0		160				
	24	24	36.9		650				
	48	48	18.5		2,600				
	110	110	10.0		11,000				

OUTLINE DIMENSIONS, WIRING DIAGRAM AND PC BOARD LAYOUT(unit:mm)

Wiring Diagram

4 pole plug in terminal

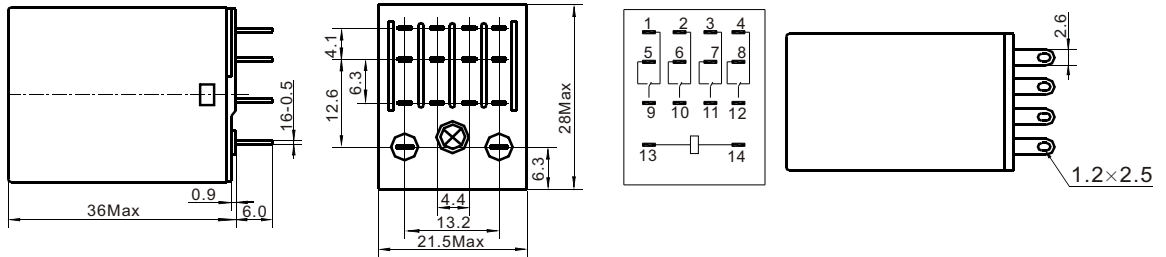

2 pole plug in terminal

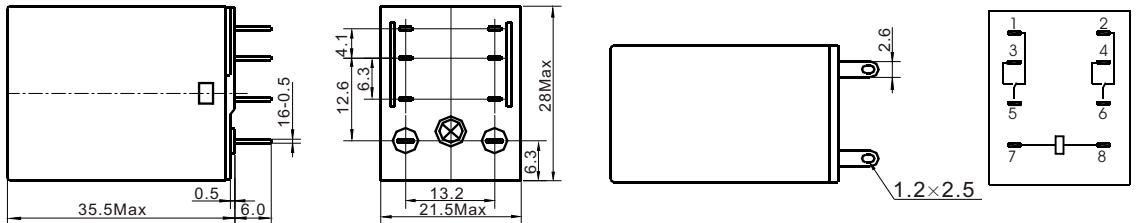

3 pole plug in terminal

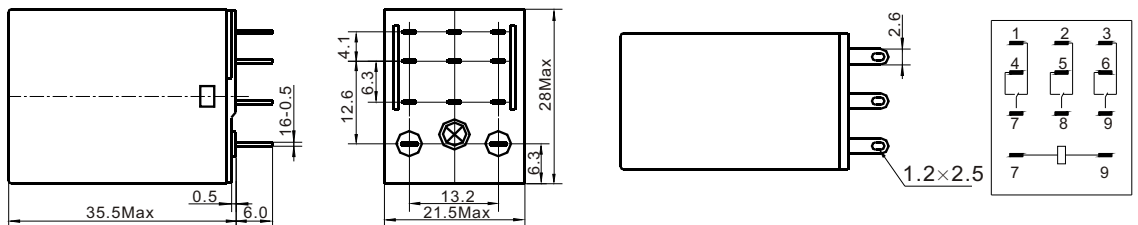

2 pole PCB terminal
 3 pole PCB terminal
 4 pole PCB terminal

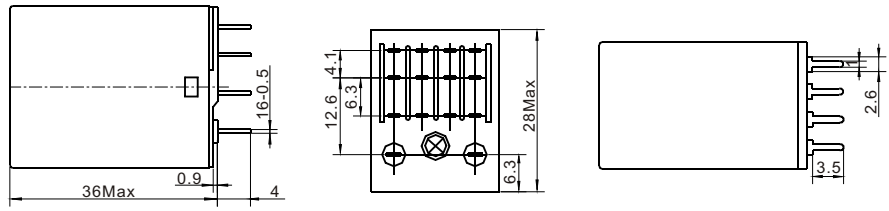

PCB layout

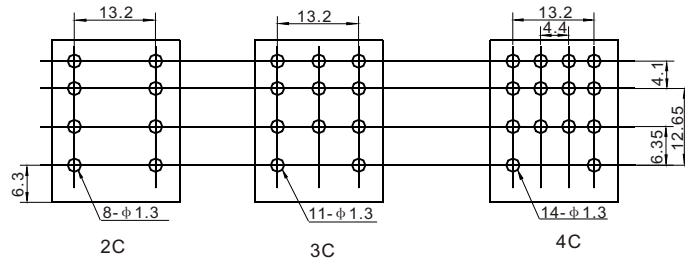

2 pole Flange case and plug in terminal
 3 pole Flange case and plug in terminal
 4 pole Flange case and plug in terminal

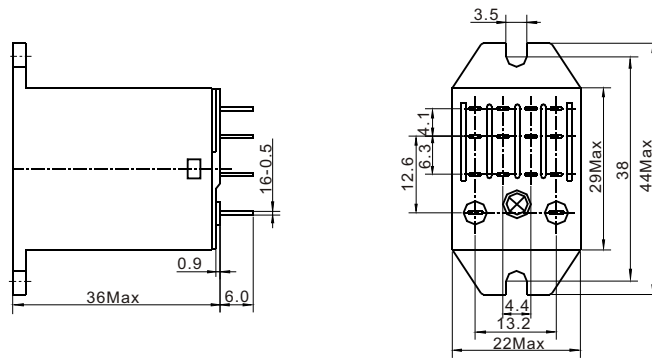

CHARACTERISTICS CURVE

MAXIMUM SWITCHING POWER

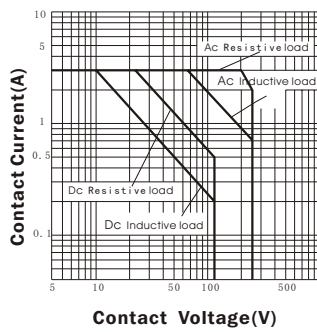

LIFE CURVE

