

Q-10043

TYPE: **CDR-3302**



SPECIFICATIONS

Contact Type	(SPCO)
Rating	DC 12V, 100mA
Contacts Resistance	100mΩ Max
Insulation Resistance	100MΩ Min
Minimum Load	DC 100V
Dielectric Strengths	AC 100V / 1 minute
Life Test	50 000 cycles/ minute
Operating temperature range	-40°C to +85°C

Outline Drawing

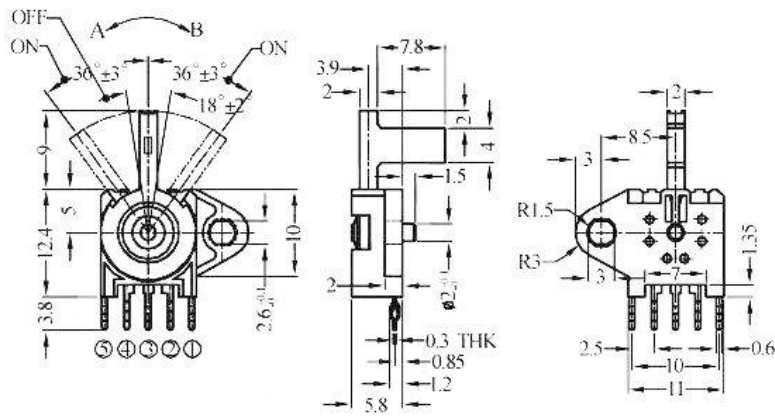

Mounting

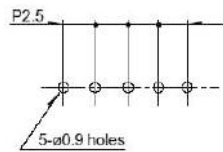

Circuitry

