

## Push-Button Switch

**Q-9308**

TYPE: **PBS-29B**

### SPECIFICATIONS

Rating: 3A 125V AC; 1A 250V AC  
 Contact R: 20mΩ max  
 Insulation R: 500V DC 100MΩ min  
 Dielectric Strength: 1 Minute 1000V AC  
 Operating Temperature: -25°C ~ +85°C  
 Electrical Life: 50, 000 Cycles

Outline Drawing

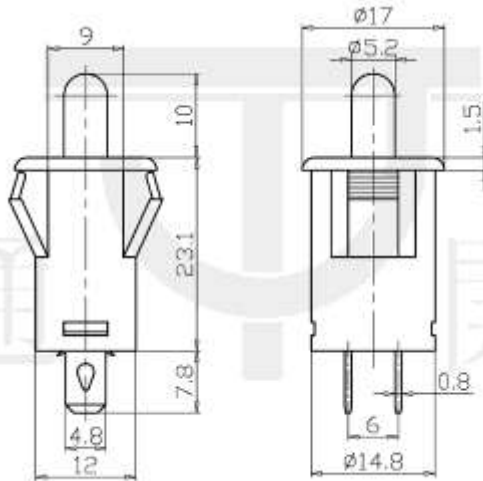

Mounting

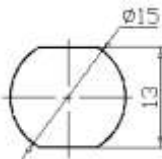

Circuitry

