

Automobile Switch

Q-2859

TYPE: **ASW-11D**

SPECIFICATIONS

Contact Type: SPST
 Rating: 20A 12V DC
 Contact R: 50mΩ max
 Insulation R: 500V DC 100MΩ min
 Dielectric Strength: 1 Minute 1500V AC
 Operating Temperature: -25°C ~ +85°C
 Electrical Life: 10, 000 Cycles

Outline Drawing

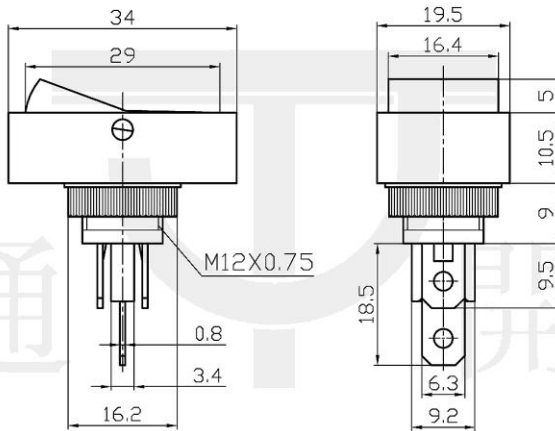

Mounting

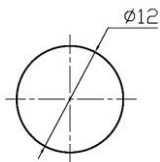

Circuitry

