

Push-Button Switch

Q-2662

TYPE: **PBS-17A-2**

SPECIFICATIONS

Rating: 3A 125V AC; 1A 250V AC
Contact R: 20mΩ max
Insulation R: 500V DC 100MΩ min
Dielectric Strength: 1 Minute 1000V AC
Operating Temperature: -25°C ~ +85°C
Electrical Life: 50, 000 Cycles

Outline Drawing

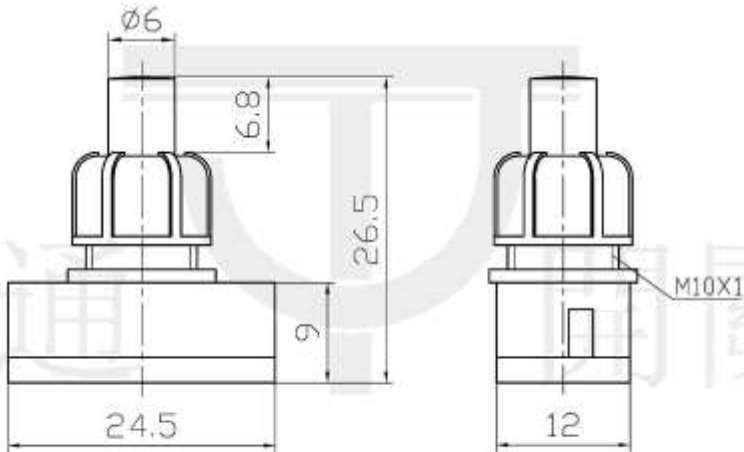

Mounting

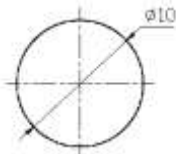

Circuitry

