

# Tact Switch

**Q-579**

TYPE: **IT-1187**

## SPECIFICATIONS

Contact Type	SPST
Rating	DC 12V, 50mA
Contacts Resistance	500mΩ Max
Insulation Resistance	100MΩ Min
Minimum Load	DC 100V
Dielectric Strengths	AC 250V / 1 minute
Life Test	100 000 cycles/ minute
Operating temperature range	-30°C to +85°C

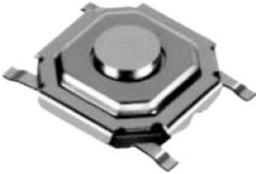

Outline Drawing

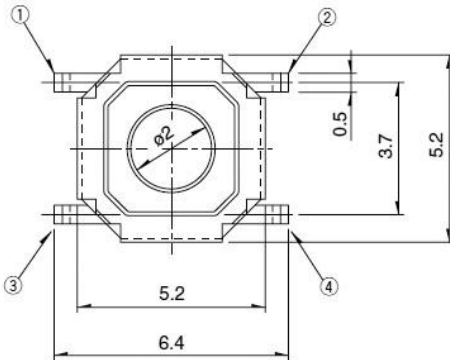

Unit: mm

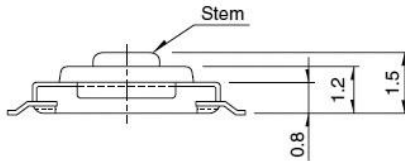

Mounting

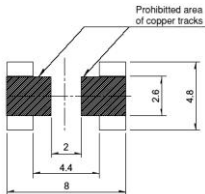

Circuitry

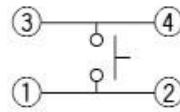

OFF - (ON)

## SOLDERING CONDITIONS

### Condition for Reflow

1. Heating method  
Double heating method with infrared heater.
2. Temperature measurement  
Thermocouple 0.1 to 0.2 Φ CA(K) or CC(T) at solder joints (copper foil surface). A heat resisting tape should be used for fix measurement.
3. Temperature profile
  - (1) The above temperature shall be measured of the top of switch. There are cases where PC board's temperature greatly differs from that of the switch, depending on the material, size, thickness of PC board's and others. Care, should be taken to prevent the switch's surface temperature from exceeding 260°C.
  - (2) Soldering conditions differ depending on reflow soldering machines. Prior verification of soldering condition is highly recommended.

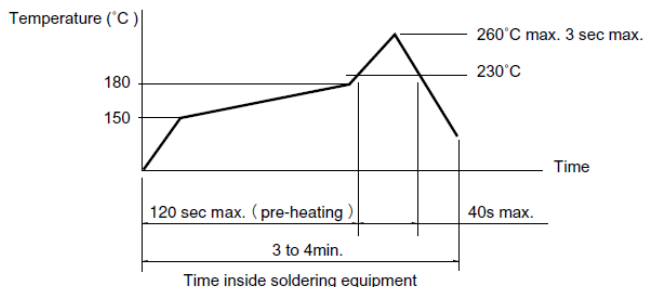

### Manual Soldering

Items	Condition
Soldering temperature	350°C max.
Duration of soldering	3s max.
Capacity of soldering iron	60W max.

1. Consult with us for availability of TACT switch™ washing.
2. Prevent flux penetration from the top side of the TACT switch™.
3. Switch terminals and a PC board should not be coated with flux prior to soldering.
4. The second soldering should be done after the switch returns to normal temperature.

Notes are common to this series/models.

- This site catalog shows only outline specifications. When using the products, please obtain formal specifications for supply.
  - For φ330mm diameter reel requirements, please contact us.
  - This products can be used in vehicles.
- Although these products are designed to perform over a wide operating temperature range, please ensure that you receive and read the formal delivery specifications before use.

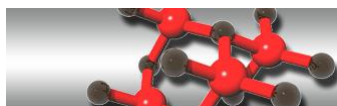

Сеть магазинов  
**КВАРЦ**  
Радиодетали и электронные компоненты

107023, Москва, ул. Буженинова, д. 16  
 телефон: (495) 963-6120  
 факс: (495) 963-4994  
 e-mail: [quartz1@quartz1.ru](mailto:quartz1@quartz1.ru)

111123, Москва, шоссе Энтузиастов, д31  
 телефон/факс: (495) 788-8899 многоканальный  
 e-mail: [mqz@quartz1.ru](mailto:mqz@quartz1.ru)