

PLS-20-GPM

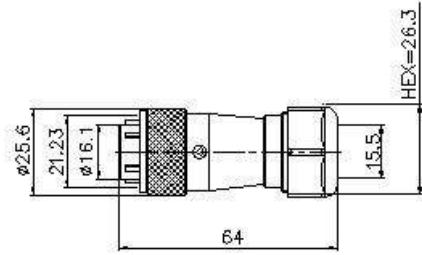

PLS-20-PM

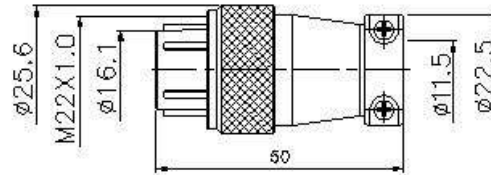

PLS-20-RF

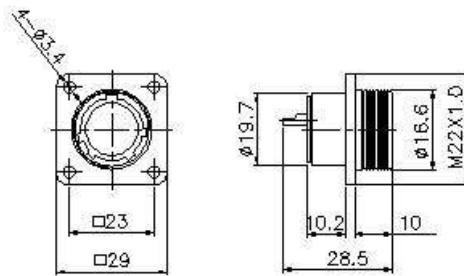

PLS-20-ADF

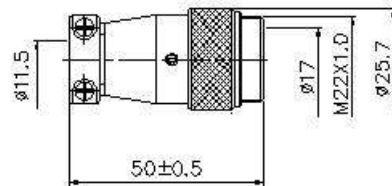

PLS-20-ADM

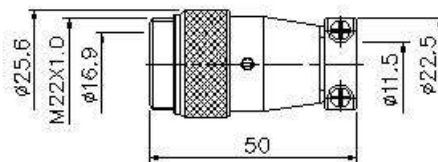

PLS-20-GPF

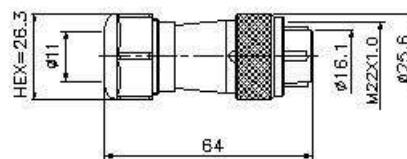

PLS-20-PF



PLS-24-PF

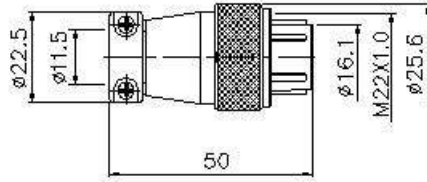

PLS-20-RCa



PLS-20-RCa

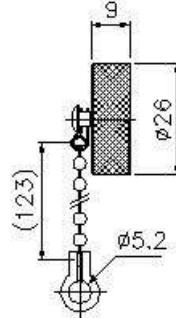

PLS-20-RM



PLS-20-RM

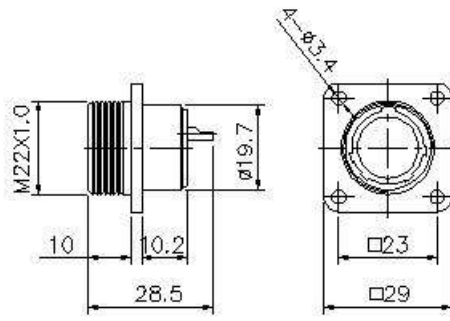

No. of contacts

Contacts
Cofiguration

Rated current/voltage

Operation limit voltage (AC.V.rms)

Withstanding voltage (AC.V.rms) 1 minute

Insulation resistance (MΩ MIN.) at DC 500V

Contact resistance (MΩ MAX.) AT DC 1A

Pin diameter (Ømm)

	2	3	4	7
Rated current/voltage	15A 250V	15A 250V	10A 250V	10A 250V
Operation limit voltage (AC.V.rms)	250	250	250	250
Withstanding voltage (AC.V.rms) 1 minute	1500	1500	1500	1000
Insulation resistance (MΩ MIN.) at DC 500V	2000	2000	2000	2000
Contact resistance (MΩ MAX.) AT DC 1A	3	3	3	3
Pin diameter (Ømm)	1.8	1.8	1.6	1.6