

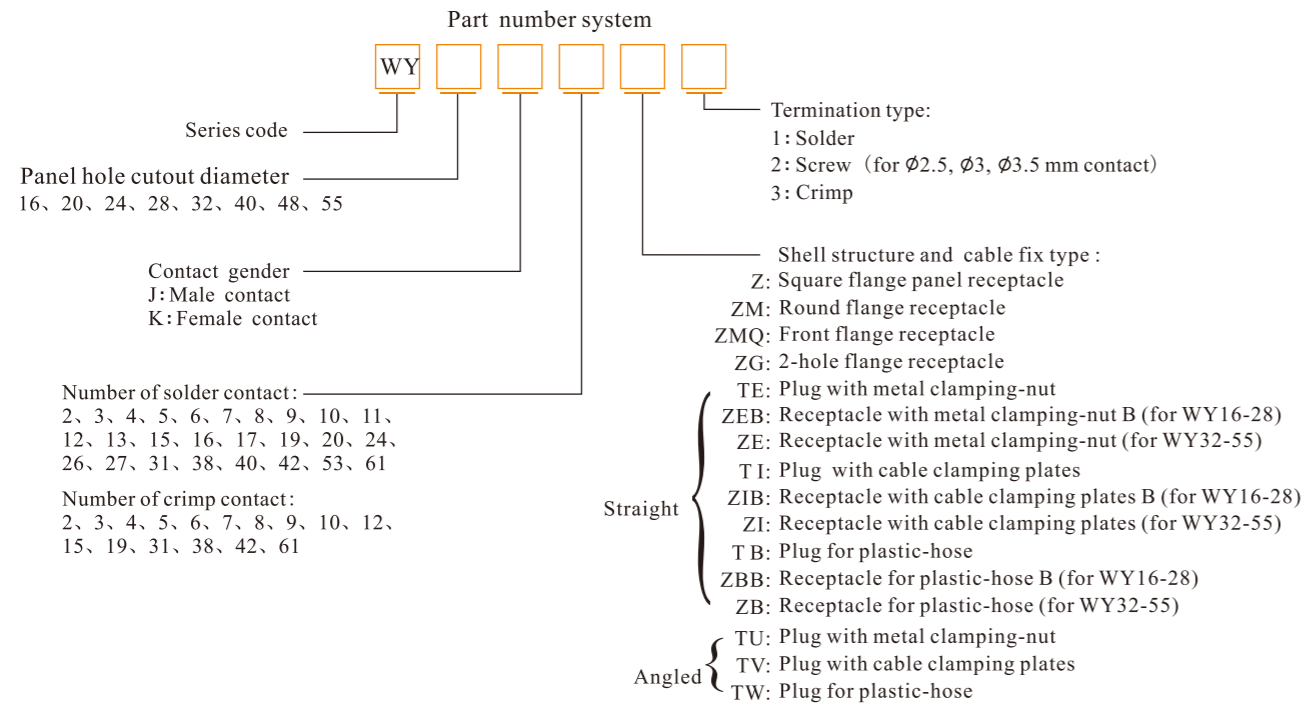

● **WY Series**



● **Remarks :** The rated current decreases according to the number of contacts, more contacts, less rated current.

Number of contact	1-3	4-10	11-20	21-30	31-40	41-50	51-61
Rated current decrease rate (%)	0	10	20	30	40	50	60

Material and spec

Coupling	Bayonet
Shell material	Zinc alloy with chrome plating
Insert material	PPS, max temperature 260 °C
Contact material	Brass with gold plating
Termination	Solder: $\phi 1, \phi 1.5, \phi 2.5, \phi 3.5, \phi 5, 5$ mm; Screw: $\phi 2.5, \phi 3, \phi 3.5$ mm; Crimp: $\phi 1, \phi 1.5, \phi 2.5, \phi 3.5, \phi 5.5, \phi 10$ mm
Mating cycle	500
Temperature range	-40°C ~ +85°C

★ Each side can be male or female contact ★ Solder contact spec see page 105-106
 ★ Crimp contact spec see page 107-110 ★ Screw contact spec see page 111-112

WY Series Mating diagram

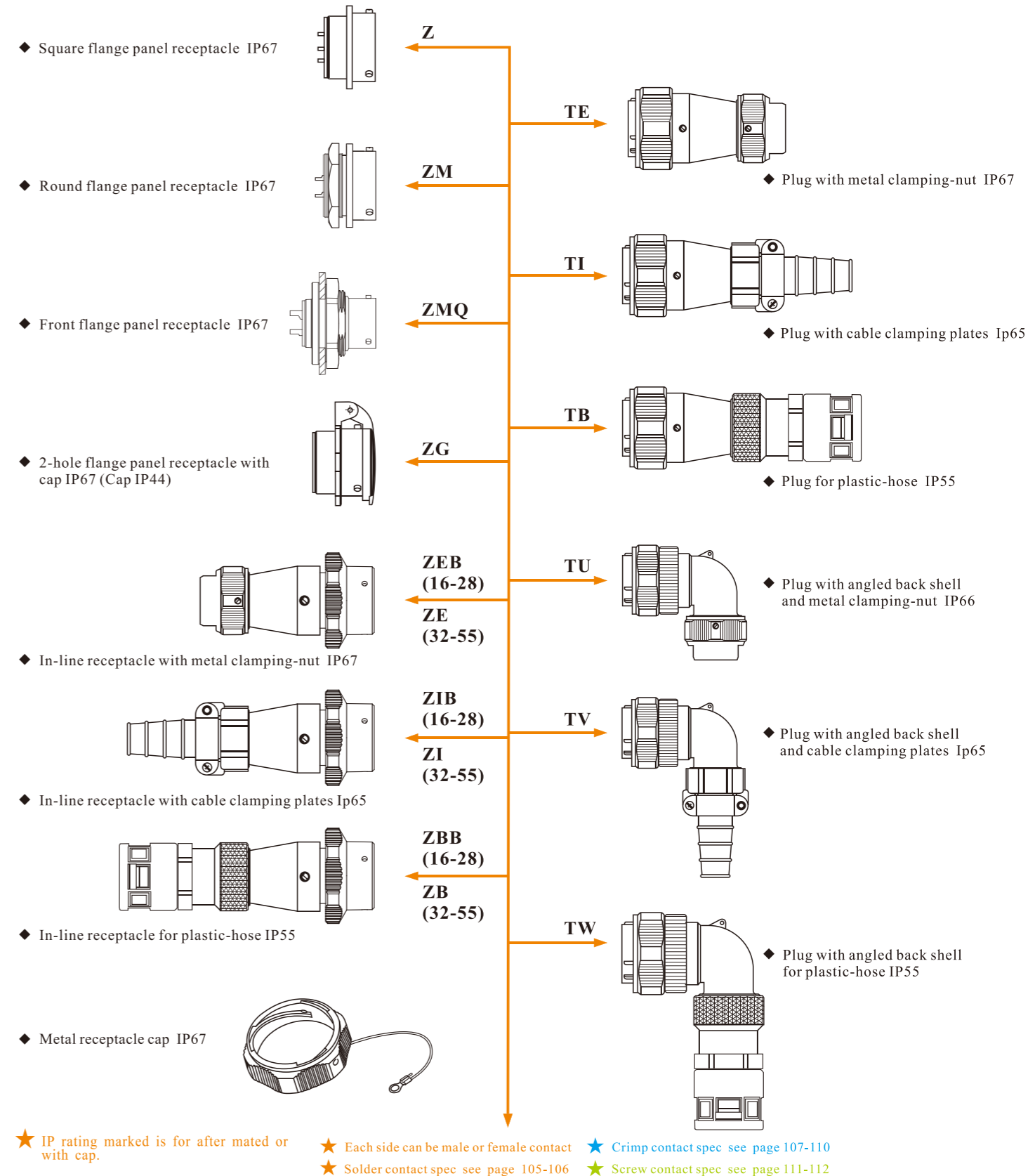



● Square flange panel receptacle: Z IP67

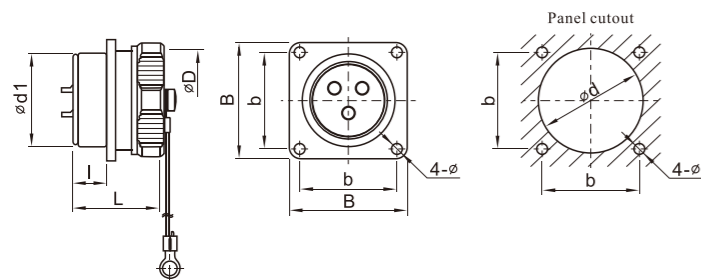

Dimension(mm)	WY16	WY20	WY24	WY28	WY32	WY40	WY48	WY55
d1	15.8	19.8	23.8	27.8	31.8	40	47.8	54.8
D	18	22	26	30	35	44	52	59
l	9.7	9.8	10	9.8	14.4	14.2	14.2	14
L	21.6	23	23	23	34	33.5	34	34
b	20	22	26	30	32	40	48	52
B	26	29	32	36	42	50	58	64
d	16.5	20.5	24.5	28.5	32.5	40.5	48.5	55.5
∅	3.2	3.2	3.2	3.2	3.5	4.5	4.5	4.5

● Round flange panel receptacle: ZM IP67

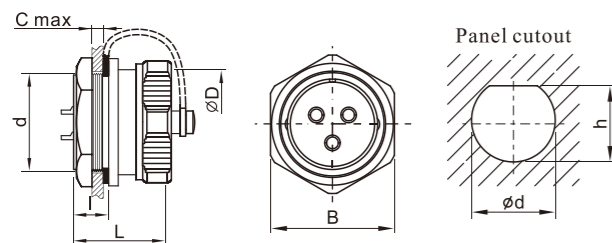

Dimension(mm)	WY16	WY20	WY24	WY28
d	M16X1	M20X1	M24X1	M28X1
D	18	22	26	30
C	5	5	5	5
l	9.7	9.9	10	10.2
L	22	23	23	23
B	21.2	25.5	29.2	33.3
∅d	15.9	19.9	23.9	27.9
h	15.3	19.3	23.2	26.9



● Front-nut-mount receptacle: ZMQ IP67

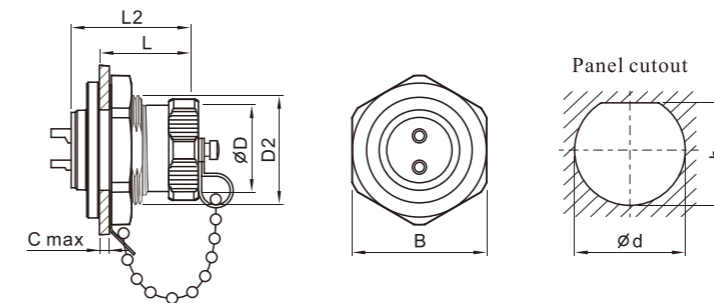





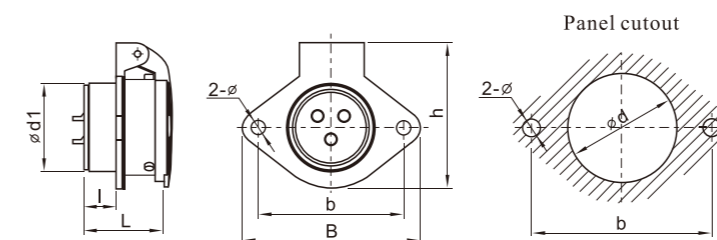





Dimension(mm)	WY16	WY20	WY24	WY28
D	18	22	26	30
D2	M22X1	M26X1	M30X1	M34X1
L	16	17	17	17
L2	21.6	23	23	23
C	5	5	5	5
B	26.8	30.8	34.8	38.8
∅d	22	26	30	34
h	20.6	24.6	28.6	32.6

● 2-hole flange panel receptacle with cap: ZG IP67 (Cap IP44)



Dimension(mm)	WY16	WY20	WY24	WY28	WY32	WY40	WY48	WY55
d1	15.8	19.8	23.8	27.8	31.8	39.8	47.8	54.8
d	16.5	20.5	24.5	28.5	32.5	40.5	48.5	55.5
l	10	10	10	10	15.4	14.7	14.3	14
L	22	23	23	23	34	34	34	34
b	30	35	40	45	55	65	80	85
B	38	44	50	55	67	77	92	98
h	32.5	36.5	40.5	45.5	52.5	63.5	74.5	80
∅	3.5	4.5	4.5	4.5	5.5	5.5	5.5	6.5

Solder contact spec

WS16、WF16、WY16	2	3	4	2B	3B	4B	5	7	9	10
Male contact face view										
Rated current (A)	10	10	5	15	15	15	5	5	5	5
Contact diameter(mm)	∅1.5X2	∅1.5X3	∅1X4	∅2X2	∅2X3	∅2X4	∅1X5	∅1X7	∅1X9	∅1X10
Rated voltage (AC.V)	500	500	500	500	500	500	500	400	400	400
Test voltage(AC.V) 1 min	1500	1500	1500	1500	1500	1500	1500	1200	1200	1200
Contact resistance(mΩ)	2.5	2.5	5	2.5	2.5	2.5	5	5	5	5
Insulation resistance (MΩ)	2000	2000	2000	2000	2000	2000	2000	2000	2000	2000
Wire size (mm ² /AWG)	≤2/14	≤2/14	≤0.75/18	≤2/14	≤2/14	≤2/14	≤0.75/18	≤0.75/18	≤0.75/18	≤0.75/18