

BOM LIST			
ITEM	PART NAME	Q'ty	NOTES
1	PLASTIC HOOD	2	ABS
2	2.1 LONG BOLT	2	#4-40
	2.2 SHORT BOLT	2	#4-40
3	NUT	2	M3
4	LONG SCREW	2	M3
5	SMALL WASHER	2	
6	SHORT SCREW	2	M3
7	METAL WASHER	2	M3

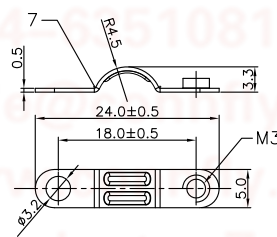
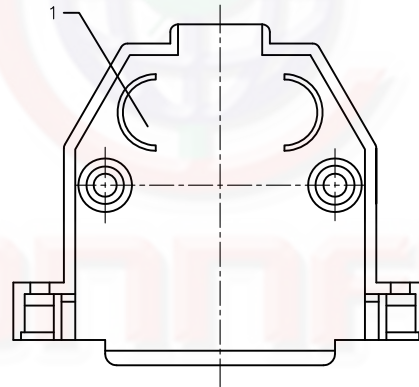
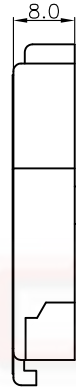

Metal

REV.	DESCRIPTION	DRAWN	CHECKED	APPROVED
A	NEW RELEASE	LJH 10/26/05'	~	LJC 10/26/05'
B	整理图面	YCH 09/13/07'	~	LJC 09/13/07'
D	DRAWING UPDATE	JLZ 05/19/16'	HZW 05/19/16'	LJC 05/19/16'
E	DRAWING UPDATE	JLZ 05/23/18'	~	

NOTES:

1. PART NUMBER CODE:

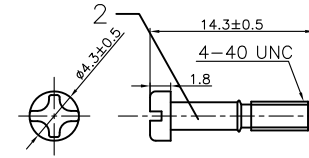
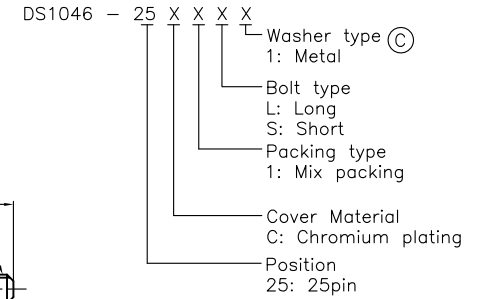

Short BOLT

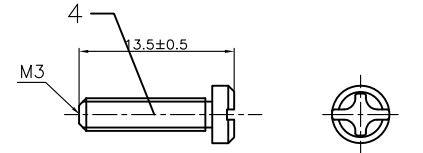

LONG SCREW

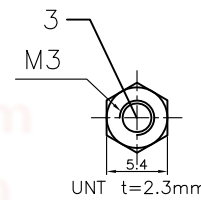

UNT t=2.3mm

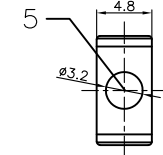

SMALL WASHER

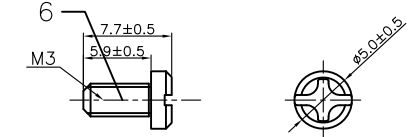

SHORT SCREW

GENERAL TOLERANCE		ANGLE TOLERANCE	
X.	±0.60	X.	±5°
.X	±0.38	.X	±3°
.XX	±0.25	.XX	±2°

PROJECTION	TITLE
UNITS	D-SUB 25pin Hood Chromium plated
SHEET SIZE	SERIES DS1046 SERIES

DRAWING TYPE	COSTOMER		
SCALE	1:1	SHEET	1 OF 1
DRAWING NO.	C-DS1046-25XXXX-E		

 晨翔电子有限公司
CONNFLY CONNFLY ELECTRONIC CO. LTD