

1
RoHS Compliance

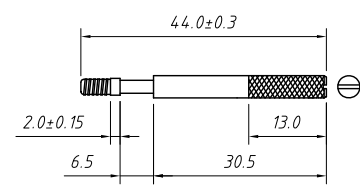
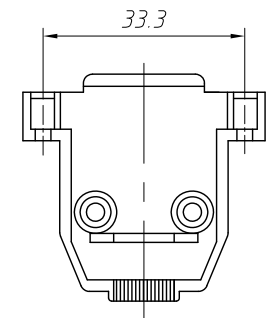
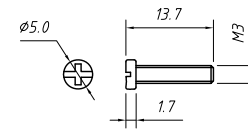
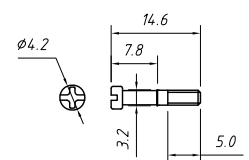
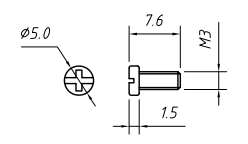
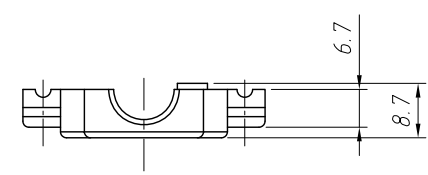
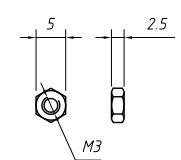
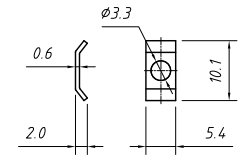
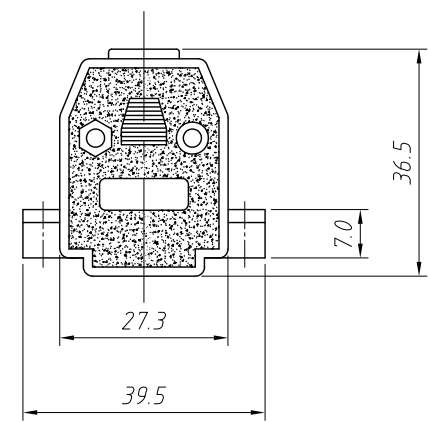
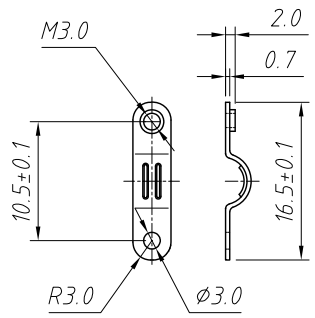

Order Information:
L-KLS1-DB-15P-S-G
 L: RoHS
 XXP-No.of
 09,15,25,37,50pins
 Screw:S-Short screw
 L-Long screw
 Color: G-Gray B-Black

Cover Material: ABS Plastic
 Screw Material: STEEL

ANGLE TOLERANCE	PROJECTION	Description:	
±3°		D-SUB HOOD PLASTIC MATERIAL (09-37Pin)	
GENERAL TOLERANCE	UNITS	mm	KLS P/N:
x.x ±0.30	SHEET SIZE	A4	L-KLS1-DB-15P-S-G
x.xx ±0.20	Draw:	Daniel	2020-11-11
x.xxx ±0.10	Check:	Daniel	2020-11-11

