

| | |
|------|---|
| Dept | |
| Qty | |
| DC | 1 |
| ED | 1 |
| IE | 1 |
| ISO | 1 |
| PD | 1 |
| R&D | 1 |
| SD | 1 |
| QA | 1 |
| QC | 1 |
| QE | 1 |

The information provided herein is from CONNFLY Electronic Co., Ltd. and is confidential. Any disclosure to a party other than the recipient is prohibited. The intellectual properties and its rights are strictly reserved by CONNFLY Electronic Co., Ltd. All intellectual properties provided herein are for reference purposes only and does not constitute authorization of its use in any format or manner. CONNFLY may enforce its intellectual property rights at its own discretion; failures or delays to exercise such rights does not constitute a waiver of such rights.

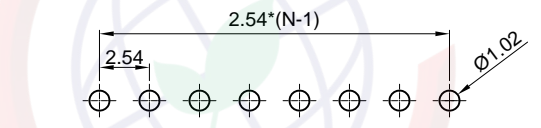

Recommend PCB layout
(Tolerance:±0.05)

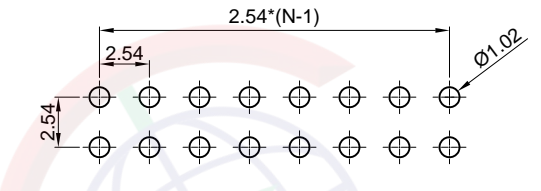
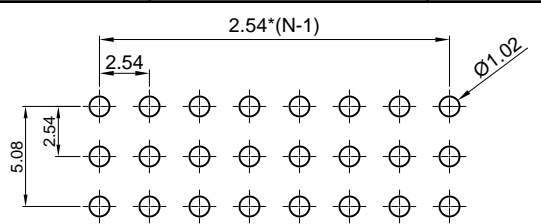
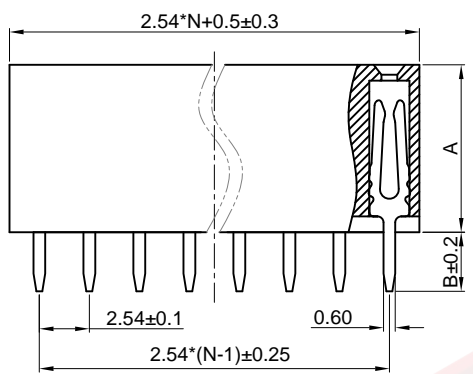
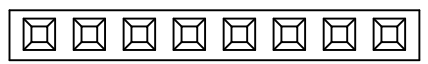
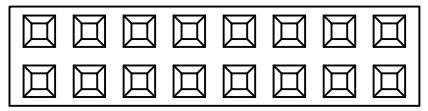
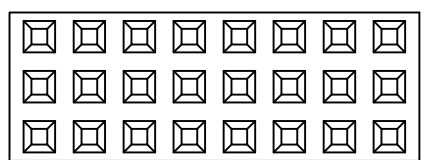
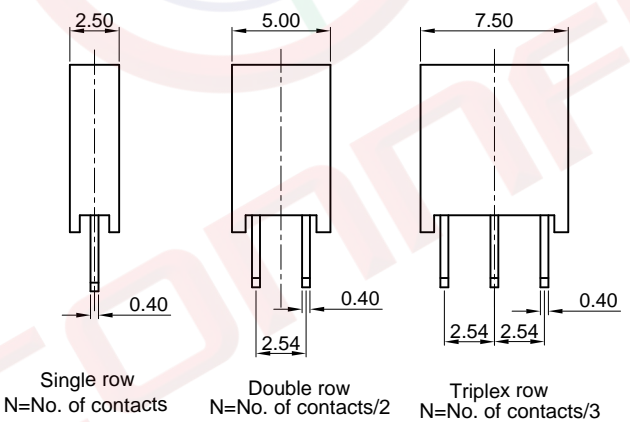

| DIM A | DIM B |
|-------|-------|
| 8.5 | 3.0 |
| 5.0 | 3.3 |

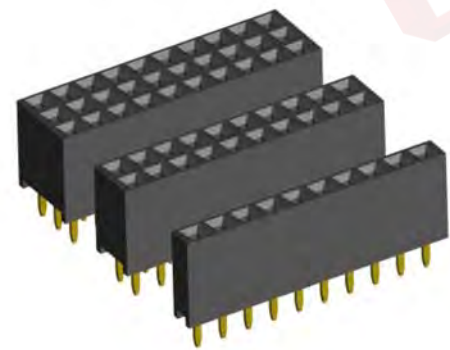

(Series Image-Reference Only)

| REV. | DESCRIPTION | DRAWN | CHECKED | APPROVED |
|------|----------------|---------------|---------------|---------------|
| A | NEW RELEASE | YCH 10/22/09' | | LJC 10/22/09' |
| B | DRAWING UPDATE | JLZ 02/10/15' | HZW 02/10/15' | LJC 02/10/15' |
| C | DRAWING UPDATE | JLZ 12/26/18' | | |

- Notes:
Specifications:
1. Contact Resistance: 20mΩ Max.
2. Insulation Resistance: 1000MΩ Min.
3. Dielectric Withstanding Voltage: 600V AC(rms) For 1 Minute.
4. Current Rating:3A.
5. Temperature: -40°C~+105°C.
Materials:
1. Contact Material: Copper Alloy.
2. Contact Plating: Gold Plating Over Nickel.
3. Insulator Materials: PBT or PA-9T,Black,UL94-V0.
Product Number Code:

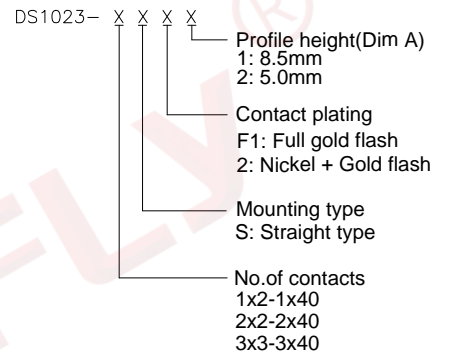

| | | | | | | | | |
|-------------------|-------|------------------|-----|--|----|----------|----------------------|--|
| GENERAL TOLERANCE | | ANGLE TOLERANCE | | PROJECTION | | TITLE | 2.54mm Female Header | |
| X. | ±0.60 | X. | ±5° | UNITS | mm | V/T Type | | |
| .X | ±0.38 | .X | ±3° | SHEET SIZE | A4 | SERIES | DS1023 SERIES | |
| .XX | ±0.25 | .XX | ±2° | 晨翔电子有限公司 CONNFLY CONNFLY ELECTRONIC CO. LTD | | | | |
| DRAWING TYPE | | CUSTOMER | | | | | | |
| SCALE | | 1:1 SHEET 1 OF 1 | | | | | | |
| DRAWING NO. | | C-DS1023-XXXX-C | | | | | | |